

# **ERCOT Operating Guides**

**July 1, 2009**

---

**PUBLIC**

**ERCOT Operating Guides  
Table of Contents**

**July 1, 2009**

---

<b>1. Introduction.....</b>	<b>1-3</b>
1.1 Document Purpose .....	1-3
1.2 Document Relationship.....	1-5
1.3 Process for Operating Guide Revision.....	1-6
1.4 Market Overview .....	1-17
1.5 Conformance to NERC Policies, Procedures, and Reliability Standards .....	1-19
1.6 Operating Definitions.....	1-22
1.7 Entity Definitions and Roles .....	1-24
1.7.1 ERCOT Control Area Authority .....	1-24
1.7.2 Qualified Scheduling Entities .....	1-24
1.7.3 Transmission Operator (TO).....	1-24
1.7.4 Resource Entity .....	1-25
1.7.5 Load Serving Entities (LSE) .....	1-26
1.8 Operational Training.....	1-27
1.8.1 Operator Training Objectives.....	1-27
1.8.2 System Operator Training Requirements.....	1-27
1.8.3 ERCOT Operations Training Seminar.....	1-28
1.8.4 ERCOT Black Start Training.....	1-28
1.8.5 ERCOT Severe Weather Drill.....	1-28
1.8.6 Criteria For The Selection Of Operators.....	1-28
1.8.7 Training Practices .....	1-29
1.9 Document Revisions .....	1-30
<b>2. System Operations.....</b>	<b>2-5</b>
2.1 Operational Duties .....	2-5
2.2 System Monitoring and Control .....	2-7
2.2.1 Overview .....	2-7
2.2.2 Security Criteria.....	2-8
2.2.3 Automatic Generation Control Systems .....	2-9
2.2.4 Automatic Voltage Regulators and Power System Stabilizers .....	2-11
2.2.5 Turbine Speed Governors .....	2-11
2.2.6 Performance/Disturbance/Compliance Analysis .....	2-12
2.2.7 Time Error and Time Synchronization .....	2-12
2.3 Dispatch Duties.....	2-14
2.3.1 Control Area Operator Authority.....	2-14
2.3.2 Dispatch Instruction Procedures .....	2-15
2.4 Scheduling.....	2-18
2.4.1 Day Ahead Scheduling .....	2-18
2.4.2 Adjustment Period Scheduling Process .....	2-20
2.4.3 Direct Current Tie Interconnection Day Ahead Scheduling Process.....	2-21
2.4.4 Temporary Deviations from Scheduling Procedures .....	2-22
2.4.5 Real-Time Schedules .....	2-23
2.5 Ancillary Services.....	2-31
2.5.1 ERCOT Responsibilities.....	2-31
2.5.2 Responsive Reserve .....	2-35
2.5.3 Non-Spinning Reserve Service (NSRS) .....	2-39
2.5.4 Replacement Reserve Service (RPRS) .....	2-39

2.5.5	Balancing Energy Service .....	2-40
2.6	Changes in System Status .....	2-43
2.6.1	Changes in Resource Status .....	2-43
2.6.2	Changes in Transmission Facility Status .....	2-43
2.7	Outage Coordination .....	2-44
2.7.1	ERCOT Control Area Authority Responsibilities .....	2-44
2.7.2	Forced Outages .....	2-44
2.7.3	Scheduled Outages .....	2-45
2.8	Congestion Management .....	2-47
2.8.1	Overview of ERCOT Coordinated Congestion Management .....	2-47
2.9	Requirements for Under-Frequency Relaying .....	2-49
2.9.1	Automatic Firm Load Shedding .....	2-49
2.9.2	Generators .....	2-50
2.10	System Voltage Profile .....	2-51
2.10.1	Introduction .....	2-51
2.10.2	Maintaining Voltage Profile .....	2-51
2.10.3	Special Consideration for Nuclear Power Plants .....	2-52
2.10.4	Reactive Considerations for Gas and Steam Turbine Power Plants .....	2-53
2.11	External Control Area Inter-Ties .....	2-54
2.11.1	Control Area Operations .....	2-54
2.11.2	Operation of DC Ties .....	2-54
2.12	Document Control .....	2-55
<b>3.</b>	<b><i>Operational Interfaces</i></b> .....	<b>3-4</b>
3.1	System Control Interfaces with ERCOT .....	3-4
3.1.1	Introduction .....	3-4
3.1.2	Compliance with Dispatch Instructions .....	3-4
3.1.3	Qualified Scheduling Entities .....	3-6
3.1.4	Power Generation Companies .....	3-11
3.1.5	Transmission and/or Distribution Service Providers .....	3-25
3.1.6	Responsibility For Equipment Ratings .....	3-28
3.2	Scheduling Interfaces with ERCOT .....	3-29
3.2.1	Scheduling-Related Duties of Qualified Scheduling Entities .....	3-29
3.2.2	Scheduling Process .....	3-31
3.2.3	Procurement of Replacement Reserve Service Resources .....	3-33
3.2.4	Procurement of Additional Ancillary Services .....	3-33
3.2.5	Direct Current Tie Interconnection Day Ahead Scheduling Process .....	3-34
3.2.6	Dynamic Schedules .....	3-34
3.2.7	Approval of the Use of Responsibility Transfer (RspT) Schedules .....	3-35
3.3	Document Control .....	3-38
<b>4.</b>	<b><i>Emergency Operation</i></b> .....	<b>4-4</b>
4.1	Introduction .....	4-4
4.2	Emergency Notifications .....	4-5
4.2.1	Operating Condition Notice .....	4-5
4.2.2	Advisory .....	4-6
4.2.3	Watch .....	4-7
4.2.4	Emergency Notice .....	4-9

4.3	Operation To Maintain Transmission System Security .....	4-11
	4.3.1 Remedial Action Plans.....	4-13
4.4	Block Load Transfers between ERCOT and Non-ERCOT Control Areas.....	4-14
	4.4.1 Introduction and General Information .....	4-15
	4.4.2 BLTs to ERCOT .....	4-15
	4.4.3 BLTs from ERCOT.....	4-16
4.5	Energy Emergency Alert (EEA) .....	4-17
	4.5.1 General .....	4-20
	4.5.2 Operating Procedures.....	4-20
	4.5.3 Implementation .....	4-21
4.6	Black Start.....	4-26
	4.6.1 Principles.....	4-27
	4.6.2 Strategies.....	4-27
	4.6.3 Priorities.....	4-28
	4.6.4 Responsibilities .....	4-28
	4.6.5 Emergency Back Up Communication Facilities Criteria.....	4-30
4.7	Document Control.....	4-31
	Attachment 4A: Detailed Black Start Information .....	4-33
	4A.1 CONSIDERATIONS FOR SYSTEM RESTORATION.....	4-33
	4A.2 ERCOT COORDINATION .....	4-37
	4A.3 Considerations For Black Start Testing .....	4-38
	4A.4 Criteria for ERCOT and Transmission Operator Black Start Plans.....	4-38
<b>5</b>	<b><i>Planning</i></b> .....	<b>5-3</b>
5.1	Planning Criteria .....	5-3
	5.1.1 Introduction.....	5-3
	5.1.2 Load Forecasts .....	5-4
	5.1.3 Resource Capability .....	5-4
	5.1.4 Transmission Reliability Testing .....	5-4
	5.1.5 Reports Of Testing.....	5-6
	5.1.6 System Modeling Information .....	5-6
	5.1.7 ERCOT Clarifications and Definitions of NERC Planning Standards Contingency Types C and D .....	5-12
5.2	Document Control.....	5-14
<b>6</b>	<b><i>Reports and Forms</i></b> .....	<b>6-3</b>
6.1	Reports .....	6-3
	6.1.1 Disturbance Report .....	6-3
	6.1.2 Relay Misoperation Report.....	6-4
6.2	Forms .....	6-5
	6.2.1 Turbine Governor Speed Regulation Tests.....	6-5
	6.2.2 Seasonal Unit Net Real Power Capability Verification.....	6-18
	6.2.3 Biennial Unit Reactive Limits (Lead and Lag) Verification .....	6-20
	6.2.4 Seasonal Hydro Responsive Reserve Net Capability Verification.....	6-24
	6.2.5 Annual LaaR Telemetry Test.....	6-25
	6.2.6 Biennial Test for LaaRs Providing Responsive Reserve Service .....	6-26
6.3	Document Control.....	6-31

<b>7</b>	<b><i>Disturbance Monitoring and System Protection</i></b> .....	<b>7-3</b>
7.1	Disturbance Monitoring Requirements.....	7-3
	7.1.1 Introduction.....	7-3
	7.1.2 Fault Recording Equipment.....	7-3
	7.1.3 Dynamic Disturbance Recording Equipment.....	7-6
	7.1.4 Equipment Reporting Requirements.....	7-6
	7.1.5 Review Process.....	7-6
7.2	System Protective Relaying.....	7-7
	7.2.1 Introduction.....	7-7
	7.2.2 Design and Operating Requirements for ERCOT System Facilities.....	7-7
	7.2.3 Performance Analysis Requirements for ERCOT System Facilities.....	7-10
	7.2.4 Maintenance and Testing Requirements for ERCOT System Facilities...	7-12
	7.2.5 Requirements and Recommendations for ERCOT System Facilities.....	7-12
7.3	Document Control.....	7-23
<b>8</b>	<b><i>Operational Metering and Communication</i></b> .....	<b>8-3</b>
8.1	Operational Metering.....	8-3
	8.1.1 ERCOT Interface RTUs.....	8-4
	8.1.2 ERCOT ICCP Interface.....	8-4
	8.1.3 Validation of Real Time Signals with Settlement Metering for Resources	8-4
	8.1.4 Data from ERCOT to QSE's.....	8-4
	8.1.5 Data From ERCOT to TDSP.....	8-5
	8.1.6 Data from QSE/TDSP to ERCOT.....	8-5
	8.1.7 TDSP/QSE Metering Restoration.....	8-8
	8.1.8 QSE and TDSP Data Acquisition.....	8-8
8.2	Calibration and Testing.....	8-8
	8.2.1 Responsibility.....	8-8
	8.2.2 Notification.....	8-8
	8.2.3 Test Equipment.....	8-9
	8.2.4 Disputes.....	8-9
	8.2.5 Calibration Testing.....	8-9
	8.2.6 Exchange of Information.....	8-9
	8.2.7 Documentation.....	8-9
	8.2.8 Operator One-line Displays.....	8-11
	8.2.9 Notification of Changes.....	8-11
8.3	Communications.....	8-12
	8.3.1 ERCOT WAN.....	8-12
	8.3.2 ERCOT Responsibilities.....	8-15
	8.3.3 QSE and TDSP Responsibilities.....	8-15
	8.3.4 TDSP and QSE Supplied Communications.....	8-17
	8.3.5 Maintenance and Restoration.....	8-17
8.4	Document Control.....	8-19
	Attachment 8A: ERCOT Data Sets.....	8-21

---

---

# ***ERCOT OPERATING GUIDES***

---

---

## **Section 1: Introduction**

---

---

### **Market Overview, Change Control, Relationships and Definitions**

July 1, 2009

**PUBLIC**

# Contents

<b>1. INTRODUCTION.....</b>	<b>1-3</b>
1.1 DOCUMENT PURPOSE .....	1-3
1.2 DOCUMENT RELATIONSHIP .....	1-5
1.3 PROCESS FOR OPERATING GUIDE REVISION .....	1-6
1.4 MARKET OVERVIEW.....	1-17
1.5 CONFORMANCE TO NERC POLICIES, PROCEDURES, AND RELIABILITY STANDARDS.....	1-19
1.6 OPERATING DEFINITIONS .....	1-22
1.7 ENTITY DEFINITIONS AND ROLES .....	1-24
1.7.1 ERCOT Control Area Authority.....	1-24
1.7.2 Qualified Scheduling Entities.....	1-24
1.7.3 Transmission Operator (TO).....	1-24
1.7.4 Resource Entity.....	1-25
1.7.5 Load Serving Entities (LSE).....	1-26
1.8 OPERATIONAL TRAINING.....	1-27
1.8.1 Operator Training Objectives .....	1-27
1.8.2 System Operator Training Requirements.....	1-27
1.8.3 ERCOT Operations Training Seminar.....	1-28
1.8.4 ERCOT Black Start Training .....	1-28
1.8.5 ERCOT Severe Weather Drill .....	1-28
1.8.6 Criteria For The Selection Of Operators.....	1-28
1.8.7 Training Practices.....	1-29
1.9 DOCUMENT REVISIONS.....	1-30

## Protocol References

REFERENCE: PROTOCOL SECTION 5.2.2, OPERATING STANDARDS.....	1-3
REFERENCE: PROTOCOL SECTION 6.10.5.4, RESPONSIVE RESERVE SERVICES DEPLOYMENT PERFORMANCE MONITORING CRITERIA (IN PART).....	1-21
REFERENCE: PROTOCOL SECTION 22, ATTACHMENT A, STANDARD FORM BLACK START AGREEMENT (IN PART) .....	1-26



# 1. Introduction

## 1.1 Document Purpose

These Electric Reliability Council of Texas (ERCOT) Operating Guides supplement the Protocols and describe the working relationship between the ERCOT Control Area Authority and entities within the ERCOT System that interact with the ERCOT Control Area Authority on a minute-to-minute basis to ensure the reliability and security of the ERCOT System, as shown in the following diagram:

Specific practices described in these Guides for the ERCOT System are consistent with the North American Electric Reliability Corporation (NERC) Operating Policies and Reliability Standards, the ERCOT Protocols and consist of the following Guides:

Section 1 - Introduction

Section 2 - System Operations

Section 3 - Operational Interfaces

Section 4 - Emergency Operation

Section 5 - Planning

Section 6 - Reports and Forms

Section 7 - Disturbance Monitoring and System Protection

Section 8 – Operational Metering and Communication

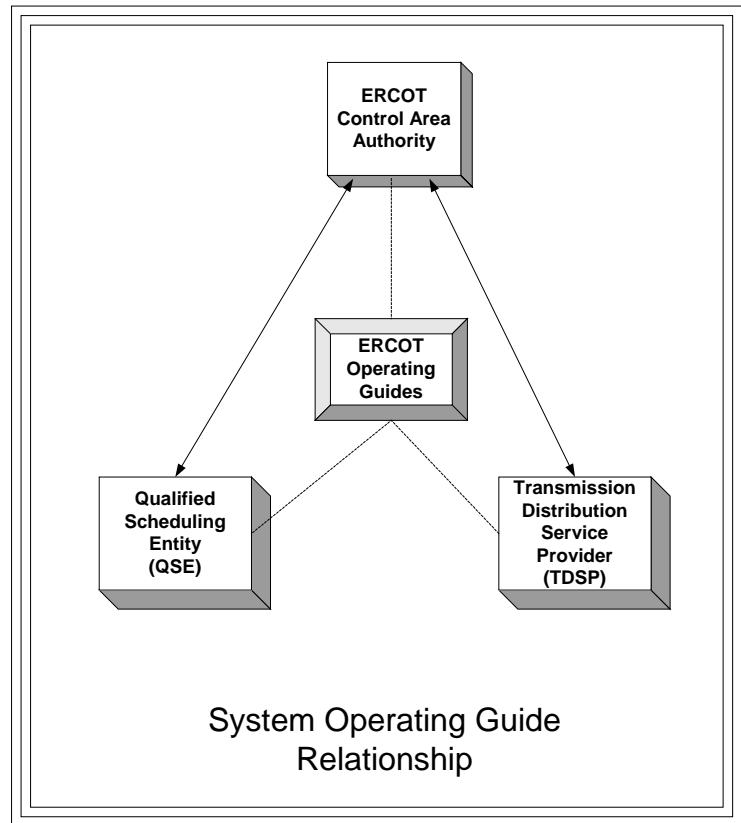

*REFERENCE: PROTOCOL SECTION 5.2.2, OPERATING STANDARDS*

*ERCOT and TDSPs shall operate the ERCOT System in compliance with Good Utility Practice and NERC and ERCOT standards, policies, guidelines and operating procedures. These Protocols shall control to the extent of any inconsistency between the Protocols and any of the following documents:*

- (1) *Any reliability guides applicable to ERCOT, including the Operating Guides;*

- (2) *The NERC Operating Manual and ERCOT procedures manual, supplied by NERC and ERCOT, respectively, as references for dispatchers to use during normal and emergency operations of the ERCOT Transmission Grid;*
- (3) *Specific operating procedures, submitted to ERCOT by individual transmission Facility owners or operators to address operating problems on their respective grids that could affect operation of the interconnected ERCOT Transmission Grid; and*
- (4) *Guidelines established by the ERCOT Board, which may be more stringent than those established by NERC for the secure operation of the ERCOT System.*

## 1.2 Document Relationship

The relationship of these Operating Guides to other documents is defined in the following diagram:

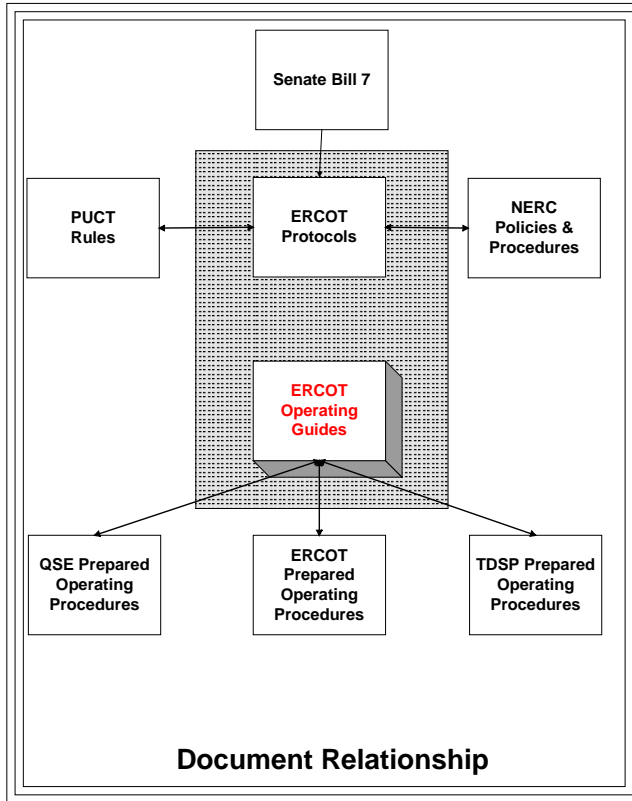

It is the responsibility of the ERCOT Control Area Authority to develop internal Operating Procedures. QSEs and TDSPs are required to develop their own internal Operating Procedures with respect to the ERCOT System entities, using their services and the Control Area Authority. However, in doing so, QSE and TDSP Operating Procedures shall incorporate the relevant requirements of these Operating Guides.

These Operating Guides are derived from the ERCOT Protocols and the NERC Policies, Procedures, and Reliability Standards. As the ERCOT system is within the State of Texas, the Public Utilities Commission of Texas (PUCT) defines additional requirements for the ERCOT Control Area Authority and connected entities.

PUCT requirements and directives and the ERCOT Protocols supercede these Guides. NERC Policies and Procedures, with the exception of the specific modifications defined in these Guides will also be followed.

## 1.3 Process for Operating Guide Revision

### 1.3.1 Introduction

- (1) A request to make additions, edits, deletions, revisions, or clarifications to these Operating Guides, including any attachments and exhibits to these Operating Guides, is called an Operating Guide Revision Request (OGRR). Except as specifically provided in other Sections of these Operating Guides, this Section shall be followed for all OGRRs. ERCOT Members, Market Participants, Public Utility Commission of Texas (PUCT) Staff, ERCOT Staff, and any other Entities are required to utilize the process described herein prior to requesting, through the PUCT or other Governmental Authority, that ERCOT make a change to these Operating Guides, except for good cause shown to the PUCT or other Governmental Authority.
- (2) All decisions of the Operations Working Group (OWG), as defined below, the Reliability and Operations Subcommittee (ROS), the Technical Advisory Committee (TAC) and the ERCOT Board of Directors (Board) with respect to any OGRRs shall be posted to the Market Information System (MIS) within three (3) Business Days of the date of the decision. All such postings shall be maintained on the MIS for at least one hundred-eighty days (180) days from the date of posting.
- (3) The “next regularly scheduled meeting” of the OWG, ROS, TAC, or the Board shall mean the next scheduled meeting for which required notice can be timely given regarding the item(s) to be addressed, as specified in the appropriate Board or committee procedures.
- (4) Throughout the Operating Guides, references are made to the ERCOT Protocols. ERCOT Protocols supersede the Operating Guides and any OGRRs must be compliant with the ERCOT Protocols. The ERCOT Protocols are subject to the revision process outlined in Protocol Section 21, Process for Protocol Revision.
- (5) ERCOT may make non-substantive corrections at any time during the processing of a particular OGRR. Under certain circumstances, however, the Operating Guides can also be revised by ERCOT rather than using the OGRR process outlined in this Section.
  - (a) This type of revision is referred to as an “Administrative OGRR” or “Administrative Change” and shall consist of non-substantive corrections, such as typos (excluding grammatical changes), internal references (including table of contents), improper use of acronyms, and references to ERCOT Protocols, PUCT Substantive Rules, the Public Utility Regulatory Act (PURA), North American Electric Reliability Corporation (NERC) regulations, Federal Energy Regulatory Commission (FERC) rules, etc. Updates to the ERCOT Load Shed Table in Section 4.5.3.3, EEA Levels, shall be processed as an Administrative OGRR.
  - (b) ERCOT shall post such Administrative OGRRs to the MIS and distribute the OGRR to the OWG at least ten (10) Business Days before implementation. If no interested party submits comments to the Administrative OGRR, ERCOT shall implement it according to Section 1.3.6, Operating Guide Revision Implementation. If any

interested party submits comments to the Administrative OGRR, then it shall be processed in accordance with the OGRR process outlined in this section.

### **1.3.1.1 Nodal Operating Guide Revision**

A request to make additions, edits, deletions, revisions, or clarifications to the Nodal Operating Guides, including any attachments and exhibits to the Nodal Operating Guides, is called a Nodal Operating Guide Revision Request (NOGRR). Except as specifically provided for in Section 1.3.4.1, Review and Posting of Operating Guide Revision Requests and Nodal Operating Guide Revision Requests, Section 1.3, Process for Operating Guide Revision, shall be followed for all NOGRRs. ERCOT Members, Market Participants, PUCT Staff, ERCOT Staff, and any other Entities are required to utilize the process described herein prior to requesting, through the PUCT or other Governmental Authority, that ERCOT make a change to the Nodal Operating Guides, except for good cause shown to the PUCT or other Governmental Authority.

### **1.3.2 Submission of an Operating Guide Revision Request**

The following Entities may submit an OGRR:

- (a) Any Market Participant;
- (b) Any Entity that is an ERCOT Member;
- (c) PUCT Staff;
- (d) ERCOT Staff; and
- (e) Any other Entity who resides (or represent residents) in Texas or operates in the ERCOT Region.

### **1.3.3 Operations Working Group**

- (1) ROS shall assign a working group ("Operations Working Group" or "OWG") to review and recommend action on formally submitted OGRRs. ROS may create such a working group or assign the responsibility to an existing working group provided that:
  - (a) Such working group's meetings are open to ERCOT Staff, ERCOT Members, Market Participants, and the PUCT Staff; and
  - (b) Each Market Segment is allowed to participate.
- (2) Where additional expertise is needed, the OWG may request that ROS refer an OGRR to existing subcommittees, working groups or task forces for review and comment on the OGRR. Suggested modifications—or alternative modifications if a consensus recommendation is not achieved by a non-voting working group or task force—to the OGRR shall be submitted by the chair or the chair's designee on behalf of the commenting

subcommittee, working group or task force as comments on the OGRR for consideration by OWG. However, the OWG shall retain ultimate responsibility for the processing of all OGRRs.

- (3) The OWG shall ensure that the Operating Guides are compliant with the ERCOT Protocols. As such, the OWG will monitor all changes to the ERCOT Protocols and initiate any OGRRs necessary to bring the Operating Guides in conformance with the ERCOT Protocols. The OWG will also initiate a Protocol Revision Request (PRR) if such a change is necessary to accommodate a proposed OGRR prior to proceeding with that OGRR.
- (4) ERCOT shall consult with the chair of the OWG to coordinate and establish the meeting schedule for the OWG or other assigned subcommittees. The OWG shall meet at least once per month, unless no OGRRs were submitted during the prior 24 days, and shall ensure that reasonable advance notice of each meeting, including the meeting agenda, is posted to the MIS.

### **1.3.4 Operating Guide Revision Procedure**

#### ***1.3.4.1 Review and Posting of Operating Guide Revision Requests and Nodal Operating Guide Revision Requests***

- (1) OGRRs shall be submitted electronically to ERCOT by completing the designated form provided on the MIS.
- (2) The OGRR shall include the following information:
  - (a) Description of requested revision;
  - (b) Reason for the suggested change;
  - (c) Impacts and benefits of the suggested change on ERCOT market structure, ERCOT operations, and Market Participants, to the extent that the submitter may know this information;
  - (d) OGRR Impact Analysis (IA) (applicable only for an OGRR submitted by ERCOT Staff);
  - (e) List of affected Operating Guide Sections and subsections;
  - (f) General administrative information (organization, contact name, etc.); and
  - (g) Suggested language for requested revision.
- (3) ERCOT shall evaluate the OGRR for completeness and shall notify the submitter, within five (5) Business Days of receipt, if the OGRR is incomplete, including the reasons for such status. ERCOT may provide information to the submitter that will correct the OGRR and render it complete. An incomplete OGRR shall not receive further consideration until it is

completed. In order to pursue the revision requested, a submitter must submit a completed version of the OGRR with the deficiencies corrected.

- (4) If a submitted OGRR is complete or once an OGRR is corrected, ERCOT shall post the complete OGRR to the MIS and distribute the OGRR to the OWG within three (3) Business Days.
- (5) Once a NOGRR has been determined to be complete, the NOGRR must be evaluated by the ERCOT Chief Executive Officer (ERCOT CEO) or his designee before posting to the MIS. The ERCOT CEO or his designee shall make his determination within five (5) Business Days or issue a Notice to the submitter advising them that additional time is necessary. Within three (3) Business Days after a determination by the ERCOT CEO or his designee, ERCOT shall notify the submitter of the NOGRR of the ERCOT CEO's or his designee's decision. If the ERCOT CEO or his designee determines the NOGRR is not necessary prior to the Texas Nodal Market Implementation Date, any ERCOT Member, Market Participant, PUCT Staff, or ERCOT Staff may appeal the decision directly to the ERCOT Board. Such appeal to the ERCOT Board must be submitted to ERCOT within ten (10) Business Days after the date of the ERCOT CEO's or his designee's decision.
- (6) Once a submitted NOGRR has been evaluated by the ERCOT CEO or his designee, ERCOT shall post the completed NOGRR and the ERCOT CEO's or his designee's decision to the MIS and distribute the NOGRR to the ROS within three (3) Business Days after the ERCOT CEO's or his designee's decision has been made.
- (7) Any posted NOGRR that changes scope during the stakeholder process must be reevaluated by the ERCOT CEO or his designee before proceeding to the next TAC Subcommittee, TAC, or the ERCOT Board for review.

#### ***1.3.4.2 Withdrawal of an Operating Guide Revision Request***

- (1) By providing notice to OWG, the submitter of an OGRR may withdraw the OGRR at any time prior to its recommendation for approval of the OGRR by the OWG. ERCOT shall post a notice of the submitter's withdrawal of an OGRR on the MIS within one Business Day of the submitter's notice to OWG.
- (2) The submitter of an OGRR may request withdrawal of an OGRR after a recommendation for approval by OWG. Such withdrawal must be approved by ROS (if it has not yet been considered by ROS) or by TAC (if it has been recommended for TAC approval by ROS but not yet considered by TAC).
- (3) Once approved by TAC, an OGRR cannot be withdrawn.

#### ***1.3.4.3 Operations Working Group Review and Action***

- (1) Any interested party may comment on the OGRR.

- (2) To receive consideration, comments must be delivered electronically to ERCOT in the designated format provided on the MIS within 21 days from the posting date of the OGRR. Comments submitted after the 21 day comment period may be considered at the discretion of OWG after these comments have been posted. Comments submitted in accordance with the instructions on the MIS, regardless of date of submission, shall be posted to the MIS and distributed electronically to the OWG within three Business Days of submittal.
- (3) The OWG shall review the OGRR at its next regularly scheduled meeting after the end of the 21 day comment period, unless the 21 day comment period ends less than three Business Days prior to the next regularly scheduled OWG meeting. In that case, the OGRR will be reviewed at the next regularly scheduled OWG meeting. At such meeting, the OWG may take action on the OGRR to:
  - (a) Recommend approval as submitted or modified;
  - (b) Recommend rejection;
  - (c) If no consensus can be reached, present options for ROS consideration;
  - (d) Defer action on the OGRR; or
  - (e) Request that ROS refer the OGRR to another subcommittee, workgroup, or task force.
- (4) Within three Business Days after OWG takes action (other than deferral), ERCOT shall issue a report (“OWG Recommendation Report”) to ROS reflecting the OWG’s action and post the same to the MIS. The OWG Recommendation Report shall contain the following items:
  - (a) Identification of submitter;
  - (b) Modified Operating Guide language proposed by the OWG, when appropriate;
  - (c) Identification of authorship of comments;
  - (d) Proposed effective date(s) of the OGRR;
  - (e) Recommended action; and
  - (f) Recommended priority and rank for any OGRRs requiring a system change project.

#### ***1.3.4.4 Comments to the Operations Working Group Recommendation Report***

- (1) Any interested party may comment on the OWG Recommendation Report. To receive consideration, comments on the OWG Recommendation Report must be delivered electronically to ROS and ERCOT in the designated format provided on the MIS. Comments received regarding the OWG Recommendation Report after three Business Days



prior to the next regularly scheduled OWG meeting may be considered at the discretion of the ROS chair.

- (2) Within three Business Days of receipt of comments related to the OWG Recommendation Report, ERCOT shall post such comments to the MIS. The comments shall include identification of the commenting Entity.
- (3) Comments submitted in accordance with the instructions on the MIS, regardless of date of submission, shall be posted to the MIS and distributed electronically to the ROS and OWG within three Business Days of submittal.
- (4) ROS shall review the OWG Recommendation Report and any posted comments to the Recommendation Report at its next regularly scheduled meeting. Comments must be posted seven days prior to the next regularly scheduled ROS meeting. Comments posted after the due date may be considered at the discretion of the ROS chair.

#### ***1.3.4.5 Operating Guide Revision Request Impact Analysis***

- (1) ERCOT shall complete an IA based on the submitted OWG Recommendation Report and will report the IA's results to OWG at the next regularly scheduled OWG meeting.
- (2) The IA shall include:
  - (a) An estimate of any cost and budgetary impacts to ERCOT;
  - (b) The estimated amount of time required to implement the proposed OGRR;
  - (c) The identification of alternatives to the original proposed language that may result in more efficient implementation; and
  - (d) The identification of any manual workarounds that may be used as an interim solution.

#### ***1.3.4.6 Operations Working Group Review of Impact Analysis***

- (1) After ERCOT posts the results of the IA, OWG shall review the IA at its next regularly scheduled meeting. OWG may revise its OWG Recommendation Report after considering the information included in the IA.
- (2) If OWG revises its Recommendation Report, a revised OWG Recommendation Report shall be issued by OWG to ROS and posted on the MIS. Additional comments received regarding the revised OWG Recommendation Report shall be accepted up to three Business Days prior to the ROS meeting at which the OGRR is scheduled for consideration. If OWG revises its recommendation, ERCOT shall update the IA and issue the updated IA at least three Business Days prior to the regularly scheduled ROS meeting. If a longer review

period is required for ERCOT Staff to update the IA, ERCOT Staff shall submit a schedule for completion of the IA to the ROS chair.

#### ***1.3.4.7 Reliability and Operations Subcommittee Vote***

- (1) ROS shall consider any OGRRs that OWG has submitted to ROS for consideration for which both a OWG Recommendation Report has been posted and an IA based on such OWG recommendation (as updated if modified by OWG under Section 1.3.4.6, Operations Working Group Review of Impact Analysis) has been posted on the MIS for at least three days. The following information must be included for each OGRR considered by ROS:
  - (a) The OWG Recommendation Report and IA; and
  - (b) Any comments timely received in response to the OWG Recommendation Report.
- (2) ROS shall take one of the following actions regarding the OWG Recommendation Report:
  - (a) Recommend approval of the OGRR as recommended in the OWG Recommendation Report or as modified by ROS;
  - (b) Reject the OGRR; or
  - (c) Remand the OGRR to the OWG with instructions.
- (3) If ROS recommends approval of an OGRR, ERCOT shall prepare a ROS Recommendation Report, issue the report to TAC and post the report on the MIS within three Business Days of the ROS recommendation concerning the OGRR. The ROS Recommendation Report shall contain the following items:
  - (a) Identification of the submitter of the OGRR;
  - (b) Modified Operating Guide language proposed by ROS;
  - (c) Identification of the authorship of comments;
  - (d) Proposed effective date(s) of the OGRR;
  - (e) Recommended priority and rank for any LPGRR requiring a change to ERCOT's computer systems;
  - (f) OWG recommendation; and
  - (g) ROS recommendation.

#### **1.3.4.8 *ERCOT Impact Analysis Based on Reliability and Operations Subcommittee Recommendation Report***

For OGRRs not designated Urgent, ERCOT shall review the ROS Recommendation Report and update the IA as soon as practicable, but no later than seven days prior to the next regularly scheduled TAC meeting, unless a longer period is warranted due to the complexity of the changes proposed by ROS. ERCOT shall issue the updated IA (if any) to TAC and post it on the MIS within three Business Days of issuance. If a longer review period is required for ERCOT Staff to update the IA, ERCOT Staff shall submit a schedule for completion of the IA to the ROS and TAC chairs.

#### **1.3.4.9 *PRS Review of Project Prioritization***

At its next regularly scheduled meeting, the PRS shall recommend to TAC an assignment of Project Priority for each OGRR recommended for approval by ROS that requires a change to ERCOT's computer systems.

#### **1.3.4.10 *Technical Advisory Committee Review and Action***

- (1) Upon recommendation for approval of an OGRR by ROS and issuance of an IA by ERCOT to TAC, TAC shall review the ROS Recommendation Report and the IA at its next regularly scheduled meeting; provided that the IA is available for distribution to the TAC at least seven days in advance of the TAC meeting.
- (2) TAC shall take one of the following actions regarding the ROS Recommendation Report:
  - (a) Approve the ROS Recommendation Report as originally submitted or as modified by TAC;
  - (b) Reject the ROS Recommendation Report; or
  - (c) Remand the ROS Recommendation Report to ROS with instructions.
- (3) If the ROS Recommendation Report is approved by TAC, as recommended by ROS or as modified by TAC, TAC shall review and approve or modify the proposed effective date.
- (4) If TAC approves an OGRR and it does not require an ERCOT project for implementation, or rejects an OGRR, ERCOT shall prepare a TAC Action Report and post it on the MIS within three Business Days. The TAC Action Report shall contain the following items:
  - (a) Identification of the submitter of the OGRR;
  - (b) Identification of the authorship of comments;
  - (c) Proposed effective date(s) of the OGRR;
  - (d) Procedural history;
  - (e) ROS recommendation; and
  - (f) TAC Action

- (5) The chair of TAC shall report the results of all votes by TAC related to OGRRs to the Board at its next regularly scheduled meeting.
- (6) TAC shall consider the Project Priority of each OGRR requiring a change to ERCOT's computer systems and make recommendations to the Board. If TAC recommends approval of an OGRR that requires an ERCOT project which can be funded in the current ERCOT budget cycle based upon its priority and ranking, ERCOT shall prepare a TAC Recommendation Report, issue the report to the Board and post the report on the MIS within three Business Days of the TAC recommendation concerning the OGRR. The TAC Recommendation Report shall contain the following items:
  - (a) Identification of the submitter of the OGRR;
  - (b) Modified Operating Guide language proposed by TAC, if applicable;
  - (c) Identification of the authorship of comments;
  - (d) Proposed effective date(s) of the OGRR;
  - (e) Priority and Rank of the OGRR;
  - (f) ROS recommendation; and
  - (g) TAC Recommendation.
- (7) If TAC recommends approval of an OGRR that requires a project for implementation that cannot be funded within the current ERCOT budget cycle, ERCOT shall prepare a TAC Recommendation Report and post the report on the MIS within three Business Days of the TAC recommendation concerning the OGRR. ERCOT shall assign the approved OGRR to the "Unfunded Project List" until the Board approves an annual ERCOT budget in a manner that indicates funding would be available in the new budget cycle to implement the project if approved by the Board; in such case, the TAC Recommendation Report would be provided at the next Board meeting following such budget approval for the Board's consideration under Section 1.3.4.11, ERCOT Board Review and Action.
- (8) Notwithstanding the above, an OGRR in the Unfunded Project List may be removed from the list and provided to the Board for approval, as set forth in Protocol Section 21.9, Review of Project Prioritization, Review of Unfunded Project List, and Annual Budget Process. ERCOT shall maintain the Unfunded Project List to track projects that cannot be funded in the current ERCOT budget cycle. Any OGRR approved by TAC but assigned to the Unfunded Project List may be challenged by appeal as set forth in Section 1.3.4.12, Appeal of Decision.

#### ***1.3.4.11 ERCOT Board Review and Action***

The Board shall review all OGRRs which impact ERCOT Systems or staffing and can be funded in the current ERCOT budget cycle based upon its priority and ranking. The Board shall take one of the following actions regarding OGRRs recommended by TAC which have such impacts:

- (a) Approve the TAC recommendation as originally submitted or as modified by the Board; or
- (b) Reject the TAC recommendation; or
- (c) Remand the TAC recommendation to TAC with instructions.

#### **1.3.4.12 Appeal of Decision**

- (1) With reference to a decision by OWG, any interested party may appeal directly to the ROS. Such appeal to the ROS must be submitted to ERCOT within ten Business Days after the date of the relevant decision. Appeals made after this time shall be rejected. Appeals to the ROS shall be posted on the MIS within three Business Days and placed on the agenda of the next available regularly scheduled ROS meeting, provided that the appeal is provided to ERCOT at least 11 days in advance of the ROS meeting; otherwise the appeal will be heard by the ROS at the next regularly scheduled ROS meeting.
- (2) With reference to a decision by ROS, any interested party may appeal directly to the TAC. Such appeal to the TAC must be submitted to ERCOT within ten Business Days after the date of the relevant decision. Appeals made after this time shall be rejected. Appeals to the TAC shall be posted on the MIS within three Business Days and placed on the agenda of the next available regularly scheduled TAC meeting, provided that the appeal is provided to ERCOT at least 11 days in advance of the TAC meeting; otherwise the appeal will be heard by the TAC at the next regularly scheduled TAC meeting.
- (3) With reference to a decision by TAC, any interested party may appeal directly to the Board. Such appeal to the Board must be submitted to ERCOT within ten Business Days after the date of the relevant decision. Appeals made after this time shall be rejected. Appeals to the Board shall be posted on the MIS within three Business Days and placed on the agenda of the next available regularly scheduled Board meeting, provided that the appeal is provided to the ERCOT General Counsel at least 11 days in advance of the Board meeting; otherwise the appeal will be heard by the Board at the next regularly scheduled Board meeting.
- (4) Any interested party may appeal any decision of the Board regarding the OGRR to the PUCT or other Governmental Authority. Such appeal to the PUCT or other Governmental Authority must be made within 35 days of the date of the relevant decision. If the PUCT or other Governmental Authority rules on the OGRR, ERCOT shall post the ruling on the MIS.

#### **1.3.5 Urgent Requests**

- (1) The party submitting an OGRR may request that the OGRR be considered on an urgent basis (“Urgent”) only when the submitter can reasonably show that an existing Operating Guide provision is impairing or could imminently impair ERCOT System reliability or wholesale or retail market operations, or is causing or could imminently cause a discrepancy between a settlement formula and a provision of the ERCOT Protocols..

- (2) If a submitter requests Urgent status for an OGRR, ROS may designate the OGRR for Urgent consideration if the ROS determines that such OGRR requires immediate attention due to:
  - (a) Serious concerns about ERCOT System reliability or market operations under the unmodified language; or
  - (b) The crucial nature of settlement activity conducted pursuant to any settlement formula; and
  - (c) Is of a nature that allows for rapid implementation without negative consequence to the reliability and integrity of the ERCOT System or market operations.
- (3) The Urgent OGRR and IA (if available) shall be considered at the earliest regularly scheduled OWG or ROS meeting, or at a special meeting called by the OWG or ROS chair to consider the Urgent OGRR.
- (4) If the submitter desires to further expedite processing of the OGRR, a request for ROS to vote via electronic mail may be submitted to the ROS chair. The ROS chair may grant the request for voting via electronic mail. Such voting shall be conducted pursuant to TAC procedures. If ROS recommends approval of the Urgent OGRR, ERCOT shall submit a ROS Recommendation Report to the TAC within three Business Days after ROS takes action. The TAC chair may request action from TAC to accelerate or alter the procedures described herein, as needed, to address the urgency of the situation.
- (5) Notice of an Urgent OGRR pursuant to this subsection shall be posted on the MIS.

### **1.3.6 Operating Guide Revision Implementation**

- (1) For OGRRs with no impact to ERCOT Systems or staffing, ERCOT shall implement OGRRs on the first day of the month following TAC approval, unless otherwise provided in the TAC Action Report for the approved OGRR.
- (2) For OGRRs with impacts to ERCOT Systems or staffing, ERCOT shall implement OGRRs on the first day of the month following Board approval, unless otherwise provided in the Board Action Report for the approved OGRR.
- (3) ERCOT shall implement an Administrative OGRR on the first day of the month following the end of the ten Business Day posting requirement outlined in Section 1.3.1, Introduction.

## 1.4 Market Overview

The Electric Reliability Council of Texas (ERCOT) is a not-for-profit, regulated Control Area Authority (CAA) and member of the North American Electric Reliability Corporation (NERC). The Public Utility Commission of Texas (PUCT) is the principal regulatory authority of ERCOT. The Federal Energy Regulatory Commission (FERC) has regulatory authority over the DC Tie Line and future interconnections between ERCOT and out of state entities.

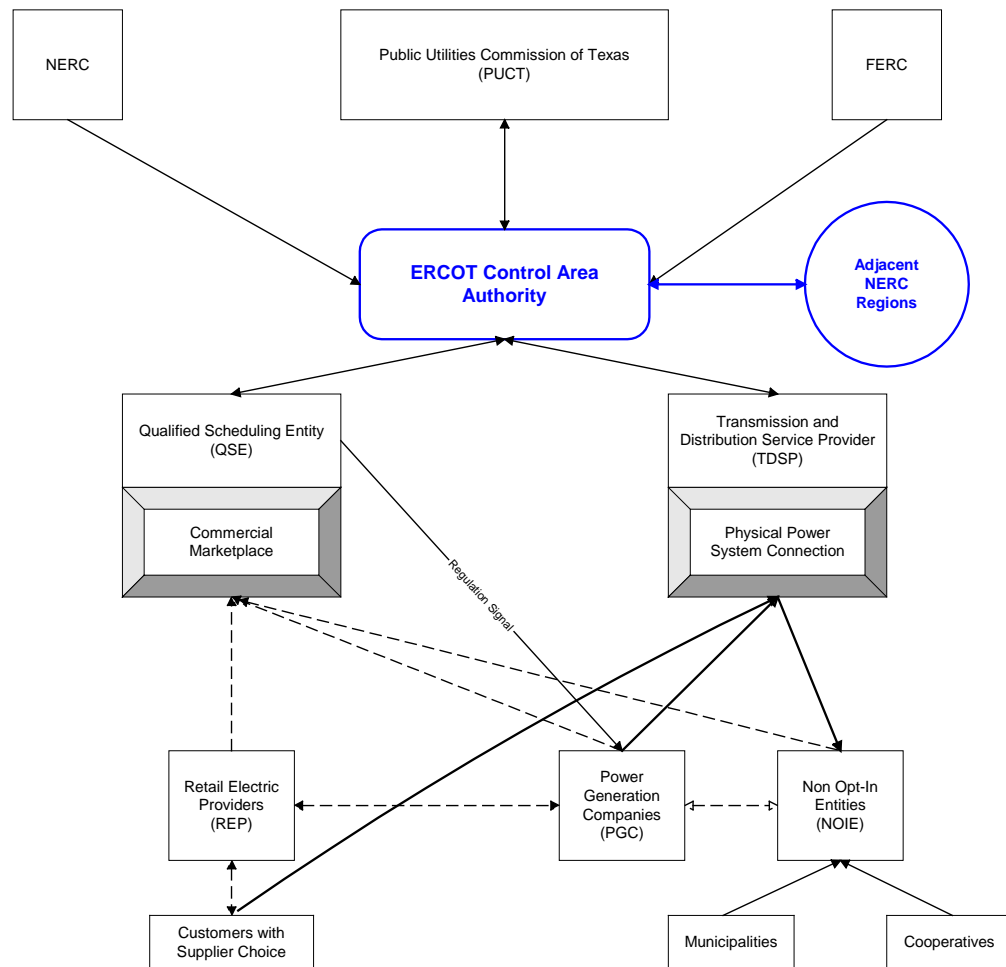

### ERCOT System Entity Relationships

The primary responsibility of the ERCOT Control Area Authority is to ensure secure and reliable power grid operation within the ERCOT System in accordance with NERC standards, where applicable and to facilitate the efficient use of the electric transmission system by the market participants.

The ERCOT System market is based on bilateral transactions between buyers and sellers. ERCOT will ensure that the power grid can accommodate market participant schedules. In addition, ERCOT Control Area Authority will monitor the power grid in real time and provide

ancillary services to resolve capacity shortfalls, transmission congestion and maintain reliability.

The ERCOT Control Area Authority only interacts directly with Qualified Scheduling Entities and Transmission and/or Distribution Service Providers to operate the ERCOT System in a reliable and secure manner.

The relationship between the entities is defined in Section 1.7, Entity Definitions and Roles.



## 1.5 Conformance to NERC Policies, Procedures, and Reliability Standards

The Electric Reliability Council of Texas (ERCOT) Operating Guides are for the purpose of outlining specific practices for the ERCOT System. These practices are consistent with the North American Electric Reliability Corporation (NERC) Operating Policies and standards. For application in ERCOT, some NERC Policies must be adapted to fit the unique characteristics of the ERCOT System. Specific necessary adaptations are listed below:

NERC Policy	ERCOT Adaptation
<b>Time and Frequency Control</b>	Sustained frequency deviations from 60 Hz result in time error.
<b>Time Error Monitoring</b>	ERCOT will monitor accumulated time error and initiate time corrections. The instantaneous time error is available to all ERCOT Qualified Scheduling Entities (QSEs) on the ERCOT website. When time error is equal to or greater than $\pm 3$ seconds, ERCOT may initiate a time correction. The correction will be ended when the error is less than $\pm 0.5$ seconds. The time correction may be postponed if it is determined that Load patterns in the immediate future will result in the desired time correction.
<b>Time Error Correction</b>	When a time correction is necessary, ERCOT will adjust scheduled frequency in the following manner. ERCOT will arrange for more or less Resources. Information to be passed along will include the correction frequency (59.98 Hz for fast and 60.02 Hz for slow) and the start time. A time correction may be terminated after five (5) hours, after any hour without a one-half (0.5) second error reduction. The Control Area Authority will provide adequate notice of ending the time correction.
<b>Inadvertent Interchange Management</b>	<p>The only Inadvertent Energy will be between ERCOT and Southwest Power Pool (SPP) and/or Comision Federal de Electricidad (CFE). Accounting / payback will be handled according to NERC policy.</p> <p>The hourly difference between a Control Area's actual net interchange and a Control Area's scheduled net interchange is classified as inadvertent energy.</p> <p>All inadvertent energy is placed in an Inadvertent Payback Account to be paid back in kind.</p>
<b>Control Surveys</b>	Not all of the surveys defined by NERC apply to a system the size of ERCOT and /or a single Control Area interconnection such as ERCOT.

NERC Policy	ERCOT Adaptation								
<b>Load Shedding and System Restoration</b>	<p data-bbox="548 239 1300 275">Automatic firm Load shedding will be initiated as follows:</p> <table data-bbox="548 310 1027 457"> <thead> <tr> <th data-bbox="548 310 688 346">Frequency</th> <th data-bbox="837 310 1027 346">% Load Relief</th> </tr> </thead> <tbody> <tr> <td data-bbox="565 348 672 384">59.3 Hz</td> <td data-bbox="935 348 985 384">5%</td> </tr> <tr> <td data-bbox="565 386 672 422">58.9 Hz</td> <td data-bbox="935 386 992 422">10%</td> </tr> <tr> <td data-bbox="565 424 672 459">58.5 Hz</td> <td data-bbox="935 424 992 459">10%</td> </tr> </tbody> </table> <p data-bbox="548 495 1455 1184">Load shedding will be widely dispersed in each Transmission and/or Distribution Service Provider (TDSP), with no preference to Load Serving Entities (LSEs), and will be accomplished by using high-speed under-frequency relays. The frequency measuring relays shall have a time delay of no more than thirty (30) cycles (or one-half (0.5) seconds for relays that do not count cycles). If the frequency and time values are reached, an irretrievable trip is initiated. Total time from the time when frequency first reaches one of the values specified above to the time Load is interrupted should be no more than forty (40) cycles, including all relay and breaker operating times. Under-frequency relays may be installed on Transmission Facilities under the direction of ERCOT, provided the relays are set at 58.0 cycles or below, are not directional, and have at least 2.0 seconds time delay. Load restoration will be under the direction of the ERCOT Control Area Authority. A TDSP may by mutual agreement, with the approval of the Technical Advisory Committee (TAC), arrange to have all or part of its automatic Load shedding obligation carried by another TDSP. ERCOT will be notified and provided with the details of any such arrangement prior to implementation.</p>	Frequency	% Load Relief	59.3 Hz	5%	58.9 Hz	10%	58.5 Hz	10%
Frequency	% Load Relief								
59.3 Hz	5%								
58.9 Hz	10%								
58.5 Hz	10%								

NERC Policy	ERCOT Adaptation
<p><b>Information Exchange – Disturbance Reporting</b></p>	<p>ERCOT will record the following data from the ERCOT System for frequency deviations of 0.175 Hz or greater and will use this information to generate the ERCOT initial Disturbance Report:</p> <ul style="list-style-type: none"> <li>➤ ERCOT and individual QSE control biases.</li> <li>➤ Net MW Capability (including any capability lost) at the time of the disturbance.</li> <li>➤ Net System Load (MW) for the hour ending closest to the time of the disturbance.</li> <li>➤ Scheduled Net Interchange (MW) at the time of the disturbance.</li> <li>➤ Amount of interruptible Load (MW) tripped.</li> </ul> <p><i>REFERENCE: PROTOCOL SECTION 6.10.5.4, RESPONSIVE RESERVE SERVICES DEPLOYMENT PERFORMANCE MONITORING CRITERIA (IN PART)</i></p> <p><i>...For all frequency deviations exceeding 0.175 Hz, ERCOT shall measure and record each two (2) second scan rate values of real power output for each QSE Resource providing Responsive Reserve Service. ERCOT shall measure and record the MW data beginning one (1) minute prior to the start of the frequency excursion event or Manual / Dispatch Instruction until ten (10) minutes after the start of the frequency excursion event or Manual / Dispatch Instruction...</i></p>
<p><b>Reliability Criteria</b></p>	<p>ERCOT operating reserve requirements are more restrictive than the concepts in the NERC Operating Manual.</p> <p>The ERCOT Responsive Reserve Obligation is a minimum of 2300 MW.</p>

## 1.6 Operating Definitions

A complete list of definitions is contained within Protocol Section 2, Definitions and Acronyms. The following definitions apply specifically to reliability and security operation.

It is essential to the reliability of the ERCOT System that all appropriate personnel use and understand the same terms in their daily operations. The definitions in this section are intended to enable the ERCOT Control Area Authority (CAA), Qualified Scheduling Entities (QSEs) and Transmission and/or Distribution Service Provider (TDSP) operators to effectively communicate on an ongoing basis.

<b>Capacitor</b>	Produces reactive power (VAR source) for voltage control and causes the system power factor to move towards a leading condition.
<b>Designated Agent</b>	Any Entity that is authorized to perform actions or functions on behalf of another Entity.
<b>Generator Reactive Power Sign/Direction Terminology</b>	<ol style="list-style-type: none"> <li>(1) Lagging power factor operating condition is when VAR flow is out of the generating unit (overexcited generator) and into the transmission system and is considered to be positive (+) flow, i.e., in the same direction as MW power flow. The generator is producing MVARs</li> <li>(2) Leading power factor operating condition is when VAR flow is into the generating unit (underexcited generator) and out of the transmission system and is considered to be negative (-) flow, i.e., in the opposite direction as MW power flow. The generator is absorbing MVARs.</li> </ol>
<b>Inadvertent Energy</b>	The difference between a Control Area's actual net interchange and a Control Area's scheduled net interchange.
<b>Interchange</b>	<ol style="list-style-type: none"> <li>a. Net Interchange The algebraic sum of the power flows of the ERCOT Control Area's interconnections with other Control Areas. Sign convention is that net interchange out of an area is positive while net interchange into an area is negative.</li> <li>b. Scheduled Net Interchange The mutually prearranged intended net power flow on the ERCOT Control Area's interconnections with other Control Areas.</li> </ol>
<b>Physical Responsive Capability (PRC)</b>	A representation of the total amount of system wide On-line capability that has a high probability of being able to quickly respond to system disturbances. The PRC shall be calculated by (i) determining each Resource meeting the requirements of Section 2.5.2.3, Types of Responsive Reserve, of these Guides, (ii) determining for each Resource the lesser quantity of the latest Net

Dependable Capability, the Resource Plan High Operating Limit (HOL), or the telemetered Real Time capability, (iii) multiplying the lesser quantity of each Resource by the Reserve Discount Factor (RDF), (iv) using that result to determine the amount of Responsive Reserve capability then available on each Resource, and (v) the sum, for all Resources, of the Responsive Reserve capability as determined for each Resource. The PRC shall be used by ERCOT to determine the appropriate Emergency Notification and Energy Emergency Alert (EEA) levels.

<b>Remedial Action Plan (RAP)</b>	Predetermined operator actions to maintain ERCOT Transmission Grid reliability during a defined adverse operating condition.
<b>Reserve Discount Factor (RDF)</b>	A representation of the average amount of system wide capability that, for whatever reason, is historically undeliverable during periods of high system demand. The RDF will be verified by ERCOT and then approved by the Reliability and Operations Subcommittee (ROS).
<b>Special Protection System (SPS)</b>	A protective relay system specially designed to detect abnormal system conditions and take pre-planned corrective action (other than the isolation of faulted elements) to provide acceptable system performance.
<b>Telemetry</b>	Equipment for measuring a quantity (e.g., amps, volts, MW, MVAR, MVA) and transmitting the result to a remote location for indication or recording.
<b>Time Error</b>	An accumulated time difference between ERCOT system time and the time standard. Time Error is caused by a deviation in ERCOT average frequency from 60.0 Hz.
<b>Transmission Service Provider (TSP)</b>	An Entity that owns or operates for compensation in this state, equipment or Facilities rated at 60 kV or higher used to transmit electricity, and whose rates for Transmission Service are set by the Public Utility Commission of Texas (PUCT).
<b>Transmission Line Terminal Sign/Direction Terminology</b>	<ol style="list-style-type: none"> <li>(1) MW or VAR flow out of the bus and into the line is considered to be positive (+) flow.</li> <li>(2) MW or VAR flow into the bus and out of the line is considered to be negative (-) flow.</li> </ol>

## 1.7 Entity Definitions and Roles

### 1.7.1 ERCOT Control Area Authority

The ERCOT Control Area Authority is the regional security coordinator for the ERCOT System and is responsible for all regional security coordination as defined in the NERC Operating Manual and applicable ERCOT Operating Manuals or Guides.

The ERCOT Control Area Authority will deploy all Ancillary Services and dispatch transmission in accordance with the ERCOT Protocols, to ensure operational security and to remedy all Commercially Significant Constraints (CSC) and Operational Constraints.

The ERCOT Control Area Authority shall operate the ERCOT Transmission Grid in compliance with Good Utility Practice, NERC, and ERCOT standards, policies, guidelines and operating procedures, including, but not limited to:

- These ERCOT Operating Guides;
- NERC Operating Manuals and Reliability Standards as references during normal and emergency operations of the ERCOT System Transmission Grid; and,
- Individual transmission owners Operating Procedures submitted to ERCOT Control Area Authority to identify specific operating problems that could affect operation of the interconnected ERCOT System Transmission Grid.

### 1.7.2 Qualified Scheduling Entities

Qualified Scheduling Entities (QSE) will provide the primary information interface for market participants with the ERCOT Control Area Authority. Market participants wishing to transfer energy or services during the operating hour from one participant to another, or from generation to load, or from the participant to ERCOT, or from ERCOT to the participant will submit Balanced Schedules to the ERCOT Control Area Authority through a Qualified Scheduling Entity.

QSEs are not regulated by the Public Utility Commission of Texas.

### 1.7.3 Transmission Operator (TO)

Transmission Operators (TOs) are the subset of Transmission Service Providers (TSPs) or Transmission and/or Distribution Service Providers (TDSPs) that is charged with continuous communication (7x24 basis) with the ERCOT Control Area Authority (CAA) and carrying out Dispatch Instructions directly or on behalf of represented TDSPs. Each TSP or TDSP will designate either itself or another TSP or TDSP to perform the functions of a TO. TOs must meet all requirements identified in the ERCOT Protocols for TDSPs and TSPs in addition to those requirements stated below for all Transmission Facilities represented:

- Operate and manage the electric Transmission Facilities between energy sources and the point of delivery;

- Accomplish switching of transmission elements. Develop, maintain, and implement transmission switching policies and procedures to provide for transmission reliability;
- Coordinate emergency communications between the TDSP or TSP and ERCOT CAA;
- Monitor the loading of the transmission system(s);
- Notify the ERCOT CAA of changes to the status of all Transmission Facilities;
- Act as Single Point of Contact for Transmission Outages;
- Maintain operational metering; and,
- Implement Black Start.

Transmission Operators shall provide the ERCOT CAA their written backup control plans to continue operation in the event the Transmission Operator's control center becomes inoperable.

Each backup control plan shall be reviewed and updated annually and shall meet the following minimum requirements:

- Include description of actions to be taken by TO personnel to avoid placing a prolonged burden on ERCOT and other Market Participants.
- Include description of specific functions and responsibilities to be performed to continue operations from an alternate location.
- Includes procedures and responsibilities for maintaining basic voice communications capabilities with ERCOT.
- Includes procedures for backup control function testing and the training of personnel.

As an option, the backup plan may include arrangements made with another entity to provide the minimum backup control functions in the event the TO's primary functions are interrupted.

#### **1.7.4 Resource Entity**

Resource Entities include Power Generation Companies, Opt-in generation, NOIE generation, federal generation facilities and LSEs representing load being used as a resource.

Any Generation Resource that introduces energy into the ERCOT grid must be represented by a Resource Entity. The sale of the generation produced is negotiated bilaterally with other Market Participants (MPs) with the exception of energy produced as Ancillary Services. The schedule for the power sale is communicated to the QSE that represents the Generation Entity in the ERCOT Market System. The QSE will communicate an overall Balanced Schedule for the QSE, including the Generation Entity, to ERCOT.

PGCs that offer Regulation Service and Responsive Reserve Services must be directly connected to the QSE for the purpose of receiving a regulation signal in Real Time.

*REFERENCE: PROTOCOL SECTION 22, ATTACHMENT A, STANDARD FORM BLACK START AGREEMENT (IN PART)*

*...Section 8. Operation.*

*C. Delivery.*

- (1) ERCOT shall notify Participant, through its QSE, when the Black Start Resource must black start.*
- (2) If the ERCOT Transmission Grid at the Black Start Resource becomes deenergized and if Participant cannot communicate with either ERCOT or the TDSP serving the Black Start Resource, then Participant shall follow the procedures specified for the Black Start Resource under ERCOT's Black Start Plan in the Operating Guides, but Participant shall not commence delivering electric energy into the ERCOT System without specific instructions to do so from either ERCOT or the TDSP serving the Black Start Resource...*

**1.7.5 Load Serving Entities (LSE)**

LSEs include Non Opt-in Entities, the Texas General Land Office and Competitive Retailers. These are the only organizations authorized to sell electricity directly to retail customers. An LSE will forecast its contracted load and negotiate bilaterally with Resource Entities to obtain the forecasted energy. The schedule resulting from this negotiation will be communicated to the QSE, who in turn will communicate an overall Balanced Schedule for the QSE to ERCOT.



## 1.8 Operational Training

### 1.8.1 Operator Training Objectives

A primary objective of each Operating Entity within the ERCOT System shall be to train Operators such that they will possess the necessary skills and ability to direct the operation of the power system in accordance with the Protocols, these Operating Guides, ERCOT Control Area Operator Procedures as well as individual entity operating goals, plans and procedures.

These training objectives are:

- a. Maintain the safety of personnel, even during emergency situations involving complex switching and manipulation of control elements.
- b. Protect system components, particularly major power system elements from serious life degradation or harm.
- c. Operate the system in a secure manner to minimize violations of operating limits, avoiding customer outages where reasonably possible, and avoiding unstable situations that might result in widespread outages or blackouts.
- d. Operate the system as economically as possible within continually changing operating constraints.
- e. Restore the system to its normal operating state as rapidly as practical after a disturbance.

### 1.8.2 System Operator Training Requirements

The System Operator Training Program applies to all Control Area Authority and Transmission Operators who are responsible for the Real-Time operation or reliability monitoring of the bulk electric system and those Qualified Scheduling Entity (QSE) Operators who represent Generation Resources or Loads acting as Resources (LaaRs). At least thirty-two (32) hours per year of system emergency training and drills, appropriate to each class of operator, must be included in the training program. QSE Operators who do not represent Generation Resources or LaaRs must participate in at least eight (8) hours per year in system emergency training and drills.

For those operators required to obtain thirty-two (32) hours annually, at least eight (8) hours must be from simulations or realistic drills.

Participation in emergency simulations, Severe Weather Drills, ERCOT Black Start Training, and portions of the ERCOT Operations Training Seminar that relate to North American Electric Reliability Corporation (NERC) recommended topics can be used to satisfy this requirement. Task specific training carried out internally within an Entity will be considered in full compliance with this requirement. Training documentation, including curriculum, training methods, and individual training records, shall be available for verification during audits.

### **1.8.3 ERCOT Operations Training Seminar**

ERCOT will host a training seminar that, as a minimum, will be held annually. The purpose of the training seminar is to provide a forum for system wide problems to be effectively addressed and to maintain an operator training consistency across all ERCOT System Operating Entities.

The seminar provides a forum for all ERCOT System Entity Operators and ERCOT System Operators, to meet and analyze common topics and issues as well as participate in formal training sessions.

### **1.8.4 ERCOT Black Start Training**

ERCOT shall periodically conduct system restoration seminars for all Transmission and Distribution Service Providers, Qualified Scheduling Entities, Generation Entities and other Market Participants, in accordance with Protocol Section 6.5.8, Black Start Service.

### **1.8.5 ERCOT Severe Weather Drill**

ERCOT shall conduct a Severe Weather Drill one time a year. This drill will be used to test the scheduling and communication functions of the primary and/or back up centers and train operators in emergency procedures. All Qualified Scheduling Entities that provide Ancillary Services and Transmission Operators are required to participate in the drill. ERCOT will appoint an ERCOT Drill Coordinator who, with assistance from the Operations Working Group, will develop and coordinate the annual Severe Weather Drill. The Operations Working Group will review and critique the results of completed Severe Weather Drills to ensure effectiveness and recommend changes as necessary. ERCOT Compliance will verify and report Entity participation to the Reliability and Operations Subcommittee.

### **1.8.6 Criteria For The Selection Of Operators**

To be selected as Operators, candidates should be capable of directing other personnel in their own organization and, at the same time, work harmoniously with the ERCOT System Operators and other Entities' Operators. In addition, they must have a high intellectual ability, above average reasoning, mathematical ability, well-developed communication skills and reasonable mechanical aptitude. To ensure compliance with these criteria, a screening and selection procedure must be considered for prospective Operators. This procedure should include the following:

- a. Evaluation against a detailed job description.
- b. Analysis of the candidate's past work record to determine character, reputation, and previous experience.
- c. In-depth interview with each candidate.
- d. Evaluation of intelligence, logic, mathematical, and communication skills along with psychological fitness.

### **1.8.7 Training Practices**

Each Operating Entity should establish a clear requirement, define and develop a systematic approach in administering the training, and provide the necessary feedback as a measurement of curriculum suitability and trainee progress. Each Operating Entity should recognize the importance of training and provide sufficient Operator participation through adequate staffing and work-hour scheduling.

## 1.9 Document Revisions

### *Change History*

<b>ISSUE/DATE</b>	<b>REASON FOR ISSUE</b>
Version 1.0 February 28, 2001	Updated from Working Group comments. Submitted to Technical Advisory Committee to approve handover to the Reliability Operating Subcommittee
Version 1.1 April 10, 2001	Reference to Market Oversight Division corrected, added ROS responsibility for submitting PRR, minor formatting changes
May 1, 2002	Formatting
July 1, 2002	OGRR102
October 1, 2002	OGRR115
December 1, 2002	Corrected diagrams in Sections 1.2 & 1.4.
January 1, 2003	OGRR120 revised Section 1.7.3 to add a backup plan requirement for TOs.
March 1, 2003	Revised header to state "Section."
May 1, 2003	Revised diagrams on pages 3 & 5 to state "ERCOT Operating Guides" instead of System Operating Guide. Added language from OGRR128 to allow for administrative update of Protocols references included in the Operating Guides.
October 1, 2003	OGRR132
June 1, 2004	OGRR143
November 1, 2004	OGRR150, OGRR151 and corrected typographical errors in Protocol references
June 1, 2005	Admin OGRR168
November 4, 2005	OGRR175
June 1, 2006	OGRR182
December 1, 2006	OGRR186
February 1, 2007	Admin OGRR190
May 1, 2007	Admin OGRR195
September 1, 2007	OGRR202
May 1, 2008	OGRR205, Admin OGRR207
March 1, 2009	OGRR213
March 5, 2009	OGRR220
April 1, 2009	OGRR219
May 1, 2009	OGRR213 (unboxed due to effective date)
July 1, 2009	OGRR218

---

---

# ***ERCOT OPERATING GUIDES***

---

---

## **Section 2: System Operations**

---

---

### **ERCOT Control Area Authority Operation**

July 1, 2009

**PUBLIC**

# Contents

<b>2.</b>	<b>SYSTEM OPERATIONS .....</b>	<b>2-5</b>
2.1	OPERATIONAL DUTIES.....	2-5
2.2	SYSTEM MONITORING AND CONTROL .....	2-7
2.2.1	Overview.....	2-7
2.2.2	Security Criteria.....	2-8
2.2.3	Automatic Generation Control Systems .....	2-9
2.2.4	Automatic Voltage Regulators and Power System Stabilizers .....	2-11
2.2.5	Turbine Speed Governors.....	2-11
2.2.6	Performance/Disturbance/Compliance Analysis .....	2-12
2.2.7	Time Error and Time Synchronization.....	2-12
2.3	DISPATCH DUTIES .....	2-14
2.3.1	Control Area Operator Authority.....	2-14
2.3.2	Dispatch Instruction Procedures.....	2-15
2.4	SCHEDULING .....	2-18
2.4.1	Day Ahead Scheduling .....	2-18
2.4.2	Adjustment Period Scheduling Process.....	2-20
2.4.3	Direct Current Tie Interconnection Day Ahead Scheduling Process .....	2-21
2.4.4	Temporary Deviations from Scheduling Procedures .....	2-22
2.4.5	Real-Time Schedules .....	2-23
2.5	ANCILLARY SERVICES.....	2-30
2.5.1	ERCOT Responsibilities.....	2-30
2.5.2	Responsive Reserve .....	2-35
2.5.3	Non-Spinning Reserve Service (NSRS).....	2-38
2.5.4	Replacement Reserve Service (RPRS).....	2-39
2.5.5	Balancing Energy Service .....	2-40
2.6	CHANGES IN SYSTEM STATUS .....	2-43
2.6.1	Changes in Resource Status .....	2-43
2.6.2	Changes in Transmission Facility Status .....	2-43
2.7	OUTAGE COORDINATION.....	2-44
2.7.1	ERCOT Control Area Authority Responsibilities.....	2-44
2.7.2	Forced Outages .....	2-44
2.7.3	Scheduled Outages .....	2-45
2.8	CONGESTION MANAGEMENT.....	2-47
2.8.1	Overview of ERCOT Coordinated Congestion Management.....	2-47
2.9	REQUIREMENTS FOR UNDER-FREQUENCY RELAYING .....	2-49
2.9.1	Automatic Firm Load Shedding .....	2-49
2.9.2	Generators.....	2-50
2.10	SYSTEM VOLTAGE PROFILE.....	2-51
2.10.1	Introduction.....	2-51
2.10.2	Maintaining Voltage Profile.....	2-51
2.10.3	Special Consideration for Nuclear Power Plants .....	2-52
2.10.4	Reactive Considerations for Gas and Steam Turbine Power Plants.....	2-53
2.11	EXTERNAL CONTROL AREA INTER-TIES.....	2-54
2.11.1	Control Area Operations.....	2-54

2.11.2	<i>Operation of DC Ties</i> .....	2-54
2.12	DOCUMENT CONTROL.....	2-55

## Protocol References

REFERENCE: PROTOCOL SECTION 5.1.2, OPERATING GUIDES AND NORTH AMERICAN ELECTRIC RELIABILITY COUNCIL GUIDELINES.....	2-5
REFERENCE: PROTOCOL SECTION 5.3, ROUTINE DISPATCH DUTIES OF ERCOT (IN PART) .....	2-5
REFERENCE: PROTOCOL SECTIONS 6.1.2, REGULATION SERVICE – DOWN AND 6.1.3, REGULATION SERVICE – UP.....	2-10
REFERENCE: PROTOCOL SECTION 6.5.7.2, QSE RESPONSIBILITIES (IN PART).....	2-11
REFERENCE: PROTOCOL SECTION 5.2.2, OPERATING STANDARDS .....	2-14
REFERENCE: PROTOCOL SECTION 5.4.2.1, VERBAL DISPATCH INSTRUCTIONS.....	2-15
REFERENCE: PROTOCOL SECTION 5.4.2.2, DISPATCH INSTRUCTION VIA THE MESSAGING SYSTEM	2-16
REFERENCE: PROTOCOL SECTION 5.4.4, COMPLIANCE WITH DISPATCH INSTRUCTIONS.....	2-16
REFERENCE: PROTOCOL SECTION 4.2, SCHEDULING-RELATED DUTIES OF ERCOT .....	2-18
REFERENCE: PROTOCOL SECTION 4.4.2, POSTING OF FORECASTED ERCOT SYSTEM CONDITIONS	2-18
REFERENCE: PROTOCOL SECTION 4.4.4, NOTIFICATION TO QSEs OF ANCILLARY SERVICE OBLIGATIONS.....	2-19
REFERENCE: PROTOCOL SECTION 4.4.5, NOTIFICATION TO QSEs OF MANDATORY BALANCING ENERGY SERVICE DOWN BID PERCENTAGE REQUIREMENTS .....	2-19
REFERENCE: PROTOCOL SECTION 4.1.2, ADJUSTMENT PERIOD SCHEDULING PROCESS .....	2-20
REFERENCE: PROTOCOL SECTION 4.4.18.1, CONTROL AREA OPERATIONS .....	2-21
REFERENCE: PROTOCOL SECTION 4.4.18.2, LINKAGE OF SCHEDULES WITH INTERCONNECTED NON-ERCOT CONTROL AREA SCHEDULES .....	2-22
REFERENCE: PROTOCOL SECTION 4.4.18.3, OPERATION OF DC TIES .....	2-22
REFERENCE: PROTOCOL SECTION 4.8, TEMPORARY DEVIATIONS FROM SCHEDULING PROCEDURES .....	2-22
REFERENCE: PROTOCOL SECTION 4.9.1, DYNAMIC LOAD SCHEDULES .....	2-23
REFERENCE: PROTOCOL SECTION 4.9.2, APPROVAL OF THE USE OF DYNAMIC LOAD SCHEDULES	2-23
REFERENCE: PROTOCOL SECTION 4.9.3, PRINCIPLES FOR DYNAMIC SCHEDULES .....	2-24
REFERENCE: PROTOCOL SECTION 4.9.4.1, APPROVAL OF THE USE OF RESPONSIBILITY TRANSFERS .....	2-24
REFERENCE: PROTOCOL SECTION 4.9.4.2, PRINCIPLES FOR RESPONSIBILITY TRANSFERS .....	2-25
REFERENCE: PROTOCOL SECTION 6.5.9, RELIABILITY MUST RUN SERVICE.....	2-26
REFERENCE: PROTOCOL SECTION 6.7.8, DEPLOYMENT OF RMR SERVICE.....	2-28
REFERENCE: PROTOCOL SECTION 6.3.1, ERCOT RESPONSIBILITIES .....	2-30
LANGUAGE EXTRACTED FROM PROTOCOL SECTION 6.1, ANCILLARY SERVICES REQUIRED BY ERCOT (IN MODIFIED FORM) .....	2-32
THE TYPES OF ANCILLARY SERVICES REQUIRED BY ERCOT ARE DESCRIBED BELOW. ....	2-32
REFERENCE: PROTOCOL SECTION 6.5.4, RESPONSIVE RESERVE SERVICE (IN PART).....	2-35
REFERENCE: PROTOCOL SECTION 6.5.4, RESPONSIVE RESERVE SERVICE (IN PART).....	2-36
REFERENCE: PROTOCOL SECTION 6.5.5, NON-SPINNING RESERVE SERVICE (NSRS) (IN PART)	2-38
REFERENCE: PROTOCOL SECTION 6.5.5, NON-SPINNING RESERVE SERVICE (NSRS) (IN PART)	2-38
REFERENCE: PROTOCOL SECTION 6.5.6, REPLACEMENT RESERVE SERVICE (IN PART).....	2-39
REFERENCE: PROTOCOL SECTION 6.5.2, BALANCING ENERGY SERVICE (IN PART) .....	2-40
ERCOT OPERATING GUIDES – JULY 1, 2009	2-3

REFERENCE: PROTOCOL SECTION 6.10.3, ANCILLARY SERVICES QUALIFICATION AND PORTFOLIO TEST METHODS (IN PART)..... 2-41

REFERENCE: PROTOCOL SECTION 6.10.3.4, BALANCING ENERGY (IN PART) ..... 2-41

REFERENCE: PROTOCOL SECTION 5.5.1, CHANGES IN RESOURCE STATUS (IN PART) ..... 2-43

REFERENCE: PROTOCOL SECTION 5.5.2, CHANGES IN TRANSMISSION FACILITY STATUS ..... 2-43

REFERENCE: PROTOCOL SECTION 7.1, OVERVIEW OF ERCOT CONGESTION MANAGEMENT ..... 2-47

REFERENCE: PROTOCOL SECTION 6.5.7.2, QSE RESPONSIBILITIES (IN PART) ..... 2-53

REFERENCE: PROTOCOL SECTION 6.10.9, REACTIVE POWER SUPPLY FROM GENERATION RESOURCES REQUIRED TO PROVIDE VSS PERFORMANCE CRITERIA (IN PART)..... 2-53

REFERENCE: PROTOCOL SECTION 4.4.18.5, INADVERTENT ENERGY ACCOUNT..... 2-54



## 2. System Operations

### 2.1 Operational Duties

**REFERENCE:** Protocol Section 5.1.2, Operating Guides and North American Electric Reliability Council Guidelines

*ERCOT will perform all control area functions as defined in the Operating Guides and the North American Electric Reliability Corporation (NERC) guidelines.*

**REFERENCE:** Protocol Section 5.3, Routine Dispatch Duties of ERCOT (In Part)

*...ERCOT is the regional security coordinator for the ERCOT Region and is responsible for all regional security coordination as defined in the NERC Operating Manual and applicable ERCOT operating manuals or Operating Guides...*

The duties of the ERCOT Control Area Authority are described in relevant sections of the Protocols. The following lists the primary operational duties to be performed by the ERCOT Control Area Authority. Each of these duties as well as all other ERCOT responsibilities are to be executed in accordance with the applicable Protocols. The ERCOT Protocols shall control the extent of any inconsistency between the Protocols and any of the following Operating Guides.

<b>CONTROL AREA AUTHORITY RESPONSIBILITY</b>	<b>CONTROL AREA AUTHORITY ACTION</b>
Ensure the reliability of the ERCOT Transmission Grid in accordance with North American Electric Reliability Corporation (NERC)/ERCOT reliability guidelines.	<ul style="list-style-type: none"> <li>➤ Evaluate ERCOT Transmission Grid conditions on a continuous basis.</li> <li>➤ Oversee operation of the ERCOT Transmission Grid and act as the ERCOT Control Area Authority.</li> <li>➤ Serve as the point of contact for initiation of generation interconnection to the transmission system.</li> <li>➤ Implement Congestion management of the ERCOT Transmission Grid on a nondiscriminatory basis.</li> <li>➤ Coordinate all Planned Outages of transmission system Facilities.</li> <li>➤ Schedule ERCOT Interchange transactions across the Direct Current (DC) Ties.</li> <li>➤ Deploy Ancillary Services.</li> <li>➤ Compile a detailed operations plan to ensure that sufficient resources and required Ancillary Services have been provided for all expected Load and transactions within the ERCOT Region.</li> <li>➤ Forecast the actual Load, generation dispatch and</li> </ul>

<b>CONTROL AREA AUTHORITY RESPONSIBILITY</b>	<b>CONTROL AREA AUTHORITY ACTION</b>
	<p>transmission system operations for the next seven days and update Total Transmission Capacity, as necessary.</p> <ul style="list-style-type: none"> <li>➤ Adjust resources in accordance with the ERCOT Protocols as needed to maintain ERCOT in a secure operating condition and meet NERC frequency control performance requirements.</li> </ul>
Supervise the ERCOT System operational transmission planning	<ul style="list-style-type: none"> <li>➤ Perform operational transmission system security studies, including those related to generation and Load interconnection responsibilities.</li> <li>➤ Review outages of generating units and major transmission lines to identify constraints that may affect transfers.</li> <li>➤ Perform Load flows and security analyses of Planned Outages submitted by Transmission and/or Distribution Service Providers (TDSPs) as a basis for approval or rejection.</li> <li>➤ Withdraw approval of a scheduled Transmission Facility Maintenance Outage if unable to meet the applicable reliability standards after all other reasonable options are exercised.</li> </ul>
Collect and disseminate information	<ul style="list-style-type: none"> <li>➤ Provide appropriate operational information to individual Qualified Scheduling Entities (QSEs) and Transmission Operators (TOs).</li> <li>➤ Provide relevant operational information to Market Participants (MPs) over the ERCOT Market Information System (MIS).</li> <li>➤ Collect and maintain Control Area Authority operational data required by the Public Utility Commission of Texas (PUCT) and the NERC.</li> <li>➤ Receive reports from TOs and QSEs and forward them to Department of Energy (DOE) and/or NERC as required.</li> <li>➤ Submit Reliability Coordinator reports to DOE and/or NERC as required.</li> <li>➤ Record and report accumulated time error.</li> </ul>

## 2.2 System Monitoring and Control

### 2.2.1 Overview

The Control Area Authority will maintain continuous surveillance of the status of operating conditions within the ERCOT System and act as a system security central information collection and dissemination point for Market Participants.

The Control Area Authority is the designated coordinating authority to request and receive information required to continually monitor the operating conditions of ERCOT and to order individual Qualified Scheduling Entities (QSEs) and/or Transmission Operators (TOs) make changes to assure ongoing security and reliability of the total ERCOT System.

The Control Area Authority shall maintain, monitor or direct the following in accordance with the ERCOT Protocols:

<b>CONTROL AREA AUTHORITY RESPONSIBILITY</b>	<b>CONTROL AREA AUTHORITY ACTION</b>
Generation	<ul style="list-style-type: none"> <li>➤ Monitor unit status and capability,</li> <li>➤ Monitor Automatic Voltage Regulator (AVR) status,</li> <li>➤ Monitor unit commitment,</li> <li>➤ Balance system generation and Loads,</li> <li>➤ Monitor operating reserves,</li> <li>➤ Monitor Forced Outages and capability limitations,</li> <li>➤ Maintain net capability test results,</li> <li>➤ Maintain Loads acting as Resources (LaaRs) test results,</li> <li>➤ Compile Ancillary Services Plans,</li> <li>➤ Perform Ancillary Services deployment,</li> <li>➤ Collect data for Ancillary Services accounting,</li> <li>➤ Monitor maintenance schedules, and</li> <li>➤ Monitor power system stabilizer status.</li> </ul>
Bulk-Power Transmission System	<ul style="list-style-type: none"> <li>➤ Monitor line loading and power transfers,</li> <li>➤ Coordinate Planned Outages,</li> <li>➤ Monitor and detect Forced Outages,</li> <li>➤ Perform contingency analyses,</li> <li>➤ Maintain maintenance and construction schedules,</li> <li>➤ Monitor and control voltage levels, and</li> <li>➤ Monitor Reactive Power flows.</li> </ul>

<b>CONTROL AREA AUTHORITY RESPONSIBILITY</b>	<b>CONTROL AREA AUTHORITY ACTION</b>
System Operation	<ul style="list-style-type: none"> <li>➤ Monitor power transfers and interchange,</li> <li>➤ Maintain and monitor Ancillary Services Plans and delivery,</li> <li>➤ Maintain compliance with transmission security criteria,</li> <li>➤ Monitor QSE providers of Regulation Service (RGS),</li> <li>➤ Manage Inadvertent Energy Account balances,</li> <li>➤ Direct Time Error Correction,</li> <li>➤ Issue and direct Operating Condition Notices (OCNs), Advisories, Watches and Emergency Notices,</li> <li>➤ Direct short supply operations,</li> <li>➤ Direct implementation of the Energy Emergency Alert (EEA), and</li> <li>➤ Direct coordination of the Black Start Plan.</li> </ul>
Reporting	<ul style="list-style-type: none"> <li>➤ Monitor and coordinate information for daily planning, hourly reporting and minute-by-minute operation.</li> <li>➤ Verify the accuracy of the Real Time data.</li> <li>➤ Operate a Market Information System (MIS) and a Power Operating System (POS) to disseminate Real Time, hourly accounting, and operations plan data to and from the Control Area Authority and each QSE and TO control center.</li> <li>➤ Establish the procedure for each TO and QSE to report to the Control Area Authority.</li> </ul>

### 2.2.2 Security Criteria

Technical limits established for the operation of transmission equipment shall be applied consistently in Total Transfer Capability (TTC) calculations, Engineering Studies, Real Time security analyses, and operator actions.

Unless an Emergency Condition has been declared by ERCOT, the ERCOT System shall be operated in such a manner that the occurrence of a single contingency will not cause any of the following conditions:

- a. Uncontrolled breakup of the transmission system;
- b. Loading of Transmission Facilities above defined emergency ratings which cannot be eliminated in time to prevent damage or failure following the loss through execution of specific, predefined operating procedures;

- c. Transmission voltage levels outside system design limits which cannot be corrected through execution of specific, predefined operating procedures before voltage instability or collapse occurs; or
- d. Customer outages, except for high set interruptible and radially served loads.

A credible single contingency is defined as the Forced Outage of two (2) generating units as defined in item (2) of Section 5.1.4, Transmission Reliability Testing, in the ERCOT System within a short period of time, or the Forced Outage of any single transmission element (such as a circuit or transformer). The Forced Outage of a double-circuit transmission line (DCKT) will be considered a credible single contingency during any ERCOT declared Watch or for any operating conditions characterized by high DCKT Outage probability or consequence.

### **2.2.3 Automatic Generation Control Systems**

ERCOT shall operate the frequency control system to maintain the scheduled frequency at 60 Hz (correcting periodically for time error) and to minimize the use of energy from Resources providing Regulation Service.

The ERCOT frequency control system shall deploy Regulation and Responsive Reserve energy as necessary in accordance with the ERCOT Protocols to meet NERC requirements.

ERCOT will deploy resources via electronic instruction to QSEs that represent generators providing Automatic Generation Control (AGC) resources. QSEs shall use AGC to direct the output of generation facilities within the response times described in the ERCOT Protocols and Operating Guide Section 8, Operational Metering and Communication.

#### **2.2.3.1 Bias Settings**

In the Schedule Control Error equation, QSEs shall have bias settings that approximate the measured frequency response characteristic of their On-line Resources. This bias setting should be changed when significant On-line generating capability changes or when their Resources' frequency response characteristics change. The ERCOT Control Area Authority will check the area frequency response characteristic each time a disturbance qualifies as a measurable event per Protocol Section 5.9.2, Primary Frequency Control Measurements. Information thus obtained will be used to evaluate ERCOT and QSE bias settings.

#### **2.2.3.2 Maintenance and Verification**

Each provider of Regulation and/or Responsive Reserve ancillary service will properly maintain Automatic Generation Control equipment.

The ERCOT Control Area Authority will initiate a regulation survey to evaluate the performance of all Automatic Generation Control equipment in ERCOT.

#### **2.2.3.3 Regulation Provider Loss of AGC (Generator loses pulse signal)**

If a QSE providing Regulation Services or Responsive Reserve Services loses its Automatic Generation Control for any reason, it will notify the ERCOT Control Area Authority as soon as practicable of the reason for and estimated duration of the loss. The ERCOT Control Area Authority will assess whether additional action should be taken to maintain ERCOT System frequency. Possible ERCOT actions include:

- Placing another QSE on Flat Frequency Control, and/or
- Opening the market for new Regulation or Responsive Reserve resource bids for the period of anticipated loss.

#### 2.2.3.4 ERCOT Control Area Authority Loss of Automatic Control

The ERCOT Control Area Authority is obligated to have back-up facilities in place for loss of control systems. In the event that these backup facilities also fail to perform, the ERCOT Control Area Authority shall direct specific QSEs providing frequency control to implement Flat Frequency Control.

If action is necessary, the ERCOT Control Area Authority will arrange for these QSEs to go on Flat Frequency Control (FFC) for the duration of the control loss and will define the ERCOT bias. If a QSE on FFC develops a problem with regulating room, the ERCOT Control Area Authority will order additional balancing or regulation energy from another QSE to create regulation room.

#### 2.2.3.5 Changes in Control Mode

A QSE shall notify (telephone) the ERCOT Control Area Authority and obtain approval prior to changing control modes. Valid QSE control modes are Normal (Ancillary Services control), Flat Frequency and Off control.

#### 2.2.3.6 Load and Frequency Regulation

**REFERENCE:** Protocol Sections 6.1.2, Regulation Service – Down and 6.1.3, Regulation Service – Up

##### 6.1.2 Regulation Service – Down

**As provided by ERCOT to the QSEs:** Regulation-down power is deployed in response to an increase in ERCOT System frequency to maintain the target ERCOT System frequency within predetermined limits according to the Operating Guides.

**As provided by a QSE to ERCOT:** The provision of Resource capacity to ERCOT so that ERCOT can deploy power for the purpose of controlling frequency by continuously balancing generation and Load within the ERCOT System.

##### 6.1.3 Regulation Service-Up

**As provided by ERCOT to the QSEs:** Regulation up power is deployed in response to a decrease in ERCOT System frequency to maintain the target ERCOT System frequency within predetermined limits according to the Operating Guides.

**As provided by a QSE to ERCOT:** The provision of Resource capacity to ERCOT so that ERCOT can deploy power for the purpose of controlling frequency by continuously balancing generation and Load within the ERCOT System.

The ERCOT Control Area Authority shall purchase sufficient Regulation resources to provide satisfactory control performance for ERCOT. ERCOT shall determine the satisfactory amount of Regulation Service required by statistical analysis of possible unit

outages and load forecast error to expect operation 95% of hours without deploying Responsive Reserve Service.

#### 2.2.4 Automatic Voltage Regulators and Power System Stabilizers

**REFERENCE:** Protocol Section 6.5.7.2, QSE Responsibilities (In Part)

...(4) *Each QSE's Generation Resource providing VSS shall operate with the unit's Automatic Voltage Regulator (AVR) set to regulate generator terminal voltage in the voltage control mode unless specifically directed to operate in manual mode by ERCOT, or when the unit is going On- or Off- line. If the QSE changes the mode, other than under ERCOT direction, then the QSE shall promptly inform ERCOT. Any QSE-controlled power system stabilizers will be kept in service unless specifically permitted to operate otherwise by ERCOT. QSEs' control centers will monitor the status of their regulators and stabilizers, and shall report abnormal status changes to ERCOT...*

Generator Automatic Voltage Regulators (AVR) and power system stabilizers (PSS) will be kept in service whenever possible. Generation Resources (GR) shall notify their Qualified Scheduling Entity (QSE) who in turn will promptly notify the ERCOT Control Area Authority when a voltage regulator or stabilizer is taken out of service due to equipment maintenance or failure and when it is returned to normal operation. ERCOT is responsible for notifying the appropriate TO of such AVR and PSS status changes. QSEs shall supply AVR and PSS status logs to ERCOT upon request.

Performance tests shall be conducted on Automatic Voltage Regulators every five years or if equipment characteristics are knowingly modified. The test reports should include the minimum and maximum excitation limiters, volts/hertz settings, gain and time constants, type of voltage regulator control function, date tested, and voltage regulator control setting.

Excitation systems, including power system stabilizers, shall also be tested every five (5) years.

#### 2.2.5 Turbine Speed Governors

A governor shall be in-service when the turbine's generator is synchronized to the grid.

Power Generation Companies (PGCs) shall conduct governor performance tests at least every two years using the one of the methods specified in Section 6.2.1.5, Combustion Turbine Frequency Response Test Procedure or 6.2.1.6, Combustion Turbine Frequency Response Procedures Based on Historical Data, located in these Operating Guides. The PGC's reporting QSE shall provide test results to ERCOT.

Every effort should be made to maintain governors droop characteristic not to exceed 5%.

There are elements that can contribute to poor governor response. These include:

- Excessive Governor dead band. Maximum intentional dead band: +/- 0.036 Hz.
- Valve position limits
- Blocked governor operation
- Control mode
- Adjustable rates or limits

- Boiler/turbine coordinated control or set point control action
- Automated “reset” or similar control action of the turbine’s MW set point.

Every attempt should be made to minimize the effects of these and similar elements on the governor operation for the duration of all frequency deviations. Each QSE should monitor its units to verify that these elements do not contribute to a governor droop characteristic greater than five percent (5%).

### **2.2.6 Performance/Disturbance/Compliance Analysis**

Performance/Disturbance/Compliance analysis shall be performed by the ERCOT Control Area Authority for the purpose of ensuring conformance to published control criteria of ERCOT.

The Control Area Authority shall make a regular report on selected system disturbances, documenting the response of individual Qualified Scheduling Entities together with an ERCOT summary. In addition, Power Generation Companies, Qualified Scheduling Entities and individual members of the ERCOT Performance Disturbance Compliance Working Group (PDCWG) are encouraged to work within their respective companies to enhance the performance of individual generating units and control systems through application of the results of the Working Group studies.

ERCOT Compliance communicates with the Market Participants as appropriate to ensure compliance and improve performance.

As necessary, a Contingency Reserve Adjustment (CRA) will be calculated by the PDCWG and submitted to the Reliability and Operations Subcommittee for review and approval. ERCOT will include the CRA in the daily Ancillary Service plan.

### **2.2.7 Time Error and Time Synchronization**

#### **2.2.7.1 Time Error**

Sustained frequency deviations from scheduled frequency result in time error. Time error will be monitored and controlled in ERCOT as follows:

#### ***Time Error Monitoring***

ERCOT will monitor accumulated time error and initiate time corrections. The instantaneous time error is available to all ERCOT QSEs in the Market Information System (MIS). When time error is equal to or greater than  $\pm 3$  seconds, ERCOT may initiate a time correction. The correction will be terminated when the error is less than  $\pm 0.5$  seconds. The time correction may be postponed if it is determined that load patterns in the immediate future will result in the desired time correction; however, at no time should the accumulated time error be allowed to exceed five (5) seconds.

#### ***Time Error Correction***

When a time correction is necessary, ERCOT will adjust scheduled frequency in the following manner. ERCOT shall adjust generation to achieve the correction frequency (59.98 Hz for fast and 60.02 Hz for slow) and shall immediately notify all QSEs of the



frequency, start time, and end time. A time correction may be terminated after five hours or after any hour without a one-half second error reduction.

#### **2.2.7.2 Time Synchronization**

In order to promote accurate data reporting during EEA and other system events, and to ensure transaction schedules are simultaneous, all QSEs and TOs, and the ERCOT Control Area Authority will maintain their control system time within +/- three (3) seconds of the National Bureau of Standards (NBS) time signal. The NBS time signal shall set the time standard for ERCOT. The ERCOT Control Area Authority, QSEs deploying Ancillary Services and TOs will follow written procedures to compare and reset their clocks and voice and data recording systems' times with the NBS on at least a weekly basis.

## 2.3 Dispatch Duties

### 2.3.1 Control Area Operator Authority

ERCOT, as Control Area Operator (CAO), is authorized to take the following actions for the limited purpose of securely operating the ERCOT Transmission Grid in conformance with the standards specified in the Protocol Section 5.2, North American Electric Reliability Corporation/ERCOT Tagging Procedures, and according to the ERCOT Protocols in general. Standards and practices used in the operation of the ERCOT Transmission Grid include but are not limited to:

- Direct the physical operation of the ERCOT System, including circuit breakers, switches, voltage control equipment, protective relays, metering and Load shedding equipment;
- Deploy Resources that have committed to provide Ancillary Services;
- Direct changes in the operation of voltage control equipment;
- Direct the implementation of OOM obligations and the use of RMR Service and transmission switching in order to prevent the violation of ERCOT System security limits; and
- Take those additional actions required to prevent an imminent Emergency Condition or to restore the ERCOT System to a secure state in the event of an ERCOT System emergency.

**REFERENCE:** Protocol Section 5.2.2, Operating Standards

*ERCOT and TDSPs shall operate the ERCOT System in compliance with Good Utility Practice and NERC and ERCOT standards, policies, guidelines and operating procedures. These Protocols shall control to the extent of any inconsistency between the Protocols and any of the following documents:*

- (1) *Any reliability guides applicable to ERCOT, including the Operating Guides;*
- (2) *The NERC Operating Manual and ERCOT procedures manual, supplied by NERC and ERCOT, respectively, as references for dispatchers to use during normal and emergency operations of the ERCOT Transmission Grid;*
- (3) *Specific operating procedures, submitted to ERCOT by individual transmission Facility owners or operators to address operating problems on their respective grids that could affect operation of the interconnected ERCOT Transmission Grid; and*
- (4) *Guidelines established by the ERCOT Board, which may be more stringent than those established by NERC for the secure operation of the ERCOT System.*

### 2.3.2 Dispatch Instruction Procedures

Dispatch Instructions consist of verbal Dispatch Instructions and Dispatch Instructions issued via the Messaging System. The procedures for all Dispatch Instructions are as follows:

TYPE OF INSTRUCTION	ERCOT CONTROL AREA AUTHORITY PROCEDURE
All Dispatch Instructions to Resources (whether for Dispatch of Ancillary Services, system emergencies or any other reason)	Directed to the Qualified Scheduling Entity (QSE) responsible for the affected Resource, normally performed electronically via Remote Terminal Unit (RTU), Inter-Control Center Communications Protocol (ICCP) or Extensible Markup Language (XML)
Resource or group of Resources has inadequately responded to a Dispatch Instruction	Notify the relevant QSE
Verbal communication of Dispatch Instructions	Record all voice conversations that occur
Written or electronic communication of Dispatch Instructions	Record or file all written or electronic Dispatch Instructions and acknowledgements as soon as practicable after the issuance of the Dispatch Instruction
Recipient of Dispatch Instruction, by mutual agreement of the QSE and ERCOT or the Transmission and/or Distribution Service Provider (TDSP) and ERCOT	Dispatch Instructions to the QSE or TDSP may be provided to the QSEs or TDSPs or their Designated Agent

#### 2.3.2.1 Contents of Verbal Dispatch Instructions

**REFERENCE:** Protocol Section 5.4.2.1, Verbal Dispatch Instructions

*Valid verbal Dispatch Instructions shall contain the following information:*

- (1) *Identification of the responsible Entity and instructing authority (to include ERCOT operator's and receiving operator's names);*
- (2) *Specific Resources or TDSP Facilities that are the subject of the Dispatch Instruction;*
- (3) *Specific action required;*
- (4) *Current operating level or state of the Resources or TDSP Facilities that are the subject of the Dispatch Instruction;*

- (5) *Operating level or state to which such Resources or Facilities will be dispatched;*
- (6) *Time of notification of the Dispatch Instruction;*
- (7) *Time at which the QSE or TDSP is required to initiate the Dispatch Instruction;*
- (8) *Time within which the QSE or TDSP is required to complete the Dispatch Instruction; and*
- (9) *Other information relevant to the specific Dispatch Instruction.*

### **2.3.2.2 Dispatch Instruction via the Messaging System**

**REFERENCE:** Protocol Section 5.4.2.2, Dispatch Instruction via the Messaging System

*Valid Dispatch Instructions issued via the messaging system shall contain the following information:*

- (1) *Identification of the responsible Entity;*
- (2) *Specific Resources that are the subject of the Dispatch Instruction;*
- (3) *Specific action required;*
- (4) *Time of notification of the Dispatch Instruction via a timestamp on the Dispatch Instruction;*
- (5) *Time at which the QSE is required to initiate the Dispatch Instruction;*
- (6) *Time within which the QSE is required to complete the Dispatch Instruction; and*
- (7) *Other information relevant to the specific Dispatch Instruction.*

### **2.3.2.3 Compliance with Dispatch Instructions**

**REFERENCE:** Protocol Section 5.4.4, Compliance with Dispatch Instructions

- (1) *Each TDSP and each QSE within the ERCOT System shall comply fully and promptly with valid Dispatch Instructions, unless in the sole and reasonable judgment of the TDSP or QSE, such compliance would create a threat to safety, risk of bodily harm or damage to the equipment, or is otherwise not in compliance with these Protocols.*
- (2) *If the recipient of a valid Dispatch Instruction does not comply because in the sole and reasonable judgment of the TDSP or QSE, such compliance would create a threat to safety, risk of bodily harm or damage to the equipment, or is otherwise not in compliance with these Protocols, then, the TDSP or QSE must immediately notify ERCOT and provide the reason for non-compliance.*
- (3) *If the recipient of a Dispatch Instruction recognizes that the Dispatch Instruction conflicts with other valid instructions or is invalid, the recipient will immediately notify ERCOT of the conflict and request resolution.*
- (4) *Upon receipt of notice of non-compliance or conflict with Dispatch Instructions, ERCOT may, but is not required to, issue new Dispatch Instructions in response to the TDSP or QSE's notice.*
- (5) *ERCOT's final instruction in effect will apply for all Protocol-related processes. If the QSE does not comply after receiving the final instruction, the QSE shall remain liable for failure to*

*meet its obligations under the Protocols and shall remain liable for any charges resulting from such failure.*

- (6) *ERCOT's final instruction to a TDSP in effect will apply for all Protocol-related processes. If the TDSP does not comply after receiving the final instruction, the TDSP shall remain liable for such failure under these Protocols in accordance with the TDSP's Agreement with ERCOT.*
- (7) *In all cases in which compliance with a Dispatch Instruction is disputed, both ERCOT and the QSE or TDSP shall document their communications, agreements, disagreements, and reasons for their actions, to enable resolution of the dispute through the ADR process in Section 20, Alternative Dispute Resolution.*

## 2.4 Scheduling

**REFERENCE:** Protocol Section 4.2, Scheduling-Related Duties of ERCOT

*ERCOT is responsible for administering the Day Ahead and Adjustment Period Scheduling Processes through which final schedules for energy and Ancillary Services are submitted by QSEs and a Current Operating Plan is developed for use in operating the ERCOT System in Real Time. To fulfill its responsibilities with respect to providing information to the market necessary for QSEs to schedule energy and Ancillary Services, ERCOT shall:*

- (1) *Post forecasted ERCOT System conditions and Load for the next seven (7) days, by hour, by Congestion Zone; ERCOT will also post any area Load forecasts that were used to create the system Load forecast;*
- (2) *Post forecasted Transmission Loss Factors and Distribution Loss Factors;*
- (3) *Post Load Profiles for non-IDR metered Customers;*
- (4) *Validate the QSEs' energy schedules and make adjustments as necessary in accordance with the validation process;*
- (5) *Validate the QSEs' Ancillary Service schedules and Self-Arranged Ancillary Service Resources;*
- (6) *Only accept schedules from a QSE; and*
- (7) *Require all Loads and Resources be represented by a QSE.*

### 2.4.1 Day Ahead Scheduling

The Control Area Authority is required to perform specific analysis of the ERCOT System and provide information to QSEs and others within the ERCOT System during specific periods of the day prior to the Operating Day, as follows:

<b>TIME PERIOD</b>	<b>ERCOT ACTION</b>
Prior to 0600	<p>For each hour of the Operating Day, ERCOT shall post:</p> <p><b>REFERENCE:</b> Protocol Section 4.4.2, Posting of Forecasted ERCOT System Conditions</p> <p><i>No later than 0600 in the Day Ahead ERCOT shall post the following information for each hour of the Operating Day:</i></p> <ol style="list-style-type: none"> <li>(1) <i>A forecast of conditions on the ERCOT System, including known transmission line and other Transmission Facility Outages;</i></li> <li>(2) <i>A forecast of Total Transfer Capability including any relevant information describing forecasted transfers for each CSC.</i></li> <li>(3) <i>Weather assumptions used by ERCOT to forecast ERCOT System conditions.</i></li> </ol>

TIME PERIOD	ERCOT ACTION
0600	<p>Publish updated transmission system information:</p> <p><b>REFERENCE:</b> Protocol Section 4.4.4, Notification to QSEs of Ancillary Service Obligations</p> <p><i>ERCOT will notify QSEs by 0600 of the Day Ahead of the QSE's Day Ahead Ancillary Service Obligations. The Day Ahead Ancillary Service Obligation will be assigned to each QSE by multiplying the ERCOT Obligation by the sum of the Load Ratio Shares, rounded to no fewer than six (6) decimal places, for the LSEs that a QSE represents.</i></p> <p><b>REFERENCE: PROTOCOL SECTION 4.4.5, NOTIFICATION TO QSEs OF MANDATORY BALANCING ENERGY SERVICE DOWN BID PERCENTAGE REQUIREMENTS</b></p> <p><i>ERCOT will make available via a programmatic interface and post by 0600 of the Day Ahead the percentage of mandatory Balancing Energy Service Down bids required by Congestion Zone for each hour of the Operating Day for each QSE. If ERCOT changes the percentage requirement for any hour for any Congestion Zone from the previous Operating Day, only then will ERCOT notify all QSEs by 0600 of the Day Ahead of the QSE's percentage requirement for Balancing Energy Service Down bids by Congestion Zone for each hour of the Operating Day. The percentage of mandatory Balancing Energy Service Down bids required will be the same for all QSEs, but will not apply to energy scheduled by ERCOT from Resources under an RMR Agreement.</i></p>
1100	<p>Validate Schedules and notify affected Qualified Scheduling Entities (QSEs) of any invalid or mismatched schedules.</p>
1115	<ul style="list-style-type: none"> <li>➤ Review Schedules using the Commercial Model</li> <li>➤ Evaluate CSC Congestion</li> <li>➤ Notify QSEs of Congested CSCs</li> <li>➤ Post schedule impact on CSCs</li> <li>➤ Notify QSEs of any difference in ERCOT's zonal Load forecast and the aggregate of QSE schedules in a zone.</li> </ul>
1300	<p>Validate Schedules and notify affected QSEs of any invalid or mismatched schedules</p>
1315	<p>Validate resubmitted schedules and adjust as necessary.</p>
1330	<ul style="list-style-type: none"> <li>➤ Purchase AS through ERCOT AS Market in order to complete ERCOT's Day Ahead AS plan.</li> </ul>

TIME PERIOD	ERCOT ACTION
	<ul style="list-style-type: none"> <li>➤ Review Day Ahead Market Clearing Prices for Capacity (MCPC) for each Day Ahead AS market operated by ERCOT.</li> </ul>
1500	Review and validate AS schedules as necessary.
1600	Verify that Resource Plans are sufficient to meet the QSE schedule. If not, ERCOT will notify the QSE.
No later than 1800	<ul style="list-style-type: none"> <li>➤ Evaluate Resource Plans to determine system security</li> <li>➤ Evaluate RPRS needed to correct CSC, and Operational Congestion – Operational Model, and capacity insufficiency.</li> <li>➤ Create Merit Order of RPRS by Zone or operational constraint as applicable</li> <li>➤ Determine MCPC for RPRS by Zone as applicable and save RPRS energy bids for applicable balancing markets.</li> <li>➤ Close and clear Day Ahead RPRS market</li> </ul>

#### 2.4.2 Adjustment Period Scheduling Process

**REFERENCE:** Protocol Section 4.1.2, Adjustment Period Scheduling Process

*The Adjustment Period (AP) Scheduling Process will follow the following timeline with time T being the start of the Operating Hour:*

<b>Adjustment Period</b>	<b>QSE Responsibility:</b>	<b>ERCOT Responsibility:</b>
<i>Time = T minus 60 minutes</i>	<ul style="list-style-type: none"> <li>• <i>Submit updated Balanced Schedule of Obligations and Supply for the hour beginning at Time T, and any hour after T.</i></li> <li>• <i>Submit bids for Balancing Energy including any mandatory decremental Balancing Energy bids and any mandatory Balancing Energy bids for Non-Spin obligations.</i></li> <li>• <i>Submit updated Self-Arranged AS schedule for the hour beginning at Time T and any hour after Time T (the amount of Self-Arranged AS may not change from Day Ahead, however, the Resources supplying the Self-Arranged AS may be altered. If ERCOT calls on additional AS in the AP, the allocated portion of the additional AS may be</i></li> </ul>	<ul style="list-style-type: none"> <li>• <i>Review updated Balanced Schedule.</i></li> <li>• <i>Review updated Resource Plans.</i></li> <li>• <i>Review updated Self-Arranged AS schedule.</i></li> <li>• <i>Validate schedules and notify affected QSEs of any invalid or mismatched schedules.</i></li> <li>• <i>Identify CSC Congestion or OC or capacity insufficiency.</i></li> </ul>



	<p><i>self-arranged).</i></p> <ul style="list-style-type: none"> <li>• <i>Submit updates to Resource Plan.</i></li> <li>• <i>Submit bids for RPRS.</i></li> <li>• <i>Submit bids for additional Ancillary Services.</i></li> <li>• <i>Submit bids for incremental and decremental Resource specific premiums.</i></li> </ul>	
<i>Time = T minus 45 minutes</i>	<ul style="list-style-type: none"> <li>• <i>Resubmit corrected schedules.</i></li> </ul>	

Any hour, on the hour, more than sixty (60) minutes prior to the Operating Hour, ERCOT Control Area Authority shall perform the following actions, based on QSE submissions:

- Review QSE submitted updated Balanced Schedules;
- Review QSE submitted updated Resource Plans;
- Review QSE submitted updated Self-Arranged Ancillary Service schedule;
- Validate schedules and notify affected QSEs of any invalid or mismatched schedules;
- Identify CSC or OC Congestion or capacity insufficiency and take action to maintain ERCOT security;
- Any hour, fifteen (15) minutes after the hour, more than sixty (60) minutes prior to the Operating Hour, ERCOT will validate resubmitted schedules and adjust as necessary.

### **2.4.3 Direct Current Tie Interconnection Day Ahead Scheduling Process**

#### **2.4.3.1 Control Area Operations**

**REFERENCE:** Protocol Section 4.4.18.1, Control Area Operations

*Control Area schedules between the ERCOT Control Area and interconnected non-ERCOT Control Area(s), through the use of schedules over Direct Current Tie(s), will be implemented in accordance with these Protocols, North American Electric Reliability Corporation (NERC) scheduling protocols, and in compliance with NERC operating policies. Scheduling must also be in accordance with any applicable Federal Energy Regulatory Commission tariffs.*

*ERCOT will perform schedule confirmation with the applicable interconnected non-ERCOT Control Area(s) and, if appropriate, will coordinate the approval process for the NERC tags as both the ERCOT Control Area and on behalf of ERCOT TSPs.*

### 2.4.3.2 Linkage of Schedules with Interconnected Non-ERCOT Control Area Schedules

**REFERENCE:** Protocol Section 4.4.18.2, Linkage of Schedules with Interconnected Non-ERCOT Control Area Schedules

*ERCOT will match the Supply and Obligation schedules submitted by the QSEs with interconnected non-ERCOT Control Area schedules obtained through the NERC Scheduling Process to confirm schedules and perform checkouts with adjacent interconnected non-ERCOT Control Areas. Entities submitting NERC tags for DC Tie schedules must identify the appropriate ERCOT QSE on the NERC tag. ERCOT will determine the linkage between interconnected non-ERCOT Control Area schedules and Supply and Obligation schedules submitted by QSEs. QSE schedules creating an ERCOT export across a DC Tie are an Obligation. QSE schedules creating an ERCOT import across a DC Tie are a Supply. If the interconnected non-ERCOT Control Area schedule exceeds the QSE schedule to or from the DC Tie, ERCOT will deny the interconnected non-ERCOT Control Area schedule with the applicable interconnected non-ERCOT Control Area(s). If any QSE's Supply or Obligation schedule indicated as being received or delivered to or from a DC Tie that does not match the non-ERCOT Area schedule(s) as confirmed or linked by ERCOT, ERCOT shall settle those imbalances according to Section 6.8.1.13, Resource Imbalance and/or Section 6.9.5.2, Settlement For Balancing Energy for Load Imbalances.*

### 2.4.3.3 Operation of DC Ties

**REFERENCE:** Protocol Section 4.4.18.3, Operation of DC Ties

*ERCOT will confirm interconnected non-ERCOT Control Area schedule profiles with the DC Tie operator, who will control the tie to the schedules agreed to by both the designated Security Coordinator for the interconnected non-ERCOT Control Area and ERCOT.*

### 2.4.4 Temporary Deviations from Scheduling Procedures

**REFERENCE:** Protocol Section 4.8, Temporary Deviations from Scheduling Procedures

*If ERCOT is unable to comply with any of the deadlines in Sections 4.4, Day Ahead Scheduling Process, or Section 4.5, Adjustment Period Scheduling Process, it may temporarily deviate from those timing requirements to the extent necessary to ensure the secure operation of the ERCOT System. Temporary measures may include varying the timing requirements as specified in Section 4.4.19, Decision to Extend Day Ahead Scheduling Process to Two Day Ahead Scheduling Process, or omitting one or more procedures in the Scheduling Process. In such an event, ERCOT shall immediately declare an Emergency Condition and notify all QSEs of the following:*

- (1) Details of the affected timing requirements and procedures;*
- (2) Details of any interim requirements;*
- (3) An estimate of the period for which the interim requirements will apply; and*
- (4) Reasons for the temporary variation.*

*If, despite the variation of any time requirement or the omission of any procedure, ERCOT is unable to operate the Day Ahead Scheduling Process, ERCOT may abort the Day Ahead Scheduling Process and require all schedules to be submitted in the Adjustment Period.*

*If, despite the variation of any time requirement or omission of any step, ERCOT is unable to operate the Adjustment Period Scheduling Process, ERCOT may abort the Adjustment Period process and operate under its Operating Period procedures.*

*If ERCOT implements a Two Day Ahead Scheduling Process, that process shall be as described in Section 4.4.19, Decision to Extend Day Ahead Scheduling Process to Two Day Ahead Scheduling Process.*

## **2.4.5 Real-Time Schedules**

### **2.4.5.1 Dynamic Schedule**

**REFERENCE:** Protocol Section 4.9.1, Dynamic Load Schedules

*QSE's may use dynamic power signals to control generation to match a metered Load in order to minimize the QSE's exposure to the Balancing Energy market. To implement the Dynamic Schedule the QSE will send Real Time telemetry to ERCOT that is equal to the metered Load, which the QSE wishes to follow. ERCOT will integrate the signal for each Settlement Interval and provide the integrated signal to settlement as the scheduled Obligation for that metered Load. Settlement will use this integrated value as a scheduled Supply for that interval for the QSE. At settlement the integrated values will be used as a Supply or Obligation schedule.*

*The QSE's schedule will include one Supply Resource (or fleet) designated to follow the Dynamic Schedule for a Load. The designated Supply schedule will be estimated in the same manner as the designated Load. At settlement, the estimated schedule for the designated Resource will be replaced with the integrated final power signal from the dynamic Load.*

**REFERENCE:** Protocol Section 4.9.2, Approval of the Use of Dynamic Load Schedules

- (1) *Each QSE desiring to use Dynamic Load Schedules must submit a proposal of the Dynamic Schedule to ERCOT for analysis of Congestion impacts and reliability in accordance with the Operating Guides.*
- (2) *Subject to number (1) above, any QSE representing Non Opt-In Entities that own, had under construction, or had contractual rights to Generation Resources, as of May 1, 2000, may use Dynamic Schedules. Once a Non Opt-In Entity (NOIE) offers Customer Choice, it must submit a new proposal for Dynamic Load Scheduling to ERCOT.*
- (3) *ERCOT will approve dynamic scheduling proposals on a case-by-case basis. Approval will be based on the schedule's impact on ERCOT's ability to determine and manage Congestion, ERCOT's ability to monitor Generation Resource and Load behavior associated with the schedule and the schedule's impact on system reliability. QSEs representing Non-Opt In Entities, which submit proposals in accordance with (1) and (2) above will be accepted by ERCOT.*
- (4) *New proposals for Dynamic Load Schedules within Congestion Zones will be considered after June 1, 2001 and across Congestion Zones after June 1, 2002.*

**REFERENCE:** Protocol Section 4.9.3, Principles for Dynamic Schedules

- (1) *All power signals for Dynamic Schedules must be sent to ERCOT in Real Time via telemetry.*
- (2) *Each Dynamic Load Schedule must be tied to a Load meter or group of Load meters. This includes Load that is calculated by subtracting interchange telemetry from actual generation telemetry, appropriately adjusted for T&D Losses. A Load or group of Loads that is/are dynamically scheduled can only be followed by Generation Resources represented by the same QSE as the Load.*
- (3) *Each Dynamic Load Schedule will indicate the dynamic power signal that will be used to create the final schedule.*
- (4) *Dynamic Load Schedules tied to Load meters (or groups of Load meters) may be used between Congestion Zones.*
- (5) *A QSE using Dynamic Load Schedules shall send a dynamic power signal or signals to ERCOT.*
- (6) *Each QSE with a Dynamic Load Schedule will include in its schedules and plans submitted to ERCOT, an estimate for the integration of the schedule for each Settlement Interval. These schedule integration estimates will be used for allocation of RPRS costs.*
- (7) *ERCOT will integrate the dynamic power signal sent by a QSE for each Settlement Interval. This integrated signal shall replace the estimate and will be used in settlement as the final schedule. Dynamic Schedules do not alter the settlement process for metered Loads.*
- (8) *If a signal is lost for any reason, ERCOT will use the final schedule for Settlement purposes.*
- (9) *ERCOT will use the dynamic power signal in each of the applicable QSE's SCE equation.*

ERCOT may approve other Dynamic Scheduling proposals by QSEs on a case-by-case basis. Approval will be based on the Dynamic Schedule's impact on ERCOT Control Area Authority's ability to:

- Determine and manage Congestion,
- Monitor Generation Resource and Load behavior associated with the schedule, and
- Determine impact on system reliability.

**2.4.5.2 Responsibility Transfer (RspT) Schedules****REFERENCE:** Protocol Section 4.9.4.1, Approval of the Use of Responsibility Transfers

- (1) *Intra-zonal Responsibility Transfers (RspTs) will be approved unless ERCOT determines it cannot accommodate these transfers without compromising reliability or settlement accuracy.*
- (2) *Each QSE that proposes to use an RspT must submit a proposal of the RspT to ERCOT for analysis of Congestion impacts and reliability in accordance with the Operating Guides. The proposal for each RspT shall identify:*
  - (a) *Controlling Entity;*
  - (b) *Following Entity;*

- (c) Congestion Zone;
- (d) Maximum value;
- (e) Units supplying energy; and
- (f) Other information required by ERCOT.

**REFERENCE:** Protocol Section 4.9.4.2, Principles for Responsibility Transfers

- (1) *RspT may be used to shift responsibility for Supply of a defined maximum amount of MWs from one QSE to another QSE within the same Congestion Zone after the close of the Adjustment Period. As the RspT changes the responsibility for Supply of one QSE there must be an equal and opposite change in the responsibility for Supply of the other QSE.*
- (2) *One of the QSEs will act as the controller of the Real Time Dynamic signal. That Controlling Entity (CE) will send a Real Time power signal to ERCOT representing that QSE's power commitment to the other QSE, the Following Entity (FE).*
- (3) *ERCOT will use the dynamic power signal from the CE in its calculation of the CE's SCE. ERCOT will also use the dynamic power signal from the CE to calculate an equal and opposite value to use in calculation of the FE's SCE. The FE will use a signal from the CE to calculate its (the FE's) SCE.*
- (4) *ERCOT will integrate the dynamic power signal from the CE for each Settlement Interval and use this value as an offset in the CE's settlement for Resource imbalance. An equal but opposite offset will be used in the FE's settlement for Resource imbalance.*
- (5) *If the signal from the CE is lost, ERCOT will use the last good value received from the CE until the CE manually replaces the value, or the signal is restored.*

**[PRR428: Add Section 4.9.4.3 upon system implementation]**

**4.9.4.3 Principles for Responsibility Transfers For RMR Units**

- (1) *RspT may be used to schedule energy from an RMR Resource's QSE to ERCOT.*
- (2) *The RMR Resource's QSE will act as the controller of the Real Time Dynamic signal. The QSE will send a Real Time power signal to ERCOT representing the amount of RMR energy being delivered from RMR Resources to ERCOT by Congestion Zone. The dynamic signal will be consistent with and will not exceed the RMR deployment instructions from the final Delivery Plan and/or subsequent Adjustment Period changes, and the operation and availability of the RMR Resources.*
- (3) *ERCOT will use the dynamic power signal from the RMR QSE in its calculation of the RMR QSE's SCE.*
- (4) *ERCOT will integrate the dynamic power signal from the RMR QSE for each Settlement Interval and use this value as an offset in the RMR QSE's settlement for Resource imbalance.*

- (5) *If the signal from the Controlling Entity (CE) is lost, ERCOT will use the last good value received from the CE until the CE manually replaces the value, or the signal is restored.*

ERCOT may approve other Responsibility Transfers proposed by QSEs on a case-by-case basis. Approval will be based on the impact of the Dynamic Schedule on the ERCOT Control Area Authority's ability to:

- Determine and manage Congestion.
- Monitor Generation Resource and Load behavior associated with the schedule.
- Determine impact on system reliability.

### 2.4.5.3 Reliability Must Run Units

The following is the ERCOT Control Area Authority Day Ahead Scheduling Process for Reliability Must Run Units (RMR) Units and Black Start Resources:

DAY AHEAD HOUR	ERCOT RESPONSIBILITY
0900	Provide initial Delivery Plan to QSEs representing RMR and/or Synchronous Condenser Units where a Market Solution potentially cannot exist.
1630	Provide updated Delivery Plan to QSEs representing RMR and/or Synchronous Condenser Units where a Market Solution does not exist.

**REFERENCE:** Protocol Section 6.5.9, Reliability Must Run Service

- (1) *Upon receiving Notice from a Generation Entity as described in Protocols Subsection 6.5.9.1, Application and Approval of RMR Agreements, ERCOT may enter into RMR Agreements and begin procurement of RMR Service according to the provisions of this section.*
- (2) *Before entering into an RMR Agreement, ERCOT shall assess alternatives to the proposed RMR Agreement. The list of alternatives ERCOT should consider include (as reasonable for each type of reliability concern identified):*
  - a) *Redispatch/reconfiguration through operator instruction;*
  - b) *Remedial Action Plans;*
  - c) *Special protection schemes initiated on unit trips or transmission outages; and*
  - d) *Load response alternatives once a suitable Load response service is defined and available.*
- (3) *ERCOT shall reasonably attempt to minimize the use of RMR Facilities. ERCOT shall have the right to Dispatch an RMR Unit at any time for transmission reliability. ERCOT will*

*Dispatch the unit as early as possible once conditions are identified that require the use of the RMR Unit, as defined in Section 4, Scheduling and the RMR Agreement.*

- (4) *Each RMR Unit must meet technical requirements specified in Section 6.10 Ancillary Services Qualification, Testing and Performance Standards.*
- (5) *RMR Service is a contracted service between Generation Entities and ERCOT. The term of any RMR Agreement shall not exceed twelve (12) months except where a Generation Entity must make a significant capital expenditure to meet environmental regulations or to ensure availability in order to continue operating the unit so as to make an RMR Agreement in excess of twelve (12) months appropriate, in ERCOT's opinion and the ERCOT Board has approved a multi-year agreement. The term of a multi-year RMR Agreement shall reflect the RMR Replacement Option determined in Section 6.5.9.1, Initiation and Approval of RMR Agreements, item (11). The RMR Standard Agreement is included in Section 22, Protocols Agreements.*
- (6) *A Generation Resource is eligible for RMR status based on criteria established by ERCOT indicating its operation is necessary to support ERCOT System reliability. A combined cycle Facility will be treated as a single unit for RMR purposes unless the combustion turbine and the steam turbine can operate separately. If the steam turbine and combustion turbine can operate separately, and the steam turbine is powered by waste heat from more than one combustion turbine, the combustion turbine(s) accepted for RMR Service and a proportionate portion of the steam turbine will be treated as a single unit for RMR purposes. If the combustion turbine accepted for RMR Service can operate separately from the steam turbine, and only the combustion turbine is accepted as an RMR Unit, the RMR Energy Price will be reduced by the value of the combustion turbine's waste heat calculated at the Gas Price Index, except when the steam turbine is off-line. ERCOT shall post the criteria upon which it evaluates whether an RMR Unit meets the test of operational necessity to support ERCOT System reliability. A Generation Entity can obtain RMR Agreements only where necessary to ensure ERCOT System reliability according to the Operating Guides.*
- (7) *A Generation Entity cannot be compelled to enter into an RMR Agreement. Owners of Generation Resources that are uneconomic to remain in service can voluntarily petition ERCOT for contracted RMR status by following the process in Subsection 6.5.9.1, Application and Approval of RMR Agreements. ERCOT will be required to determine whether the unit is necessary for system reliability based on the criteria set forth in Subsection 6.5.9(6). If ERCOT determines that the nominated unit is required for system reliability, the Generation Entity may request ERCOT to allow operation as a Synchronous Condenser in place of RMR operation. If Synchronous Condenser operation is offered by the Generation Entity, ERCOT shall accept Synchronous Condenser operation unless ERCOT reasonably determines that a Synchronous Condenser operation is not adequate to meet system reliability according to the Operating Guides.*
- (8) *ERCOT must contract for the entire capacity of each RMR Unit.*
- (9) *RMR Units may not participate in the bilateral capacity and energy markets, including Self-Arranged Ancillary Services. RMR Units may participate in the Balancing Energy Service market during times when ERCOT has requested the RMR Unit to run at less than full*

*capacity, provided such participation does not limit availability to ERCOT to less than the Operational and Environmental Limitations as described in the RMR Agreement. ERCOT will endeavor to Dispatch an RMR Unit prior to procuring OOMC, OOME, or Zonal OOME Services from other Generation Entities, if economic to do so, based on ERCOT's knowledge at the time, and provided that the RMR Unit supplies equivalent reliability support as would the OOMC, OOME, or Zonal OOME Service, and further provided that the availability constraints of the RMR Unit are maintained. Within two (2) weeks following any month in which an RMR Unit is dispatched, the owner/operator of the RMR Unit will inform ERCOT of the RMR Unit's remaining availability.*

- (10) *RMR Units are dispatched by ERCOT when necessary to provide ERCOT System security, including any emergency situation.*
- (11) *ERCOT will treat the undeployed energy from RMR Units like any other unit for purposes of Balancing Energy Service Up provided the time of use constraints of the RMR Unit are maintained.*
- (12) *ERCOT will administer RMR Agreements in such a way as to minimize the use of RMR Units as much as practicable. ERCOT will provide to all Market Participants all information relative to the use of RMR Units including energy deployed.*
- (13) *The Generation Entity which owns the RMR Unit may not use the RMR Unit for:*
  - (a) *Participation in the bilateral energy market;*
  - (b) *Self-provision of energy except for plant auxiliary Load obligations under the RMR Agreement;*
  - (c) *Provision of Self Arranged Ancillary Services to any Entity; and*
  - (d) *Ancillary Services markets, except for incremental bids into the Balancing Energy Services market to the extent allowed in the RMR Agreement.*

**REFERENCE:** Protocol Section 6.7.8, **DEPLOYMENT OF RMR SERVICE**

- (1) *If a bid-based solution is not available and in Emergency Conditions, ERCOT shall have the option to Dispatch a contracted RMR Unit at any time for voltage support or localized transmission limitations, but it must Dispatch the unit as early as possible (if conditions merit) once conditions are identified that require the use of the RMR Unit and only to the extent of megawatt loading necessary to correct the voltage support or localized transmission limitation.*
- (2) *ERCOT must elect to use Resources under an RMR Agreement or MRA Agreement before issuing an OOME or Zonal OOME Dispatch Instruction subject to the terms of the Agreement, if practical.*
- (3) *ERCOT will deploy RMR Units in accordance with the RMR Agreement and MRA Resources in accordance with the MRA Agreement. RMR Agreements with ERCOT are expected to include limitations on the total service hours, megawatt-hour output, and the number of starts available to ERCOT for each RMR Unit.*



- (4) *ERCOT shall issue Dispatch Instructions via the Messaging System for any RMR Unit Dispatch or MRA Resource Dispatch. Any revisions to those instructions must be communicated via revised Dispatch Instructions.*
- (5) *In the event that ERCOT orders an RMR Unit or MRA Resource to operate to sustain reliable ERCOT System operation in any Operating Day, ERCOT will post on the MIS as soon as possible, but no later than the next Business Day, for such Operating Day:*
  - (a) *Each Resource receiving an RMR or MRA Dispatch Instruction for each interval;*
  - (b) *The amount of RMR or MRA energy ERCOT requested from each Resource for each interval; and*
  - (c) *The binding transmission constraint (contingency and/or overloaded element(s)) causing RMR or MRA deployments.*
- (6) *If ERCOT orders an RMR Unit or MRA Resource to operate to sustain reliable ERCOT System operation in any Operating Day, ERCOT will, on or before the Business Day following the day of issuance of the Initial Statement for the Operating Day on which ERCOT issued the Dispatch Instruction, as described in Section 9.2.3, Initial Statements, post on the MIS the amount of RMR or MRA energy actually provided by each RMR or MRA Unit for each interval of the subject Operating Day.*
- (7) *ERCOT shall publicly post an annual forecast of the Dispatch pattern it expects for each contracted RMR Unit and MRA Resource as well as monthly and week-ahead forecasts regarding its use of such Resources.*
- (8) *ERCOT will adjust the amount of Balancing Energy acquired due to the impact of RMR Energy deployed and energy deployed from MRA Resources. If adjustments made by ERCOT would result in the QSE exceeding its scheduled amount of generation, then the affected QSE must not accommodate these changes by adjusting other Resources such that the Schedule Control Error is minimized. ERCOT will not assess URC charges to the QSE as a result of these adjustments for the interval. The RMR may implement a Responsibility Transfer between its QSE and ERCOT for energy delivered under an RMR Agreement to minimize the impact of RMR scheduling on its QSE.*

## 2.5 Ancillary Services

### 2.5.1 ERCOT Responsibilities

**REFERENCE:** Protocol Section 6.3.1, ERCOT Responsibilities

- (1) *ERCOT, through its Ancillary Services function, shall develop the Operating Day Ancillary Services Plan for the ERCOT System, and the Day Ahead Ancillary Service Obligation which will be assigned based on Load Ratio Share data, by LSE, aggregated to the QSE level. Unless otherwise provided in these Protocols, a QSE's allocation for Ancillary Service Obligation will be determined for each hour according to that LSE's Load Ratio Share computed by ERCOT. The LSE Ancillary Service allocation for the Day Ahead Ancillary Service Obligation shall be based on the hourly Load Ratio Share from the Initial Settlement data, for the Operating Day that is fourteen (14) days before the day in which the Obligation is being calculated, as defined in Section 9.2, Settlement Statements, for the same hour and day of the week multiplied by the quantity of the service in the Operating Day Ancillary Service Plan.*
- (2) *ERCOT shall procure required Ancillary Services not self-arranged by QSEs.*
- (3) *ERCOT accepts Ancillary Service bids only from QSEs.*
- (4) *ERCOT shall allow the same capacity to be bid as multiple Ancillary Services types recognizing that this capacity may only be selected for one service.*
- (5) *ERCOT shall ensure provision of Ancillary Services to all ERCOT System Market Participants in accordance with these Protocols.*
- (6) *ERCOT shall not discriminate when obtaining Ancillary Services from QSEs submitting Ancillary Service bids. ERCOT shall not discriminate between Self-Arranged Ancillary Services and ERCOT-procured Ancillary Services when dispatching Ancillary Services.*
- (7) *For AS that are not self-arranged, ERCOT shall procure any additional Resources ERCOT requires during the Day-Ahead Scheduling Process, the Adjustment Period process, or the Operating Period.*
- (8) *ERCOT shall procure Resources that are used to provide Reliability Must-Run Service or Black Start Service through longer-term Agreements.*
- (9) *Following submission of QSE self-arranged schedules, ERCOT will identify the remaining amount of Ancillary Services that must be acquired in order to complete ERCOT's Day-Ahead Ancillary Services Plan. Regulation Up, Regulation Down, Responsive, and Non-Spinning services will be procured by ERCOT on the timeline described in Section 4, Scheduling.*
- (10) *ERCOT will not profit financially from the market. ERCOT will follow the Protocols with respect to the procurement of Ancillary Services and will not otherwise take actions regarding Ancillary Services with the intent to influence, set or control market prices.*

- (11) *ERCOT will provide that Market Clearing Prices are posted on the Market Information System (MIS) in a timely manner as stated in Section 12.4.1, Scheduling Information, of these Protocols. ERCOT will monitor Market Clearing Prices for errors and will “flag” for further review questionable prices before posting, and make adjustments or notations in the posting if there are conditions that cause the price to be questionable. ERCOT may only correct the price consistent with these Protocols.*
- (12) *ERCOT shall post the aggregated ERCOT AS Bid Stacks in accordance with Section 12.4.2, Ancillary Service Related Information of these Protocols.*
- (13) *ERCOT will, through procurement processes specified in these Protocols, procure Ancillary Services as required and charge QSEs for those Ancillary Services in accordance with these Protocols.*
- (14) *ERCOT will ensure ERCOT electric network reliability and adequacy and will afford the market a reasonable opportunity to supply reliability solutions.*
- (15) *ERCOT will not substitute one type of Ancillary Service for another.*
- (16) *ERCOT shall make reasonable efforts to minimize the use of OOMC, Zonal OOME, or contracted RMR Facilities. This includes entering into MRA Agreements with Resources selected through the planning process, pursuant to Section 6.5.9.2, to provide services to meet reliability requirements at lower total expected costs than would otherwise be provided by RMR Agreements.*
- (17) *ERCOT will provide timely information to those Resource units providing OOMC and RMR Services as to the specific use of each unit dispatched.*

***LANGUAGE EXTRACTED FROM PROTOCOL SECTION 6.1, ANCILLARY SERVICES REQUIRED BY ERCOT (IN MODIFIED FORM)***

***THE TYPES OF ANCILLARY SERVICES REQUIRED BY ERCOT ARE DESCRIBED BELOW.***

<b>ANCILLARY SERVICE TYPE</b>	<b>DEFINITION</b>	<b>ERCOT CONTROL AREA AUTHORITY ACTION</b>
Regulation Service – Down And Regulation Service- Up	Generation Resource capacity provided by a QSE to control frequency within the ERCOT System which is controlled minute by minute (normally by an AGC System).	a. Regulation-down power is deployed in response to a change in ERCOT System frequency above the target system frequency.  b. Regulation up power is deployed in response to a change in ERCOT System frequency below the target system frequency.
Balancing Energy Service	The provision of incremental or decremented energy dispatched by Settlement Interval to meet the balancing needs of the ERCOT System.	Deployed to:  a. Restore regulation control room by replacing Regulation Service energy with Balancing Energy Service.  b. To ensure that the net energy for Regulation Service up and down is minimized.  c. To ensure Zonal Congestion is managed

ANCILLARY SERVICE TYPE	DEFINITION	ERCOT CONTROL AREA AUTHORITY ACTION
Responsive Reserve Service	<p>Operating reserves ERCOT maintains to restore the frequency of the ERCOT System within the first few minutes of an event that causes a significant deviation from the standard frequency.</p> <p>The provision of power and energy by:</p> <ul style="list-style-type: none"> <li>➤ Unloaded Generation Resources that are On-line,</li> <li>➤ Resources controlled by high set under-frequency relays, or</li> <li>➤ Direct Current (DC) tie-line response. The DC tie-line response must be fully deployed within fifteen (15) seconds on the ERCOT System after the under frequency event.</li> </ul>	<p>Normally None – Responsive Reserve deploys automatically through governor action.</p> <p>Or</p> <p>Deployed for the Operating Hour in response to loss-of-Resource contingencies on the ERCOT System.</p>
Non-Spinning Reserve Service	<ul style="list-style-type: none"> <li>➤ Off-line Generation Resource capacity, or reserved capacity from On-line Generation Resources, capable of being ramped to a specified output level within thirty (30) minutes, or</li> <li>➤ Loads acting as a Resource that are capable of being interrupted within thirty (30) minutes and that are capable of running (or being interrupted) at a specified output level for at least one (1) hour.</li> </ul>	<p>Deployed for the Operating Hour in response to loss-of-Resource contingencies, load forecasting error, or other contingency events on the ERCOT System.</p>
Replacement Reserve Service	<p>Bringing into available service a Resource capable of providing additional Balancing Energy Service to ERCOT. (Normally forcing unit commitment)</p>	<p>Deployment of Loads or non-synchronized Generation Resources in order to make available additional Balancing Energy Service.</p>

<b>ANCILLARY SERVICE TYPE</b>	<b>DEFINITION</b>	<b>ERCOT CONTROL AREA AUTHORITY ACTION</b>
Voltage Support	The provision of Generation Resource capacity whose power factor and output voltage level can be scheduled by ERCOT to maintain transmission voltages within acceptable limits throughout the ERCOT System in accordance with Operating Guide 2.10.	Direct the scheduling of Voltage Profiles at the high voltage side of generator busses to maintain transmission voltages on the ERCOT System.
Black Start Service	The provision of Resources under a Black Start Agreement, which are capable of self-starting without support from the ERCOT System in the event of a blackout.	Provide emergency Dispatch Instructions to begin restoration of the ERCOT System to a secure operating state after a total or partial blackout.
Reliability Must-Run Service	The provision of Generation Resource capacity and/or energy Resources under a Reliability Must-Run (RMR) Agreement.	Direct the operation of units which otherwise would not operate and which are necessary to provide voltage support, stability or management of localized transmission constraints under first contingency criteria, where Market Solutions are not available or cost effective.
Out-Of-Merit Capacity Service	Generation or Loads acting as a Resource capable of providing additional Balancing Energy Service.	<p>When capacity insufficiency, Congestion, or other reliability needs exist and a Market Solution does not exist: Deployed to ensure:</p> <ul style="list-style-type: none"> <li>a. Regulation Service in either direction is not depleted during the interval, and</li> <li>b. The net energy for Regulation Service up and down is minimized.</li> </ul>

ANCILLARY SERVICE TYPE	DEFINITION	ERCOT CONTROL AREA AUTHORITY ACTION
Out-Of-Merit Energy Service	The provision of incremental or decremented energy dispatched from a specific Resource by Settlement Interval in Real Time to meet the balancing needs of the ERCOT System when no Market Solution exists or in declared emergencies.	Dispatched to provide Balancing Energy Service when no Market Solution exists for resolving Congestion or if required in declared emergencies.

ERCOT shall procure and deploy Ancillary Services on behalf of QSEs.

## 2.5.2 Responsive Reserve

### 2.5.2.1 Obligation

The ERCOT Responsive Reserve Obligation is a minimum of 2300 MW.

### 2.5.2.2 Allocation Of Obligation

The daily Responsive Reserve Obligations will be available on the Operating Reserve Display on the ERCOT information system. The allocation of the Responsive Reserve Obligation (RRO) between Load Entities will be based on Protocol Section 6.3.1, ERCOT Responsibilities.

### 2.5.2.3 Types Of Responsive Reserve

**REFERENCE:** Protocol Section 6.5.4, Responsive Reserve Service (In Part)

- (1) *Responsive Reserve Service (RRS) may be provided by:*
- (a) *Unloaded Generation Resources that are On-line;*
  - (b) *Resources controlled by high-set under-frequency relays;*
  - (c) *Hydro Responsive Reserves;*
  - (d) *From DC Tie response that stops frequency decay or; and*
  - (e) *From Load Resources capable of controllably reducing or increasing consumption under Dispatch control (similar to AGC) and that immediately respond proportionally to frequency changes (similar to generator governor action).*

*The minimum amount of RRS provided by Generation Resources and Load Resources capable of controllably reducing or increasing consumption under Dispatch control (similar to AGC) and that immediately respond proportionally to frequency changes (similar to generator governor action) shall be as specified in the Operating Guides. QSE's Resources providing RRS must be On-line and capable of ramping to the awarded output level within ten (10) minutes of the notice to deploy energy,*

*must be immediately responsive to system frequency, and must be able to maintain the scheduled level for the period of service commitment. The amount of RRS on an individual Generation Resource may be further limited by requirements of the Operating Guides.*

Responsive reserves provided by a QSE shall meet the following requirements:

- (1) In no case shall more than twenty percent (20%) of the Net Dependable Capability for any non-Combined Cycle thermal unit be used as Responsive Reserve.
- (2) In no case shall more than twenty percent (20%) of the combined Net Dependable Capability for any Combined Cycle Block with one or more CTs or GTs coupled to a Steam Turbine, with their net maximum capability aggregated together, be used as Responsive Reserve.
- (3) In no case shall more than twenty percent (20%) of the Net Dependable Capability for any hydro unit with a five percent (5%) droop setting operating as a generator be used as Responsive Reserve.
- (4) In no case shall capacity from any wind unit be used as Responsive Reserve.

### ***Interruptible Responsive Reserve***

**REFERENCE:** Protocol Section 6.5.4, Responsive Reserve Service (In Part)

- ...(2) *A QSE's Load acting as a Resource must be loaded and capable of unloading the scheduled amount of RRS within ten (10) minutes of instruction by ERCOT and must either be immediately responsive to system frequency or be interrupted by action of under-frequency relays as specified by the Operating Guides...*
- ...(5) *Interruptible Loads acting as a Resource providing RRS must provide a telemetered output signal, including breaker status and status of the under-frequency relay...*
- ...(8) *The amount of Resources on high-set under-frequency relays providing RRS will be limited to fifty percent (50%) of the total ERCOT RRS requirement. ERCOT may reduce this limit if it believes that this amount will have a negative impact on reliability or if this limit would require additional Regulation to be deployed as prescribed in Section 6.4.1, Standards for Determining Ancillary Services Quantities....*

Telemetered interruptible Load controlled by under-frequency relays (UFR) for automatic interruption may be provisionally qualified and eligible to participate as a responsive reserve Resource as specified in Protocol Section 6.10.1, Introduction.

To become provisionally qualified as a provider of Responsive Reserve Service (RRS), the Load shall complete the following requirements:

- Register as a Resource with ERCOT;
- Complete Asset Registration of Load acting as Resource (LaaR);
- Provide ERCOT the appropriate UFR Load affidavit;
- Provide ERCOT with a simplified one-line diagram between relay and operating device;



- Provide ERCOT with a UFR set point calibration documentation including: the relay used to shed Load at low frequency, the relay set point, the relay operating time, and the typical loads to be shed;
- Test to verify appropriate voice communications are in place for verbal Dispatch Instructions by ERCOT;
- Be capable of interruption by automatic operation of the UFR(s) set to initiate the interruption whenever system frequency reaches a specific value. The initiation setting of the relay shall not be any lower than 59.7 Hz.;
- Have frequency measuring relays with a time delay of no more than twenty (20) cycles (or 0.33 seconds for relays that do not count cycles). Total time from the time frequency first decays to a value low enough to initiate action of the UFR(s) to the time Load is interrupted should be no more than thirty (30) cycles, including all relay and breaker operating times.
- Be capable of interruption within ten (10) minutes of receipt of a verbal Dispatch Instruction from ERCOT;
- Be telemetered through the QSE to the ERCOT Control Area Authority with a real-time signal of total interruptible Load on high-set under-frequency relays, breaker status, the status of the high set under-frequency relay, and signals representing the Load Resource's MW response to instruction; and,
- Be able to remain interrupted during actual event until replaced by other Net Dependable Capability. In no case may interrupted Load be restored to service without the approval of the ERCOT operator;

To become and remain fully qualified as a provider of RRS, the Load shall complete the requirements above and the following:

- Pass simulated or actual testing according to ERCOT procedure; and,
- Perform verification testing as described in Section 6, Reports and Forms.

### ***DC Tie Responsive Reserve***

A Direct Current (DC) Tie may be used as Responsive Spinning Reserve up to thirty (30) MW subject to the following constraints:

- The tie shall respond with increased deliveries to ERCOT or decreased deliveries from ERCOT at an ERCOT frequency of 59.9 Hz;
- The response rate will not be less than thirty (30) MW per minute;
- The response delay will not exceed four (4) seconds;
- The response will be retained until the ERCOT frequency has recovered to a level at or above 60.0 Hz or as directed by the Control Area Authority;
- A QSE claiming DC Tie RRS must demonstrate the existence of contracts agreeing to provide the required response with the DC Tie operator;

- A QSE claiming DC Tie RRS must have agreement with the Control Area on the opposite side of the DC Tie involved approving the amount and conditions.

### ***Hydro Responsive Reserve***

Hydro unit(s) operating in the synchronous condenser fast response mode may be designated as Hydro Responsive Reserve provided that:

- Only the amount of a hydro unit's demonstrated ten (10) second response may be used as Responsive Reserve subject to verification as described in Protocol Section 6.10, Ancillary Service Qualification, Testing and Performance Standards;
- Automatic controls using the "fast response" mode must be in operation to initiate a move to the generating mode. The initiation setting of the automatic controls shall not be any lower than 59.9 Hz and the unit must be generating within four (4) seconds of the set relay operation;
- A Real Time signal of the MW output of hydro units being operated in the synchronous condenser fast response mode is telemetered to the ERCOT.

## **2.5.3 Non-Spinning Reserve Service (NSRS)**

### **2.5.3.1 Types of Non-Spin Reserve Service**

#### **As Provided by Generating Resources**

**REFERENCE:** Protocol Section 6.5.5, Non-Spinning Reserve Service (NSRS) (In Part)

- (1) *A QSE supplying 30-Minute Non-Spinning Reserve Service (30MNSRS) shall not submit Balancing Energy Service bids representing that capacity...*

Each generating Resource providing Non-Spinning Reserve Service (NSRS) must meet additional technical requirements specified in Protocol Section 6.10, Ancillary Service Qualification, Testing and Performance Standards.

#### **As Provided by Loads acting as a Resource (LaaR)**

**REFERENCE:** Protocol Section 6.5.5, Non-Spinning Reserve Service (NSRS) (In Part)

- (1) *A QSE supplying 30-Minute Non-Spinning Reserve Service (30MNSRS) shall not submit Balancing Energy Service bids representing that capacity.*
- (2) *A QSE having Resources supplying BESCNSRS shall have those Resources qualified and pre-approved by ERCOT according to a procedure described in the Operating Guides. On-line Resources qualified for BESCNSRS shall be separated into a separate virtual resource using generation meter splitting as described in Section 10.3.2.1, Generation Meter Splitting. ERCOT shall establish a procedure for qualifying and including these BES-Capable On-line Non-Spinning Reserve Service (On-line BESCNSRS) virtual Resources. ERCOT may provide one hundred twenty (120)-day provisional approval pending qualification according to Operating Guides requirements...*

...(5) *Loads providing Non-Spinning Reserve Service (NSRS) must provide a telemetered output signal, including breaker status.*

Telemetered Load available to be interrupted within thirty (30) minutes of an ERCOT deployment may be provisionally qualified and eligible to provide non-spinning reserve as specified in Protocol Section 6.10.1, Introduction.

To become provisionally qualified as a provider of NSRS, the Load shall complete the following requirements:

- Register as a Resource with ERCOT;
- Complete Asset Registration of LaaR;
- Provide ERCOT the appropriate Non-Spinning Load affidavit;
- Test to verify appropriate voice communications are in place for verbal Dispatch Instructions by ERCOT;
- Be telemetered through the QSE to the ERCOT Control Area Authority with the Load MW of each LaaR breaker, breaker status, and signals representing the Load Resource's MW response to instruction; and,
- Be able to remain interrupted during an ERCOT deployment for a minimum of one (1) hour up to a maximum of the hours of service awarded.

To become and remain fully qualified as a provider of NSRS, the Load shall complete all the requirements for provisional qualification identified above and the following:

- Respond successfully to an actual ERCOT deployment; or pass simulated or actual testing according to ERCOT's Procedure; and,
- Perform verification testing as described in Section 6, Reports and Forms.

#### **2.5.4 Replacement Reserve Service (RPRS)**

**REFERENCE:** Protocol Section 6.5.6, Replacement Reserve Service (In Part)

(1) *Replacement Reserve Service (RPRS) is provided by Resources that may otherwise be unavailable to ERCOT in the hours that ERCOT requests RPRS. These Resources may include Generation Resources that are expected to be Off-line in the requested hours and Loads acting as a Resource that are declared to be available in the Resource Plan but are not committed to any service Obligation.*

(2) *Resources providing RPRS must provide a telemetered output signal, including breaker status...*

...(6) *Generation Resource and Loads acting as a Resource accepted for RPRS must be able to respond in the hours for which they have been selected to provide the Ancillary Service...*

Each Generation Resource providing RPRS must meet additional technical requirements specified in Section 6.10, Ancillary Service Qualification Testing and Performance.

Telemetered Load available may be provisionally qualified and eligible to provide replacement reserve as specified in Protocols Section 6.10.1, Introduction.

To become provisionally qualified as a provider of RPRS, the Load shall complete the following requirements:

- Register as a Resource with ERCOT;
- Complete Asset Registration of LaaR;
- Provide ERCOT the appropriate Affidavit;
- Test to verify appropriate voice communications are in place for verbal Dispatch Instructions by ERCOT;
- Be telemetered through the QSE to the ERCOT CAA with the Load MW of each LaaR breaker, breaker status, and signals representing the Load Resource's MW response to instruction; and,
- Be capable of interruption within 10 minutes of receipt of a verbal Dispatch Instruction from ERCOT;

To become and remain fully qualified as a provider of RPRS, the Load shall complete all the requirements for provisional qualification identified above and the following:

- Respond successfully to an actual ERCOT deployment; or pass simulated or actual testing according to ERCOT Procedure; and,
- Perform verification testing as described in Operating Guides Section 6, Reports and Forms.

### 2.5.5 Balancing Energy Service

**REFERENCE: PROTOCOL SECTION 6.5.2, BALANCING ENERGY SERVICE (IN PART)**

*The Balancing Energy Service bids shall consist of Balancing Energy Service Up, Balancing Energy Service Down, BES-Capable Non-Spinning Reserve Service (BESCNSRS), and BUL bids. All Balancing Energy Service provider bids must be entered by the close of the Adjustment Period for the effective Operating Hour and shall become an Obligation at the close of the Adjustment Period. However, Balancing Energy Service provider bids may be withdrawn at any time prior to the close of the Adjustment Period. The portion of a QSE's Balancing Energy Service Up bid deployable in one (1) interval that may be provided by Off-line Generation Resources shall be limited to no more than the aggregate of qualified output amounts from Quick Start Units which have been demonstrated via the qualification testing process described in the Operating Guides. The QSE may utilize any remaining capacity from Quick Start Units in subsequent intervals once the Quick Start Units are On-line...*

**REFERENCE: PROTOCOL SECTION 6.10.3, ANCILLARY SERVICES QUALIFICATION AND PORTFOLIO TEST METHODS (IN PART)**

*Only QSEs that have been qualified and tested may be used to provide Ancillary Services. ERCOT shall develop and operate its qualification and testing program to meet the following requirements for each Ancillary Service.*

*ERCOT may grant a “Provisional Qualification,” for a period not to exceed forty-five (45) days, to QSEs that are required to be, but have not yet been tested. For all Ancillary Service testing, QSEs must utilize Resources that are to be used by the QSE to provide the Ancillary Services to be tested. Notwithstanding the failure of a QSE with Provisional Qualification to meet the applicable Ancillary Service criteria, such QSE may provide such Ancillary Service to the extent permitted by the terms of the Provisional Qualification.*

*A QSE shall be qualified and tested to provide Service prior to initial operation and every five years thereafter...*

*...ERCOT is authorized to call up to two unannounced, unscheduled qualification tests after presenting to the QSE supporting information of an indication that a Resource may not be able to meet its stated Net Dependable Capability during any calendar year.*

*QSEs may qualify by using either Generation Resource(s) or Load(s) Acting as a Resource (LaaR(s)). If a QSE qualifies by using only a LaaR then the QSE may only provide Ancillary Services using LaaRs and will not be qualified to provide Ancillary Services using Generation Resources. However, if a QSE successfully completes the qualification using Generation Resource(s), that QSE will be qualified to provide Ancillary Services from both Generation Resources and LaaRs.*

*ERCOT may grant a “Provisional Qualification,” for a period not to exceed ninety (90) days, to a QSE that has performed an Ancillary Service qualification test (or tests) in good faith but failed to qualify due to problems that, in the sole discretion of ERCOT, are determined to be non-critical for the purpose of providing one or more Ancillary Services. Notwithstanding the failure of a QSE with Provisional Qualification to meet the applicable Ancillary Service criteria, such QSE may provide such Ancillary Service to the extent permitted by the terms of the Provisional Qualification.*

**REFERENCE: PROTOCOL SECTION 6.10.3.4, BALANCING ENERGY (IN PART)**

- (1) *Testing using Generation Resource(s)*
  - (a) *A test for Balancing Energy Service shall be performed during a continuous eight (8) hour window agreed on by the QSE and ERCOT.*
  - (b) *ERCOT shall confirm the date and time of the test with the QSE using both the primary and alternate voice circuits to validate the voice circuits.*
  - (c) *At any time during the window, selected by ERCOT when market and reliability conditions allow and not previously disclosed to the QSE, ERCOT shall notify the QSE using ERCOT’s Messaging System requesting it to provide an amount of Balancing Energy. The QSE shall acknowledge the start of the test. During the sixty (60) minute duration of the test, within the limits of requested qualification, ERCOT will vary the amount of Balancing Energy requested.*

- (d) *A QSE may qualify to provide only Balancing Energy Down Service using only Uncontrollable Renewable Resources by providing Balancing Energy Down Service, within the limits of requested qualification, in an amount available from the Uncontrollable Renewable Resource's Resource Plan at the time of the Dispatch Instruction. All measurements shall confirm the reduced delivery of energy due to the deployment of Balancing Down Energy Service when the generation amount of the Uncontrollable Renewable Resource is less than or equal to the Uncontrollable Renewable Resource's Resource Plan, less the amount requested by ERCOT.*
- (e) *On successful demonstration of all test criteria, ERCOT shall qualify the QSE is capable of providing Balancing Energy and shall provide a copy of the certificate to the QSE...*

For purposes of testing Quick Start Units providing Balancing Energy Service, ERCOT will test each unit by issuing a unit-specific Dispatch Instruction for the MW amount that the QSE requesting to have the Quick Start Units be qualified to provide. ERCOT's procedures for testing Quick Start Units providing Balancing Energy Service shall be consistent with the ERCOT Protocols Sections 6.10.3, Ancillary Services Qualification Criteria and Portfolio Test Methods, and 6.10.3.4, Balancing Energy. The Quick Start Units will be qualified to provide only the output amount observed at the end of the ten (10) minute Balancing Energy ramp period.

## **2.6 Changes in System Status**

### **2.6.1 Changes in Resource Status**

**REFERENCE:** Protocol Section 5.5.1, Changes in Resource Status (In Part)

*The QSE will notify ERCOT of an unplanned change in Resource status as soon as practicable following the change. The QSE representing the Resource will report any changes in Resource status to ERCOT in the Resource Plan by the beginning of the next hour following the change in status...*

### **2.6.2 Changes in Transmission Facility Status**

**REFERENCE:** Protocol Section 5.5.2, Changes in Transmission Facility Status

*The TDSP will notify ERCOT of any changes in status of Transmission Facility elements as provided and clarified in the ERCOT procedures. The TDSP will notify ERCOT of any other Transmission Facility status as soon as practicable following the change. In addition, any short-term inability to meet minimum TSP or DSP reactive requirements shall be immediately reported to ERCOT by way of the TSP.*

## 2.7 Outage Coordination

### 2.7.1 ERCOT Control Area Authority Responsibilities

The following table outlines the action to be taken by ERCOT Control Area Authority as a result of various Outage events:

EVENT	CONTROL AREA AUTHORITY ACTION
Submission of schedules for Planned Outages and Maintenance Outages of Transmission Facilities.	Evaluation of all Planned Outages and Maintenance Outages to ensure the Outage does not result in a violation of the security criteria.
Submission of Planned Outages and Maintenance Outages of Reliability Must Run (RMR) Units.	Evaluation of all Planned Outages and Maintenance Outages to ensure the Outage does not result in a violation of the security criteria.
Submission of Black Start Unit Outages	Evaluation of all requested Planned Black Start Outages to ensure that unavailability may not cause a violation of the security criteria and that a valid methodology of restoring ERCOT from black start conditions without the requested unit exists (Subject to the terms of the applicable Black Start Agreement) per Protocol Section 8.1.1, Role of ERCOT.
Transmission Facility Forced Outages and resultant maintenance on related facilities.	Evaluate the impact of Forced Outage on the ERCOT System, perform constraint analysis and implement changes to generation or transmission to restore or maintain secure operating conditions. Previously approved transmission outages may be adjusted or withdrawn if necessary. (Per Protocol Section 8.2.4, Management of Transmission Forced Outages or Maintenance Outages.)
Receipt of schedules of Planned Outages for Resources;	Monthly – prepare an assessment of Load vs. Available capacity by Congestion Zone by week for the next 52 weeks, including the effects of commercial constraints. Post the adequacy of supply for each Congestion Zone on the MIS.

### 2.7.2 Forced Outages

#### 2.7.2.1 Energy Resources

The Control Area Authority shall be advised of all Forced Outages of ANY energy resource with a capability greater than 10 MW within one minute.

#### 2.7.2.2 Transmission

Forced Outages of transmission lines and other lines or equipment that affect power flows or transfer capacity will be reported immediately by the TDSP to the ERCOT System Operator.



The TDSP may be required to provide ERCOT supporting information justifying the removal of transmission equipment from service according to Protocol Section 8.2.4, Management of Transmission Forced Outages or Maintenance Outages.

When a Forced Outage affects ERCOT, ERCOT shall take immediate remedial steps to ensure that other facilities are not loaded beyond security limits.

### **2.7.2.3 Sabotage Information Exchange**

A TDSP, QSE, PGC or any ERCOT entity shall inform the ERCOT operator when:

- It is suspected or identified that multi-site sabotage has occurred
- It is suspected or identified that a single-site sabotage of a critical facility has occurred.

ERCOT shall inform NERC and governmental agencies of the threat in accordance with current laws and regulations.

The ERCOT operator may inform other TDSPs or QSEs of the event(s), if, in the opinion of ERCOT, the situation impacts ERCOT System reliability or security.

## **2.7.3 Scheduled Outages**

### **2.7.3.1 Generation**

ERCOT Control Area Authority will record and monitor each Resource Entity's annual maintenance schedule for all generating units owned or operated by the Resource Entity that are within the ERCOT System, as part of ERCOT Control Area Authority overall system reliability analysis.

ERCOT Control Area Authority shall have the option of approving or rejecting a Planned Outage or a Maintenance Outage, prior to the removal from service of a RMR, a Synchronous Condenser Unit or Black Start Resource.

### **2.7.3.2 Transmission**

ERCOT Control Area Authority shall coordinate all proposed maintenance of all lines or equipment that affects power flows or transfer capacity of the ERCOT System.

ERCOT Control Area Authority, jointly with TDSPs shall attempt to minimize the effect of simultaneous outages of lines on the reliability of ERCOT. ERCOT Control Area Authority will establish priorities, when necessary, in accordance with the following to provide adequate time for required maintenance.

When a request for removal of transmission equipment from service is received, ERCOT should conduct studies prior to approval to demonstrate that:

- The capacity of remaining ERCOT transmission equipment shall not be exceeded.
- ERCOT shall remain single contingency secure. Remedial Action Plans may be depended upon to recover from overloads under some contingency conditions.

- ERCOT may limit the loading on generating units to a value that can be delivered by remaining transmission lines.

## 2.8 Congestion Management

### 2.8.1 Overview of ERCOT Coordinated Congestion Management

**REFERENCE:** Protocol Section 7.1, Overview of ERCOT Congestion Management

*ERCOT employs a Zonal Congestion management scheme that is flow-based, whereby the ERCOT Transmission Grid, including attached Generation Resources and Load, will be divided into a predetermined number of Congestion Zones. Each Congestion Zone is defined such that each Generation Resource or Load within the Congestion Zone boundaries has a similar effect on the loading (Shift Factor) of Transmission Facilities between Congestion Zones. For purposes of solving Zonal Congestion the Shift Factor will be assumed the same for: (i) all Generation Resources deemed likely to vary their output and (ii) Loads within a Congestion Zone. Therefore any imbalance between Loads and Generation Resources in a Congestion Zone will be deemed to have the same impact on a given loading between Congestion Zones.*

*This Congestion management scheme applies zonal Shift Factors, determined by ERCOT, to predict potential Congestion on Commercially Significant Constraints (CSCs) under the known topology of the ERCOT System. The zonal Shift Factors determined by ERCOT should most closely represent the effect of Generation Resources deemed likely to vary their output and Loads in the Congestion Zone on the CSCs with the current topology of ERCOT System. This scheme is used in the Day Ahead and Adjustment Periods to evaluate potential Congestion and notify Market Participants accordingly. ERCOT also uses this scheme, along with other factors, to determine if it should procure Replacement Reserve Service in a Congestion Zone to provide additional Balancing Energy Service to solve expected Congestion. ERCOT will use monthly zonal Shift Factors to post and analyze the Schedule impact on CSCs until it implements calculations of interval Shift Factors in the system.*

*ERCOT will manage transmission Congestion and categorize the cost of Congestion management as either Zonal Congestion management costs or Local Congestion management Costs. Zonal Congestion management costs are those costs attributable to managing Congestion on CSCs or predefined Closely Related Elements (CRE). The costs of managing Zonal Congestion will be directly assigned to Qualified Scheduling Entities (QSEs) based on the impact of each QSE's portfolio on CSCs. All other Congestion management costs are considered Local Congestion management costs.*

*ERCOT will use the Zonal Congestion management model with Shift Factors of Generation Resources and Loads on CSCs and zonal Balancing Energy Service Market Clearing Price for Energy (MCPE) to determine the Shadow Prices of energy across corresponding CSCs. In addition, ERCOT will directly assign to QSEs the costs of any Replacement Reserve Service (RPRS) procured on a zonal basis for Congestion management purposes. ERCOT will use these Shadow Prices in settlement to directly assign to QSEs the cost of managing Zonal Congestion to QSEs.*

*ERCOT will set the Shadow Price cap at a level that ERCOT calculates to be in alignment with the prevailing system-wide offer cap defined in paragraph (g)(6) of PUCT SUBST. R. 25.505, Resource Adequacy in the Electric Reliability Council of Texas Power Region, and Section 6.11, System-Wide Offer Caps. In some cases, such as where two (2) or more CSCs are simultaneously binding, MCPEs may be generated that are at levels higher than the prevailing system-wide offer cap or lower than the Balancing Energy offer floor. When that occurs, ERCOT shall make Real Time or ex-post*

*adjustments to zonal MCPs to ensure that MCPs do not exceed the system-wide offer cap or fall below the Balancing Energy offer floor, and adjust CSC Shadow Prices accordingly. ERCOT shall describe the ERCOT Board-approved process for making price adjustments in a Market Operations Bulletin that will be posted on the Market Information System (MIS) Public Area. ERCOT shall send a Notification to Market Participants informing them of any change to the Shadow Price cap at least ten (10) days prior to implementation of the new system-wide offer cap.*

*The Local Congestion management scheme relies on a more detailed Operational Model to determine how each particular Resource or Load impacts the transmission system. This model does not use portfolios and uses the current known topology of the transmission system.*

*ERCOT will uplift the cost to solve Local Congestion pro rata to each QSE based on its Load Ratio Share.*

*ERCOT will manage Congestion by:*

- (1) Evaluating the levels of Zonal Congestion and any other Congestion during the Day Ahead, the Adjustment Period and the Operating Period using appropriate models of the ERCOT Transmission Grid;*
- (2) Examining the impacts of QSE energy schedules on CSCs;*
- (3) Posting on the MIS, the total megawatt quantity impacts on every CSC, and allowing QSEs to adjust schedules to mitigate potential Congestion on the CSCs;*
- (4) Procuring during the Adjustment Period, as needed, RPRS to use with other Resources for which QSEs have submitted Balancing Energy bids to provide sufficient capacity for Balancing Energy flows in the Operating Hour while respecting operational limits of the ERCOT Transmission Grid;*
- (5) Determining settlement for QSEs providing RPRS procured to manage Congestion; and*
- (6) Determining settlement for QSEs providing Balancing Energy associated with resolving Zonal Congestion.*

*ERCOT will carry out these steps in accordance with this Section and the Scheduling and Ancillary Service Scheduling and Selection requirements in Sections 4 and 6, respectively.*

## 2.9 Requirements for Under-Frequency Relaying

### 2.9.1 Automatic Firm Load Shedding

At least 25% of the ERCOT System Load that is not equipped with high-set under-frequency relays shall be equipped at all times with provisions for automatic under-frequency load shedding. The under-frequency relays shall be set to provide load relief as follows:

Frequency Threshold	Load Relief
59.3 Hz	5% of the ERCOT System Load (Total 5%)
58.9 Hz	An additional 10% of the ERCOT System Load (Total 15%)
58.5 Hz	An additional 10% of the ERCOT System Load (Total 25%)

The Control Area Authority will, prior to the peak each year, survey each TDSP's compliance with the automatic load shedding steps above, and report its findings to the Technical Advisory Committee of ERCOT. For minimum compliance, TDSPs are obligated to meet the prescribed percent values at all times. It is not permitted to use rounding off to meet the minimum. ERCOT will direct a review of the automatic firm load shedding program whenever warranted by conditions in the ERCOT System. At a minimum, this review will follow the Reliability and Operations Subcommittee (ROS) directed dynamic simulations of automatic firm load shedding conducted at five-year intervals beginning in the summer of 2001.

TDSPs shall ensure, to the extent possible, and under the direction of the Control Area Authority, that load equipped with under-frequency relays are dispersed geographically throughout the ERCOT System to minimize the impact of load shedding within a given geographical area. Customers equipped with under-frequency relays shall be dispersed without regard to which LSE serves the customer. TDSPs shall ensure that the under-frequency relays connected to each load will operate with a fixed time delay of no more than 30 cycles. Total time from the time when frequency first reaches one of the values specified above to the time load is interrupted should be no more than 40 cycles, including all relay and breaker operating times. If the frequency drops below 58.5 Hz, the ERCOT System Operator shall determine additional steps to continue operation.

If a loss of load occurs due to the operation of under-frequency relays, a TO may rotate the physical load interrupted to minimize the duration of interruption experienced by individual customers or to restore the availability of under-frequency load-shedding capability; however, in no event shall the initial total amount of load without service be decreased by a TO without the approval and direction of the ERCOT System Operator. TOs, directed by the Control Area Authority, shall make every reasonable attempt to restore load, either by automatic or manual means, to preserve system integrity. This will allow load equipped with under-frequency relays to be available for interruption should there be a subsequent

under-frequency event. TDSPs shall exercise extreme caution in restoring load so that the capability limits of generating units and transmission lines are not exceeded.

Whenever possible, TDSPs shall not manually drop load connected to under-frequency relays during the implementation of Level 3 of the Energy Emergency Alert.

### 2.9.2 Generators

If under-frequency relays are installed, these relays shall be set such that the automatic removal of individual generating units from the ERCOT System meet the following requirements:

<b>Frequency Range</b>	<b>Delay to Trip</b>
Above 59.4 Hz	No automatic tripping (Continuous operation)
Above 58.4 Hz up to And including 59.4 Hz	Not less than 9 minutes
Above 58.0 Hz up to And including 58.4 Hz	Not less than 30 seconds
Above 57.5 Hz up to And including 58.0 Hz	Not less than 2 seconds
57.5 Hz or below	No time delay required

No prearranged instruction that conflicts with the above limits will be given for the manual removal of an otherwise operable generating unit. This Operating Guide is not intended to conflict with the plant operator's responsibility to protect generating units from potentially damaging operating conditions. While this guide does not address the removal of generating units for frequency deviations above 60 Hz, it is realized that the generating unit operating restrictions below 60 Hz apply equally to operation of a generating unit above 60 Hz.

## 2.10 System Voltage Profile

### 2.10.1 Introduction

The System Voltage Profile is a predetermined distribution of desired nominal voltage set points across the ERCOT System.

ERCOT shall coordinate and conduct studies with the TDSPs to determine the normally desired Voltage Profile for all Generation Resource busses in the ERCOT System.

ERCOT shall establish and update Voltage Profiles at points of interconnection of Generation Resources to maintain system voltages within established limits.

### 2.10.2 Maintaining Voltage Profile

ERCOT has the responsibility for monitoring the Voltage Profile within their Transmission System. ERCOT has the responsibility to control the Voltage Profile and should use the following guides to maintain the Voltage Profile:

FUNCTION	ACTION
Operations Engineering	<ul style="list-style-type: none"> <li>➤ All voltage limits must be based on sound engineering studies that use current network models. TDSP study results should be made available to the Control Area Authority.</li> <li>➤ Transfer limits shall reflect voltage and/or reactive restrictions.</li> </ul>
Coordination	<ul style="list-style-type: none"> <li>➤ Entities must coordinate high voltage limits in order to guarantee that the Maximum Continuous OverVoltage (MCOV) of equipment is not exceeded. TDSPs shall notify ERCOT of all limits.</li> <li>➤ Low voltage limits must be coordinated in order to prevent one Entity from being a burden to another.</li> <li>➤ Voltage limits shall not be violated during all normal and first contingency conditions.</li> <li>➤ The operation of all Reactive Power devices under the control of a Transmission Operator or a QSE will be coordinated under the direction of ERCOT to maintain transmission voltage levels established by ERCOT. Static reactive devices will be managed to ensure that adequate dynamic Reactive Reserves are maintained at all times.</li> </ul>
Notification	<ul style="list-style-type: none"> <li>➤ Generation Resources with voltage problems shall notify their host TDSP. TDSPs shall notify other affected TDSPs and the Control Area Authority for any voltage problem potentially affecting interconnected operations.</li> <li>➤ The Control Area Authority will monitor actions and may request</li> </ul>

FUNCTION	ACTION
	assistance to solve the problems to assure the reliability of the interconnection.
Response	<ul style="list-style-type: none"> <li>➤ When the voltage levels deviate from established limits, ERCOT Control Area Authority shall take immediate steps to relieve the condition using all available reactive resources.</li> </ul>
Monitoring	<ul style="list-style-type: none"> <li>➤ TDSPs shall provide telemetry to the Control Area Authority that monitors all major transmission bus voltages. A routine schedule shall be maintained by the TDSP to calibrate the telemetry.</li> </ul>
Controls	<ul style="list-style-type: none"> <li>➤ ERCOT Control Area Authority must be aware of the locations of available reactive capability.</li> <li>➤ ERCOT shall maintain displays to monitor Voltage Profiles and reactive flows.</li> <li>➤ Controls to maintain Voltage Profiles may include capacitor switching, reactor switching, autotransformer tap changing, generator reactive Dispatch, transmission line switching, and Load shedding.</li> </ul>
Documentation	<ul style="list-style-type: none"> <li>➤ Each TDSP must maintain a voltage/reactive plan for normal and Emergency Conditions. This document shall be provided to adjacent TDSPs as well as ERCOT Control Area Authority.</li> </ul>
Emergency or Abnormal Conditions	<ul style="list-style-type: none"> <li>➤ Transmission systems shall be designed so that effective Reactive Reserves shall be available without de-energizing other Facilities or shedding Load under normal conditions.</li> <li>➤ Major transmission lines shall be kept in service during light Load as much as possible. Lines can only be removed after all applicable reactive controls are implemented and studies show that reliability will not be degraded.</li> <li>➤ Voltage reduction shall not be done on the transmission system unless coordinated with adjacent TDSPs.</li> </ul>

### 2.10.3 Special Consideration for Nuclear Power Plants

In all planning studies and Real Time operations, ERCOT and TDSPs shall maintain the switchyard voltage at each operating nuclear power plant at a nominal value that does not violate its licensing basis with the Nuclear Regulatory Commission. ERCOT shall notify the QSE representing a nuclear power plant of the result of any studies where the voltage at the plant switchyard cannot be adequately maintained. The TDSP shall monitor the voltage in Real Time and provide notice to the QSE representing the nuclear power plant of any voltage inadequacy at the plant switchyard that cannot be corrected within 30 minutes.



High and low limits on switchyard voltage at each nuclear power plant necessary to meet these requirements shall be specified in ERCOT Procedures.

#### **2.10.4 Reactive Considerations for Gas and Steam Turbine Power Plants**

##### ***REFERENCE: PROTOCOL SECTION 6.5.7.2, QSE RESPONSIBILITIES (IN PART)***

...(7) *QSE shall advise ERCOT Operations whenever their Generation Resources are not operating at a power factor level as specified in the Operating Guides. Upon such notice, ERCOT Operations, in conjunction with the appropriate TSP, shall investigate the situation with the goal of restoring the reported unit's operation to within the specified power factor range. Actions that ERCOT may take include the addition or removal of transmission reactive devices to/from service or a request to another Generator Resource within electrical proximity for the production of leading or lagging VARS (as appropriate) so as to equitably share the need for voltage support among Generation Resources. Requests arising within the context of this subsection may not result in the operation of a Generation Resource outside of the specified reactive operating range. Accordingly, Generation Resources are expected to voluntarily comply with these requests. Nothing in this subsection is meant to supersede ERCOT's Dispatch authority in the event of emergency operations...*

##### ***REFERENCE: PROTOCOL SECTION 6.10.9, REACTIVE POWER SUPPLY FROM GENERATION RESOURCES REQUIRED TO PROVIDE VSS PERFORMANCE CRITERIA (IN PART)***

...(4) *Except under Force Majeure conditions or ERCOT-permitted operation of the generating unit, if a Generation Resource required to provide VSS fails to maintain transmission system voltage at the point of interconnection with the TSP within two percent (2%) of the scheduled voltage while operating at less than the maximum reactive capability of the generating unit, ERCOT may, at its discretion, report this to the ERCOT Compliance Office...*

#### **2.10.4.1 Maintaining System Voltage**

Each generator shall attempt to maintain the Voltage Profile. Although the generator shall maintain the voltage to the best of its ability within the limits of the individual machine, the TDSP, to which the generator is connected, shall monitor and direct, by communicating with the Generation Resource (at the discretion of the Generation Resource) or the QSE responsible for operation of the Generation Resource, the reactive output of the machines having direct effect on the local system voltage. Under TDSP declared emergency conditions, TDSPs may directly dispatch the reactive output of the Generation Resource and follow up with notification of the QSE. The TDSP will, using Good Utility Practices, equalize the reactive output of the generators based on size (net dependable MW capability), reactive capability, reactive limits and system voltage impact.

#### **2.10.4.2 Unit Dispatch Beyond the Unit Reactive Limit**

Each generator shall respond to ERCOT instructed voltage control, including exceeding its URL, as specified in Protocol Section 6.8.4, Capacity Payments for Voltage Support Provided to ERCOT. For multi-generator busses, ERCOT shall not instruct any single generator to operate beyond its URL until all generators on line and interconnected at the same transmission bus have been instructed to their respective URLs.

## 2.11 External Control Area Inter-Ties

**REFERENCE:** Protocol Section 4.4.18.5, Inadvertent Energy Account

*Any difference between the scheduled net interchange and the actual net interchange at each DC Tie will be tracked in an Inadvertent Energy Account between ERCOT and each interconnected non-ERCOT Control Area. ERCOT will coordinate operation of the DC Tie(s) with the DC Tie Operator such that the Inadvertent Energy Account is maintained as close to zero as possible. Corrections of inadvertent energy between ERCOT and the interconnected non-ERCOT Control Areas will be in accordance with the NERC scheduling protocols and the Operating Guides.*

### 2.11.1 Control Area Operations

Control Area schedules between the ERCOT Control Area and interconnected non-ERCOT Control Area(s), through the use of schedules over Direct Current Tie(s), will be implemented in accordance with the ERCOT Protocols, North American Electric Reliability Corporation (NERC) scheduling protocols, and in compliance with NERC operating policies. Scheduling must also be in accordance with any applicable Federal Energy Regulatory Commission tariffs.

ERCOT Control Area Authority will perform schedule confirmation with the applicable interconnected non-ERCOT Control Area(s) and will coordinate the approval process for the NERC tags as both the ERCOT Control Area and on behalf of ERCOT Transmission Service Providers.

### 2.11.2 Operation of DC Ties

ERCOT Control Area Authority will confirm interconnected non-ERCOT Control Area schedule profiles with the DC Tie operator, who will control the tie to the schedules agreed to by both the designated Security Coordinator for the interconnected non-ERCOT Control Area and ERCOT.

Exports from ERCOT via DC Ties will be treated as a Load connected at transmission voltage.

Imports into ERCOT via DC Ties will be treated as generation injection located at the DC tie point.

Any changes in the interconnected non-ERCOT Control Area schedules due to a de-rating of the tie or other change within the NERC scheduling protocols will be communicated to ERCOT by the DC Tie Operator or designated security coordinator for the interconnected non-ERCOT Control Area.

ERCOT Control Area Authority will coordinate operation of the DC Tie(s) with the DC Tie Operator such that the Inadvertent Energy Account is maintained as close to zero as possible.

## 2.12 Document Control

### *Change History*

<b>Issue/Date</b>	<b>Reason for issue</b>
Version 0.1 November 30, 2000	Draft for Review
Version 0.2 December 29, 2000	Include Version 0.1 comments, Moved attachments to Appendix C, Discussion and Review by peer group
Version 0.3 January 19, 2001	Include comments from seminar
Version 0.4 February 5, 2001	Include comments from second seminar
Version 1.0 February 28, 2001	Updated from Working Group comments. Submitted to Technical Advisory Committee to approve handover to the Reliability Operating Subcommittee
February 1, 2003	OGRR123 – Section 2.5.2.4, increases the amount of interruptible load on high-set under frequency relays (UFR) participation Resources can provide Responsive Reserve Service from 25% to 35%.
March 1, 2003	Revised header to state “Section.”
April 1, 2003	OGRR124 revised Sections 2.4.2 & 2.8 to update Protocols references.
May 1, 2003	OGRR127 updated reference to Protocols Section 5.5.2 and deleted duplicate text after reference. Also update references to OG Section 6.
September 1, 2003	OGRR130 updated Section 2.2.4; OGRR131 updated Section 2.5.2.3, adds Sections 2.5.3 and 2.5.4.
November 1, 2003	OGRR137 deleted Section 2.5.2.4.
April 1, 2004	OGRR141 updated all of Section 2 with corrections and clarifications. OGRR142 updated Section 2.1.
May 1, 2004	OGRR144 updated Section 2.9.2.
June 1, 2004	OGRR145
February 1, 2005	OGRR158
April 1, 2005	OGRR159
May 1, 2005	OGRR149 added as boxed language; OGRR156
June 1, 2005	Admin OGRR168
July 1, 2005	Admin OGRR170
September 1, 2005	OGRR167, OGRR173
November 1, 2005	Admin OGRR177
December 1, 2005	OGRR171
February 1, 2006	Admin OGRR180
April 1, 2006	OGRR174, Admin OGRR183

Issue/Date	Reason for issue
June 1, 2006	Admin OGRR185
August 1, 2006	OGRR179
September 1, 2006	OGRR 149 unboxed; OGRR181;
December 1, 2006	OGRR186
January 1, 2007	Admin OGRR190
May 1, 2007	Admin OGRR195
July 1, 2007	Admin OGRR202
May 1, 2008	OGRR205, Admin OGRR207
June 1, 2008	Admin OGRR210
December 1, 2008	Admin OGRR215
March 1, 2009	OGRR213
April 1, 2009	OGRR221
May 1, 2009	OGRR213 (unboxed due to effective date)
June 8, 2009	OGRR222
July 1, 2009	Admin OGRR230

---

---

# ***ERCOT OPERATING GUIDES***

---

---

## **Section 3: Operational Interfaces**

---

---

### **QSE and TDSP Interface with ERCOT**

July 1, 2009

**PUBLIC**

# Contents

<b>3.</b>	<b>OPERATIONAL INTERFACES .....</b>	<b>3-4</b>
3.1	SYSTEM CONTROL INTERFACES WITH ERCOT .....	3-4
3.1.1	<i>Introduction</i> .....	3-4
3.1.2	<i>Compliance with Dispatch Instructions</i> .....	3-4
3.1.3	<i>Qualified Scheduling Entities</i> .....	3-6
3.1.4	<i>Power Generation Companies</i> .....	3-11
3.1.5	<i>Transmission and/or Distribution Service Providers</i> .....	3-25
3.1.6	<i>Responsibility For Equipment Ratings</i> .....	3-28
3.2	SCHEDULING INTERFACES WITH ERCOT .....	3-29
3.2.1	<i>Scheduling-Related Duties of Qualified Scheduling Entities</i> .....	3-29
3.2.2	<i>Scheduling Process</i> .....	3-31
3.2.3	<i>Procurement of Replacement Reserve Service Resources</i> .....	3-33
3.2.4	<i>Procurement of Additional Ancillary Services</i> .....	3-33
3.2.5	<i>Direct Current Tie Interconnection Day Ahead Scheduling Process</i> .....	3-34
3.2.6	<i>Dynamic Schedules</i> .....	3-34
3.2.7	<i>Approval of the Use of Responsibility Transfer (RspT) Schedules</i> .....	3-35
3.3	DOCUMENT CONTROL .....	3-38

## Protocol References

REFERENCE: PROTOCOL SECTION 5.4.4, COMPLIANCE WITH DISPATCH INSTRUCTIONS .....	3-4
REFERENCE: PROTOCOL SECTION 4.3.4, OPERATIONS OF THE QUALIFIED SCHEDULING ENTITY ..	3-6
REFERENCE: PROTOCOL SECTION 6.5.1.1, REQUIREMENT FOR OPERATING PERIOD DATA FOR SYSTEM RELIABILITY AND ANCILLARY SERVICE PROVISION .....	3-7
REFERENCE: PROTOCOL SECTION 4.4.15, QSE RESOURCE PLANS .....	3-9
REFERENCE: PROTOCOL SECTION 5.5.1, CHANGES IN RESOURCE STATUS (IN PART) .....	3-10
REFERENCE: PROTOCOL SECTION 5.5.1, CHANGES IN RESOURCE STATUS (IN PART) .....	3-10
REFERENCE: PROTOCOL SECTION 6.10.2, GENERAL CAPACITY TESTING REQUIREMENTS .....	3-14
REFERENCE: PROTOCOL, SECTION 6.10.3.5, REACTIVE SUPPLY FROM GENERATION RESOURCES REQUIRED TO PROVIDE VSS .....	3-16
REFERENCE: PROTOCOL SECTION 5.5.2, CHANGES IN TRANSMISSION FACILITY STATUS .....	3-25
REFERENCE: PROTOCOL SECTION 6.4.2, DETERMINATION OF ERCOT CONTROL AREA REQUIREMENTS (IN PART) .....	3-25
REFERENCE: PROTOCOL 6.5.7.1, GENERATION RESOURCES REQUIRED TO PROVIDE VSS INSTALLED REACTIVE CAPABILITY (IN PART) .....	3-25
REFERENCE: PROTOCOL 6.5.7.2, QSE RESPONSIBILITIES (IN PART) .....	3-25
REFERENCE: PROTOCOL SECTION 6.5.7.3, ERCOT RESPONSIBILITIES (IN PART) .....	3-26
REFERENCE: PROTOCOL SECTION 6.7.6, DEPLOYMENT OF VOLTAGE SUPPORT SERVICE (IN PART) .....	3-26
REFERENCE: PROTOCOL SECTION 4.3.2, SCHEDULE COMPONENTS .....	3-29
REFERENCE: PROTOCOL SECTION 4.3.3, SPECIAL SCHEDULING CONSIDERATIONS FOR SPLIT GENERATION METERS .....	3-30
REFERENCE: PROTOCOL SECTION 4.3.4, OPERATIONS OF THE QUALIFIED SCHEDULING ENTITY	3-31

REFERENCE: PROTOCOL SECTION 4.3.5, REQUIREMENT FOR BALANCED SCHEDULES (IN PART) 3-31  
 REFERENCE: EXTRACTED FROM PROTOCOL SECTION 4.1.1 AND OPERATING GUIDES SECTION 2.5.1  
 ..... 3-31  
 REFERENCE: PROTOCOL SECTION 4.1.2, ADJUSTMENT PERIOD SCHEDULING PROCESS (IN PART).. 3-32  
 REFERENCE: PROTOCOL SECTION 4.4.18.4, SETTLEMENT (IN PART) ..... 3-34  
 REFERENCE: PROTOCOL SECTION 4.9.1, DYNAMIC LOAD SCHEDULES ..... 3-34  
 REFERENCE: PROTOCOL SECTION 4.9.2, APPROVAL OF THE USE OF DYNAMIC LOAD SCHEDULES 3-34  
 REFERENCE: PROTOCOL SECTION 4.9.3, PRINCIPLES FOR DYNAMIC SCHEDULES ..... 3-35  
 REFERENCE: PROTOCOL SECTION 4.9.4.1, APPROVAL OF THE USE OF RESPONSIBILITY TRANSFERS  
 ..... 3-35  
 REFERENCE: PROTOCOL SECTION 4.9.4.2, PRINCIPLES FOR RESPONSIBILITY TRANSFERS ..... 3-36  
 REFERENCE: PROTOCOL SECTION 4.9.5, RESPONSIBILITY TRANSFER FOR BALANCING ENERGY  
 BIDDING ..... 3-37

## 3. Operational Interfaces

### 3.1 System Control Interfaces with ERCOT

#### 3.1.1 Introduction

ERCOT Control Area Authority, the Control Area Operator (CAO) of the ERCOT System, is authorized to take specific actions for the purpose of securely operating the ERCOT Transmission Grid in conformance with the standards specified in Protocol Section 5.2, North American Electric Reliability Corporation/ERCOT Tagging Procedures.

The following sections define the specific interface between Qualified Scheduling Entities and Transmission and/or Distribution Service Providers to allow the Control Area Authority to ensure the security and reliability of the ERCOT System, under normal operations. Emergency operation is fully described in Part 4 of this Guide. PGCs can communicate directly with ERCOT Control Area Authority under emergency and specific scheduling activities.

All other Entities operating in the ERCOT System interface either to the Qualified Scheduling Entities or the Transmission and/or Distribution Service Providers.

#### 3.1.2 Compliance with Dispatch Instructions

**REFERENCE: PROTOCOL SECTION 5.4.4, COMPLIANCE WITH DISPATCH INSTRUCTIONS**

- (1) *Each TDSP and each QSE within the ERCOT System shall comply fully and promptly with valid Dispatch Instructions, unless in the sole and reasonable judgment of the TDSP or QSE, such compliance would create a threat to safety, risk of bodily harm or damage to the equipment, or is otherwise not in compliance with these Protocols.*
- (2) *If the recipient of a valid Dispatch Instruction does not comply because in the sole and reasonable judgment of the TDSP or QSE, such compliance would create a threat to safety, risk of bodily harm or damage to the equipment, or is otherwise not in compliance with these Protocols, then, the TDSP or QSE must immediately notify ERCOT and provide the reason for non-compliance.*
- (3) *If the recipient of a Dispatch Instruction recognizes that the Dispatch Instruction conflicts with other valid instructions or is invalid, the recipient will immediately notify ERCOT of the conflict and request resolution.*
- (4) *Upon receipt of notice of non-compliance or conflict with Dispatch Instructions, ERCOT may, but is not required to, issue new Dispatch Instructions in response to the TDSP or QSE's notice.*
- (5) *ERCOT's final instruction in effect will apply for all Protocol-related processes. If the QSE does not comply after receiving the final instruction, the QSE shall remain liable for failure to meet its obligations under the Protocols and shall remain liable for any charges resulting from such failure.*



- (6) *ERCOT's final instruction to a TDSP in effect will apply for all Protocol-related processes. If the TDSP does not comply after receiving the final instruction, the TDSP shall remain liable for such failure under these Protocols in accordance with the TDSP's Agreement with ERCOT.*
- (7) *In all cases in which compliance with a Dispatch Instruction is disputed, both ERCOT and the QSE or TDSP shall document their communications, agreements, disagreements, and reasons for their actions, to enable resolution of the dispute through the ADR process in Section 20, Alternative Dispute Resolution.*

Each TDSP and each QSE within the ERCOT System shall comply fully and promptly with valid Dispatch Instructions.

The TDSP or QSE shall immediately notify ERCOT if the recipient of a valid Dispatch Instruction does not comply. The TDSP or QSE shall provide the reason for non-compliance in one of the following categories:

- Threat to safety;
- Risk of bodily harm;
- Damage to the equipment; or
- Not in compliance with the Protocols.

A recipient of a Dispatch Instruction shall immediately notify ERCOT Control Area Authority of any conflicts within acceptable limits and request resolution. Conflicts within acceptable limits are:

- The Dispatch Instruction conflicts with other valid instructions; or
- The Dispatch Instruction is invalid.

ERCOT Control Area Authority may, but is not required to, alter or retract Dispatch Instructions in response to the TDSP or QSE's notice of conflict.

ERCOT Control Area Authority's final Dispatch Instruction in effect to a QSE shall apply. If the QSE does not comply after receiving the final Dispatch Instruction, the QSE shall remain liable for failure to meet its obligations under the Protocols and shall remain liable for any charges resulting from such failure.

ERCOT Control Area Authority's final Dispatch Instruction to a TDSP in effect shall apply. If the TDSP does not comply after receiving the final Dispatch Instruction, the TDSP shall remain liable for such failure in accordance with the TDSP's Agreement with ERCOT.

ERCOT and the QSE or TDSP shall document the following information in the case of a dispute over compliance with a Dispatch Instruction:

- Communications;
- Agreements;
- Disagreements; and

- Reasons for their actions.

Documentation shall be retained for a minimum of 3 years or until the related dispute is resolved.

Each QSE, or their agent shall immediately forward any valid Dispatch Instruction to the appropriate Resource or group of Resources.

### 3.1.3 Qualified Scheduling Entities

#### 3.1.3.1 Operating Obligations

**REFERENCE: PROTOCOL SECTION 4.3.4, OPERATIONS OF THE QUALIFIED SCHEDULING ENTITY**

**Scheduling Center Requirement.** *A QSE shall maintain a 24-hour, seven-day-per-week scheduling center with qualified personnel for the purposes of communicating with ERCOT for scheduling purposes and for deploying the QSE's Ancillary Services in Real Time.*

**QSE Representative.** *Each QSE shall, for the duration of the Scheduling Process and settlement period for which the QSE has submitted schedules to ERCOT, designate a representative who shall be responsible for operational communications and who shall have sufficient authority to commit and bind the QSE.*

A QSE shall maintain a 24-hour, seven-day-per-week scheduling center with qualified personnel for the purposes of communicating with ERCOT for scheduling purposes and for deploying the QSE's Ancillary Services in Real Time. Each QSE shall provide the ERCOT Control Area Authority (CAA) with its written backup control plan to continue operation in the event the QSE's scheduling center becomes inoperable.

Each backup control plan shall be reviewed and updated annually and shall meet the following minimum requirements:

- Description of actions to be taken by QSE personnel to avoid placing a prolonged burden on ERCOT and other Market Participants.
- Description of specific functions and responsibilities to be performed to continue operations from an alternate location.
- Includes procedures and responsibilities for maintaining basic voice communications capabilities with ERCOT.
- Includes procedures for backup control function testing and the training of personnel.

As an option, the backup control plan may include arrangements made with another Entity to provide the minimum backup control functions in the event the QSE's primary functions are interrupted.

Each QSE shall, for the duration of the Scheduling Process and settlement period for which the QSE has submitted schedules to ERCOT, designate an individual who shall be responsible for operational communications and who shall have sufficient authority to commit and bind the QSE.

For connectivity requirements for backup sites, refer to Section 8.3.1.1, QSE Use of Domain Name Service (DNS) or ERCOT Web-Based Front Page for Site Failover.

**REFERENCE: PROTOCOL SECTION 6.5.1.1, REQUIREMENT FOR OPERATING PERIOD DATA FOR SYSTEM RELIABILITY AND ANCILLARY SERVICE PROVISION**

*Operating Period data will be used by ERCOT to monitor the reliability of the ERCOT System in Real Time, monitor compliance with Ancillary Service Obligations, perform historical analysis, and predict the short-term reliability of the ERCOT System using network analysis software. Each TDSP, at its own expense, may obtain such Operating Period data from ERCOT or from QSEs.*

- (1) *A QSE representing a Generation Entity that has Generation Resources connected to a TDSP shall provide the following Real Time data to ERCOT for each individual generating unit at a Generation Resource plant location and ERCOT will make the data available to the Generation Resource's host TDSP (at TDSP expense):*
- (a) *Gross and net real power, or  
Gross real power at the generator terminal and unit auxiliary load real power, or  
Net real power at the EPS meter and unit auxiliary load real power.*
  - (b) *Gross reactive power at the generator terminal*
  - (c) *Status of switching devices in the plant switchyard not monitored by the TDSP affecting flows on the ERCOT System;*
  - (d) *Frequency Bias of Portfolio Generation Resources under QSE operation;*
  - (e) *Any data mutually agreed by ERCOT and the QSE to adequately manage system reliability and monitor Ancillary Service Obligations;*
  - (f) *Generator breaker status;*
  - (g) *High Operating Limit; and*
  - (h) *Low Operating Limit.*

**[PRR590: Add items (i) and (j) upon system implementation:]**

- (i) *AGC status; and*
- (j) *Ramp rate.*

**[PRR307: Revise Section 6.5.1.1(1) and 6.5.1.1(1)(f) as follows when system change implemented.]**

- (1) *A QSE representing a Generation Entity or a Competitive Retailer that has Resources connected to a TDSP shall provide the following Real Time data to ERCOT for each individual generating unit or LaaR capable of controllably reducing or increasing consumption under Dispatch control (similar to AGC) and that immediately respond proportionally to frequency changes (similar to generator governor action) at a*

*Resource plant location and ERCOT will make the data available to the Resource's host TDSP (at TDSP expense):*

- (f) *Resource breaker status;*

***[PRR590: Add paragraph (2) and renumber subsequent paragraphs upon system implementation:]***

- (2) *A QSE representing Uncontrollable Renewable Resources is exempt from the requirements of Section 6.5.1.1(1)(i) and (j).*
- (2) *Any QSE providing Responsive Reserve and/or Regulation must provide for communications equipment to receive ERCOT telemetered control deployments of service power.*
- (3) *Any QSE providing Regulation Service must provide appropriate Real Time feedback signals to report the control actions allocated to the QSEs Resources.*
- (4) *Any QSE that represents a provider of Responsive Reserve, Non-Spinning Reserve, or Replacement Reserve using interruptible Load as a Resource shall provide separate telemetry of the real power consumption of each interruptible Load providing the above Ancillary Services, the LaaR response to Dispatch Instructions for each LaaR, and the status of the breaker controlling that interruptible Load. If interruptible Load is used as a Responsive Reserve Resource, the status of the high-set under frequency relay will also be telemetered.*
- (5) *Any QSE that represents a qualified provider of Balancing Up Load (BUL) need not provide telemetry but rather shall provide an estimate in Real Time representing the real power interrupted in response to the deployment of Balancing Up Load.*
- (6) *Real Time data for reliability purposes must be accurate to within three percent (3%). This telemetry may be provided from relaying accuracy instrumentation transformers.*

***[PRR590: Add paragraph (7) upon system implementation:]***

- (7) *A QSE representing a combined cycle plant may aggregate the AGC and ramp rate SCADA points for the individual units at a plant location into two distinct SCADA points (AGC and ramp rate) if the plant is configured to operate as such, i.e. gas turbine(s) and steam turbine(s) are controlled in aggregate from an AGC perspective.*

### 3.1.3.2 Daily Resource Plan

#### **REFERENCE: PROTOCOL SECTION 4.4.15, QSE RESOURCE PLANS**

*Each QSE that represents a Resource will present a Resource Plan to ERCOT at 1600. These Resources may be specific Generation Resources and/or Loads acting as Resources (LaaRs). The Resource Plan capacity should be sufficient to accommodate the combined quantity of energy and Ancillary Services scheduled by that QSE from the Resources that the QSE represents. The Resource Plan shall indicate the availability of the Resources represented by the QSE, including a lead-time status code, and the planned operating level of each Resource, for each hour of the Operating Day. The Resource Plan shall indicate the High Operating Limit (HOL) and Low Operating Limit (LOL), and High Sustainable Limit (HSL) and Low Sustainable Limit (LSL) by Resource. A Resource may be listed as unavailable to ERCOT if the Resource's capacity has been committed to markets in regions outside of ERCOT. ERCOT shall use other Resource Dispatch options to maintain system reliability prior to Dispatching a Generation Resource below its LOL. ERCOT shall request Qualifying Facilities (QF), hydro units, and/or nuclear to operate below their LOLs only after other Resource Dispatch options have been exhausted.*

*ERCOT shall produce renewable production potential forecasts for Wind-powered Generation Resources (WGRs) to be used as the planned operating level in the Resource Plan during Replacement Reserve Service (RPRS) procurements. The WGR Production Potential (WGRPP) is an hourly eighty-percent (80%) probability of exceedance forecast of energy production for each WGR. ERCOT shall use a probabilistic Total ERCOT Wind Power Forecast (TEWPF) and select the forecast that the actual total ERCOT WGR production is expected to exceed eighty-percent (80%) of the time (eighty-percent (80%) probability of exceedance forecast). To produce the WGRPP, ERCOT will allocate the TEWPF eighty-percent (80%) probability of exceedance forecast to each WGR such that the sum of the individual WGRPP forecasts equal the TEWPF forecast. ERCOT shall produce these forecasts using information provided by WGRs to their QSEs including meteorological information or models, WGR power production curves and Supervisory Control and Data Acquisition (SCADA). ERCOT shall provide forecasts for each WGR to the QSEs representing WGRs and shall deliver the forecasts before RPRS procurements to allow the QSEs to update the WGR Resource Plans. QSEs shall use the ERCOT-provided forecasts for WGRs as the planned operating level for the 1600 Resource Plan and prior to running an RPRS market in the Adjustment Period. The QSE may submit a lower operating level than the WGRPP forecast in the WGR Resource Plan if the WGR has communicated that it will be unavailable or operating at a reduced capability during an Operating Period which the forecast did not anticipate. QSEs representing only WGRs shall update their Resource Plans and schedules to reflect the expected wind-powered generation production after the close of the RPRS market. The energy schedules submitted by QSEs representing only WGRs should correspond with the Resource Plan scheduled energy output in order for Real Time balancing and the operator entered offset to perform properly. During Settlement Intervals in which QSEs representing only WGRs are using a Resource Plan modified due to insertion of the eighty-percent (80%) probability of exceedance forecast, ERCOT shall use the most recent available Resource Plan value prior to the ERCOT instruction to insert the eighty-percent (80%) probability of exceedance forecast.*

*QSEs shall use best efforts, consistent with Good Utility Practice, to continually update their Resource Plans to reflect the current and anticipated operating conditions of the Resources. ERCOT will monitor the performance of QSEs with respect to the submission of accurate Resource*

*Plans in accordance with the measures established in Section 4.10, Resource Plan Performance Metrics. ERCOT will work with individual QSEs as necessary to improve the individual QSE performance.*

**REFERENCE: PROTOCOL SECTION 5.5.1, CHANGES IN RESOURCE STATUS (IN PART)**

*The QSE will notify ERCOT of an unplanned change in Resource status as soon as practicable following the change. The QSE representing the Resource will report any changes in Resource status to ERCOT in the Resource Plan by the beginning of the next hour following the change in status...*

Each QSE that represents a Resource, either Load or Generation, shall submit to the ERCOT Control Area Authority by 1600 hours each day their Resource Plan for the next day.

The capacity of all Resources shown as available in the Resource Plan should be sufficient to accommodate the combined quantity of energy and Ancillary Services scheduled by that QSE from the Resources which the QSE represents.

The Resource Plan shall indicate the availability of all Resources represented by the QSE and the planned operating level of each Resource, for each hour of the Operating Day.

The Resource Plan shall indicate the High Operating Limit and Low Operating Limit of each Resource.

A Resource may be listed as unavailable to ERCOT if the Resource's capacity has been committed to markets in regions outside of ERCOT.

The QSE representing the Resource will report to ERCOT any changes in Resource status by updating its Resource Plan before the beginning of the next hour following the change in status.

### **3.1.3.3 Unplanned Load Changes**

**REFERENCE: PROTOCOL SECTION 5.5.1, CHANGES IN RESOURCE STATUS (IN PART)**

*The QSE will notify ERCOT of an unplanned change in Resource status as soon as practicable following the change. The QSE representing the Resource will report any changes in Resource status to ERCOT in the Resource Plan by the beginning of the next hour following the change in status...*

The QSE shall notify ERCOT Control Area Authority of an unplanned change in load resource status as soon as practical following the event.

The QSE representing the load that is to be used as a resource shall provide ERCOT Control Area Authority with an update of the load status. The update will be provided in the Resource Plan by the beginning of the next hour following the change in status.

Each QSE shall call on resources from which commitments have been made to provide Ancillary Services.

### 3.1.3.4 QSE Responsibility for Department of Energy (DOE) and NERC Reportable Events

QSEs shall provide ERCOT with the DOE Form OE-417 report for each DOE reportable event that happens in areas they represent. ERCOT, as the Control Area Authority, will forward these reports to the DOE and NERC as required.

### 3.1.4 Power Generation Companies

This Section defines the minimum requirements for the integration of generation facilities greater than 10 MW into the ERCOT System.

A generation facility shall be defined as any individual generating unit at a plant location that supplies energy to the ERCOT System.

Each generation facility shall meet the following general requirements in order to integrate into the ERCOT System.

- Physically located in the ERCOT Control Area,
- Represented by a QSE represented PGC, or directly by a QSE.

A QSE shall be the reporting Entity for a PGC and shall communicate with both ERCOT Control Area Authority and the TDSP maintaining the PGCs connection.

The QSE reporting for a PGC or a generation facility shall provide the following telemeter quantities for generation facilities greater than 10 MW to ERCOT Control Area Authority:

- Generator megawatts,
- Generator megavars,
- Generator energy (megawatt-hours),
- Substation equipment status, and
- Voltage where the facility connects to the Transmission Grid
- The directly connected TDSP may obtain any required data from ERCOT.

These quantities are fully described in Operating Guide 2.

The PGCs reporting QSE shall provide a separate, dedicated and reliable communications voice channel to each of ERCOT Control Area Authority and the directly connected TDSP and reliable data communications to both ERCOT Control Area Authority and the directly-connected TDSP.

The PGCs reporting QSE shall, as a minimum, provide adequate modeling information, as follows:

- Machine impedance and characteristics;
- Excitation system data, governor system constants;

- Transformer impedance; and
- Other relevant information.

This information is necessary to support ERCOT and TDSP's ability to perform operational and planning studies such as:

- Transient and Dynamic Stability
- Short Circuit
- Load Flow
- Reliability Evaluations

When in operation, the generation facility greater than 10 MW shall be staffed or monitored 24 hours per day, by personnel capable of making operating decisions and possessing the ability to control the generation facility output when requested by the representing QSE or the directly connected TDSP during Black Start procedures.

The generation facility shall perform maintenance, start-up, and operation in a reliable and safe manner consistent with Good Utility Practices.

The generation facility shall implement the following in a reliable and safe manner and in accordance with the switching procedure of the directly connected TDSP:

- Synchronizing of the generation to the ERCOT System,
- Transmission switchyard switching or clearances.

The operation of a generation facility shall conform to the requirements of ERCOT or NERC Operating Criteria, Guide, or Standard.

The generating facility licensed by a federal regulatory agency shall, through its QSE representative, provide any applicable grid interconnection and performance licensing requirements to ERCOT and the TDSP to which the licensee is connected.

The TDSP is obligated to incorporate any such licensing requirements into its planning and operations, and the ERCOT Control Area authority shall support such requirements. Both ERCOT and the TDSP will create necessary procedures for satisfying these requirements. Such procedures will include provisions to notify the facility licensee through its QSE of any requirements that cannot be satisfied.

Any proposal for revision of this Operating Guide and the procedures incorporating the licensee requirements that would diminish the obligation or ability of ERCOT or the TDSP to support these requirements shall be provided to the licensee through its QSE to afford it an opportunity for review and response. Any such proposal that is approved, as a result of which the licensee is required to implement changes to meet its license requirements or to seek amendment to its license, shall become effective no sooner than 6 months following the approval.



### 3.1.4.1 PGC Data Reporting

The PGC's reporting QSE shall provide the following information to ERCOT Control Area Authority at the times specified:

TIME	INFORMATION
Every ten (10) seconds	<ul style="list-style-type: none"> <li>➤ Generation net MW output,</li> <li>➤ Generation net MVAR,</li> <li>➤ Status of switching devices in switchyard,</li> <li>➤ Generating unit breaker status,</li> <li>➤ Generating unit High Operating Limit (HOL),</li> <li>➤ Generating unit Low Operating Limit (LOL).</li> </ul>
Daily	<ul style="list-style-type: none"> <li>➤ Planned unit status,</li> <li>➤ Planned unit capability (both hourly and daily),</li> <li>➤ Fuel limitations.</li> </ul> <p>The reporting Entity will promptly report this condition to ERCOT Control Area Authority.</p>
Annually	<ul style="list-style-type: none"> <li>➤ Seasonal capability where applicable,</li> <li>➤ Planned maintenance schedules.</li> </ul> <p>This information shall be updated when it changes.</p>
Upon request	<ul style="list-style-type: none"> <li>➤ Fuel capability as described in Section 6.2.7, Unit Alternative Fuel Capability, in conjunction with an Operating Condition Notice (OCN), Watch, Advisory, or Emergency Notice.</li> </ul>

Each generator at a generation Facility shall have its turbine's automatic speed governor in service when the generator is in normal operation. Testing and regulation performance of the speed governor shall be in accordance with Section 2.2.5, Turbine Speed Governors, of these Operating Guides. The generator operator is required to notify the ERCOT Control Area Authority, through its QSE, if the operation of speed governors is impaired.

Each generation Facility providing an Ancillary Service shall provide output consistent with the requirements of that Ancillary Service and ERCOT instructions.

In the event of an ERCOT declared emergency, ERCOT may require the QSE to notify the generation Facility through the reporting Entity and require it to increase or decrease generation or change voltage and reactive requirements in accordance with the Protocols. The generation Facility shall use its best efforts in meeting these required output levels in order that the ERCOT System can maintain safe and reliable operation.

It is the responsibility of all generators to carry an operational share of reactive support to insure adequate and safe Voltage Profiles are maintained in all areas of ERCOT. To accomplish this, the following requirements shall apply to each generation Facility.

- Each generation Facility shall have Automatic Voltage Regulators (AVRs) and power system stabilizers in service as defined in Section 3.1.4.5, Automatic Voltage Regulators and Power System Stabilizers, below.

- The generation Facility shall be designed and operated consistent with its Obligations to supply Voltage Support Service (VSS) as required in the ERCOT Protocols and ERCOT Control Area Authority Procedures.
- ERCOT has the right and obligation to Dispatch the reactive output (VARs) of each generation Facility within its design capability to maintain adequate transmission voltage in ERCOT.
- ERCOT and the Transmission Service Provider (TSP) shall be notified of any equipment changes that affect the reactive capability of an operating generating unit no less than sixty (60) days prior to implementation. Changes that decrease the reactive capability of the generating unit below the required level and changes that decrease the Voltage Ride-Through (VRT) capability of the plant must be approved by ERCOT prior to implementation. “Voltage Ride-Through” is defined as the ability of a generation plant to remain connected to the transmission system for specified high voltage and low voltage conditions.
- High reactive loading or reactive oscillations on generation units should be communicated to the QSE, the Transmission Operator (TO), and ERCOT as soon as practicable.
- The tripping Off-line of a generating unit due to voltage or reactive problems should be reported to ERCOT, the TO, and the QSE as soon as practicable.

**REFERENCE: PROTOCOL SECTION 6.10.2, GENERAL CAPACITY TESTING REQUIREMENTS**

*Within the first fifteen (15) days of each Season, each QSE shall provide ERCOT a seasonal High Sustainable Limit (HSL) for any Generation Resource with a capacity greater than ten (10) MW that will be operated during that Season. ERCOT shall provide an appropriate form for QSEs to submit their seasonal HSL data. The seasonal HSL shall take into account auxiliary Load and gross and net real power capability of the Generation Resource. Each QSE shall update its Resource Plan and telemetry, as necessary, to reflect the HSL of each of its Generation Resources in a given operating interval, as well as other operational limitations.*

*To verify that the HSL reported in the Resource Plan is achievable, ERCOT may, at its discretion, conduct an unannounced Generation Resource test. At a time determined solely by ERCOT, ERCOT will issue a verbal Dispatch Instruction to the QSE to operate the designated Generation Resource at its HSL as shown in the QSE’s Resource Plan at the time the test is initiated. The QSE shall not be required to start the designated Generation Resource if it is not already On-line when ERCOT announces its intent to test the Resource. If the designated Generation Resource is operating at its Low Sustainable Limit (LSL) when ERCOT sends the verbal Dispatch Instruction to begin the test, the QSE shall have up to sixty (60) minutes to allow the Resource to reach ninety percent (90%) of its HSL and up to an additional twenty (20) minutes for the Resource to reach the HSL shown in the Resource Plan at the time the test is initiated. This time requirement does not apply to nuclear-fueled Generation Resources. If the designated Generation Resource is operating between its LSL and fifty percent (50%) of its HSL when ERCOT begins the test, the QSE shall have sixty (60) minutes for the Resource to reach its HSL. If the Resource is operating at or above fifty percent (50%) of its HSL when ERCOT begins the test, the QSE shall have thirty (30) minutes for the Resource to reach its HSL. Once the designated Generation Resource reaches its HSL, the QSE shall hold it at that output level for a minimum of thirty (30) minutes. The HSL for the designated Generation Resource shall be*

*determined based on the Real Time averaged MW telemetered by the Resource during the thirty (30) minutes of constant output. After each test, QSEs will complete and submit an updated test form that ERCOT shall provide.*

*ERCOT may test multiple Generation Resources within a single QSE within a single twenty-four (24) hour period. However, in no case, shall ERCOT test more than two (2) Generation Resources within one (1) QSE simultaneously. All Resources On-line in an Aggregated Unit will be measured on an aggregate capacity basis. All QSEs associated with a jointly owned unit will be tested simultaneously. Hydro and wind generation will be excluded from unannounced generation capacity testing. ERCOT shall not perform an unannounced Generation Resource test during a Watch or Energy Emergency Alert (EEA) event. If an unannounced Generation Resource test is underway when a Watch or EEA event commences, ERCOT may cancel the test.*

*Should the designated Generation Resource fail to reach its HSL as posted in its Resource Plan within the time frame set forth herein, the Real Time averaged MW telemetered during the test shall be the basis for the new HSL for the designated Generation Resource for that Season. The QSE shall have the opportunity to request another test at a time determined by ERCOT and may retest as many times as desired. Subject to ERCOT approval, the requested retest will take place within the first twenty-four (24) Operating Hours of the designated Generation Resource after the request for retest or three (3) Business Days after the request for retest. Any verbal Dispatch Instruction ERCOT issues as a result of a QSE-requested retest will not be compensated under Section 6.8.2.3, Energy Payments, but will be considered as an instructed deviation for compliance purposes.*

*A Resource Entity owning a hydro unit operating in the synchronous condenser fast response mode to provide hydro Responsive Reserve shall evaluate the maximum capability of the Resource each Season.*

*ERCOT shall maintain historical records of unannounced Generation Resource test results, using the information contained therein to adjust the Reserve Discount Factor (RDF) subject to the approval of the appropriate Technical Advisory Committee (TAC) subcommittee. ERCOT shall report monthly the aggregated results of such unannounced testing (excluding retests), including, but not limited to, the number and total capacity of Resources tested, the percentage of Resources that met or exceeded their HSL reported in the Resource Plan, the percentage that failed to meet their HSL reported in the Resource Plan and the total MW capacity shortfall of those Resources that failed to meet their HSL reported in the Resource Plan.*

*ERCOT shall conduct all unannounced Generation Resource testing by using Out of Merit Energy (OOME) Dispatch Instructions to the Generation Resource under test. Any verbal Dispatch Instruction ERCOT issues as a result of a QSE-requested retest will not be compensated under Section 6.8.2.3 but will be considered as an instructed deviation for compliance purposes.*

*Load acting as a Resource (LaaR) to provide Ancillary Services shall have its telemetry attributes verified by ERCOT annually. In addition, once every two (2) years, any LaaR providing Responsive Reserve Service (RRS) shall test the under frequency relay or the output from the solid-state switch, whichever applies, for correct operation. However, if the Load's performance has been verified through response to an actual event, the data from the event can be used to meet the annual telemetry verification requirement for that year and/or the biennial relay testing requirement...*

### 3.1.4.2 Enforcement Of Unit Capability Testing Requirement

In the event that a QSE fails to meet the Protocol requirements requiring seasonal unit capability testing, ERCOT shall provide this QSE with notice of its failure to meet the Protocols. This notice shall be sent to the primary contact of the QSE representing the generating unit via both EMAIL and surface mail. In addition to this written notice ERCOT shall make a reasonable effort to notify the QSE via telephone.

ERCOT shall allow the QSE three (3) days to correct the omission by submitting the ERCOT approved test results as required by these guides<sup>1</sup>. If the generating unit in question is operated during these three days, and no test results are provided to ERCOT, then the QSE shall be disqualified from provision of Ancillary Services.

If the generating unit is not operated and included in a QSE Resource Plan after the notification of the protocols violation, then ERCOT shall not disqualify the A/S provider unless/until the unit is operated and included in a Resource Plan that might be depended upon for Ancillary Services.

### 3.1.4.3 Unit Reactive Capability Testing

**REFERENCE: PROTOCOL, SECTION 6.10.3.5, REACTIVE SUPPLY FROM GENERATION RESOURCES REQUIRED TO PROVIDE VSS**

- (1) *The Generation Entity must verify and maintain its stated Reactive Power capability for each of its Generation Resources required to provide VSS, as required by the Operating Guides. Generation Resources required to provide VSS reactive capability limits shall be specified considering nominal substation voltage.*
- (2) *The Generation Entity will conduct reactive capacity qualification tests to verify the maximum leading and lagging reactive capability of all Generation Resources required to provide VSS. Reactive capability tests will be performed on initial qualification and at a minimum of once every two years ERCOT may require additional testing if it has information indicating that current data is inaccurate. The Generation Entity is not obligated to place Generation Resources required to provide VSS On-line solely for testing. The reactive capability tests are run at a time agreed on in advance by the Generation Entity, its QSE, the applicable TDSP, and ERCOT.*
- (3) *Maximum lagging power factor reactive operating limit shall be demonstrated during peak Load Season, at or above ninety-five percent (95%) of the most currently tested net dependable megawatt capability, insofar as system voltage conditions and other factors will allow. The Generation Resource required to provide VSS should be required to maintain this level of Reactive Power for at least fifteen (15) minutes.*
- (4) *Maximum leading power factor reactive operating limit shall be demonstrated during light Load conditions, with the unit operating at a typical output for that condition, insofar as*

---

<sup>1</sup> Note that it is allowed by these guides and Protocols for the QSE to submit the maximum generation within a 168 hour period and submit without any special testing effort. A form is provided within these guides for submission of test results.

*system voltage conditions and other factors will allow. The unit should be required to maintain this level of Reactive Power for at least fifteen (15) minutes.*

- (5) *The Generation Entity shall perform the unit Automatic Voltage Regulator (AVR) tests and shall supply AVR data as specified in the Operating Guides. The AVR tests will be performed on initial qualification and periodically at an ERCOT-set interval no more often than once every five (5) years. The AVR tests are run at a time agreed on in advance by the Generation Entity, its QSE, the applicable TDSP, and ERCOT.*

#### **3.1.4.3.1 Corrected Unit Reactive Limits (CURL)**

The reactive capability curve for each unit on the ERCOT System shall be submitted to ERCOT containing the most limiting elements for the leading and lagging reactive output. The limiting factors such as under-excitation limiters, over-excitation limiters, ambient temperature limitations across the MW range of the unit at the unit terminals or any other factor that limits the reactive output of the unit and is verifiable through engineering calculations or testing may be produced on the corrected reactive capability curve. The corrected reactive capability curve establishes the CURL at the unit terminals that ERCOT Planning and ERCOT Operations will use for their studies. ERCOT Operations, after reviewing the updated curves and checking them for reasonableness, will forward copies to the Steady State Working Group, for use in modeling such capability in the ERCOT transmission planning cases. If ERCOT finds the submitted CURL unreasonable, ERCOT will follow the “ERCOT Implementation” section of this procedure. The reactive capability represented in the CURL will be used in operation and planning studies. For all intents and purposes this new curve would take the place of the original manufacturer’s unit reactive capability curve.

#### **3.1.4.3.2 Non-Coordinated Testing**

The QSE representing the generating unit shall give ERCOT at least two hours advance notice prior to the start of the test. ERCOT retains the right to cancel the reactive test if ERCOT believes, in its sole judgment, that conducting the test at the requested time could jeopardize the reliability of the ERCOT System. For example, ERCOT can cancel a requested leading capability test during a time when system voltages are low or expected to be low due to factors such as high import power levels, transmission line outages, capacitor bank outages, or generating unit outages or exciter limitations.

Tests to verify maximum lagging reactive capability shall be conducted during times when ERCOT System Loads are high, such as summer season afternoons when ambient temperatures exceed 90F, but not necessarily at the time of system peak. Units being tested shall be operating at or above 95% of net dependable real power (MW) output.

Tests to verify maximum leading reactive capability shall be conducted during times when ERCOT System Loads are low, such as off-peak hours during the spring season. Units being tested shall be operating at a real power (MW) output representative of its usual loading during such light Load periods.

The PGC shall measure the tested reactive capability at the generator terminals minus the auxiliary reactive consumption. Additionally, the tested reactive capability shall be measured at the high side of the generator step up transformer if metering is available. If metering is not available at the high side, the PGC shall calculate the reactive capability at the high side using the method specified in the appendix of the Biennial Unit Reactive Limits (Lead and Lag) Verification form located in Section 6.2.3, Biennial Unit Reactive Limits (Lead and Lag) Verification. Both high side and generator terminal values are required on the form for proper submittal of the test results.

The QSE representing a generating unit shall be responsible for scheduling reactive verification Tests in accordance with the conditions outlined above.

ERCOT shall have the option to waive the requirement to test and verify the maximum leading reactive capability of any generating unit that seldom runs during such light Load periods. The granting of such a waiver is at ERCOT's sole discretion, and any such waiver shall be effective for two years.

The minimum duration for any reactive verification test, leading or lagging, is fifteen minutes. The corrected curves ("CURL") should be posted in the PGC's control room, where the tests are conducted, at the QSE's Real Time/generation dispatch desk, and copies should be provided to ERCOT Operations. During any test, the unit must maintain its generator cooling system at normal operating level. Tests will be conducted to produce MVARs at a level not less than 90% of the amount indicated by the existing reactive capability curve (original manufacturer's unit reactive capability curve, or the most recent CURL).

The QSE representing a generating unit shall be responsible for the timely and accurate reporting of test results to ERCOT. The QSE representing a generating unit shall be responsible for the timely submittal to ERCOT of an updated CURL reflecting any known changes in the reactive output of the unit. All required data fields on the Biennial Unit Reactive Limits (Lead and Lag) Verification form must be properly completed for a valid test to be considered valid.

#### **3.1.4.3.3      *Coordinated Testing***

Coordinated Testing is the testing of a generator's reactive capability to verify the generating unit's most current CURL. The verification test will be a coordinated effort between the PGC, the PGC's QSE, the TO which the PGC is connected, and ERCOT Operations. Coordinated Testing is at the option of the PGC or can be ordered by ERCOT if a retest is required for an established non-valid test performed using the NCTP.

The PGC requesting to perform a coordinated test will provide ERCOT Operations Engineering Support and the TO with a minimum of 48 hours notice of the proposed test date. Requests shall be made weekdays between 8 AM to 5 PM excluding recognized ERCOT holidays. Upon receipt of a request for test, ERCOT Operations Engineering Support and the TO will evaluate the expected conditions and determine whether transmission system conditions conducive to a valid test can be created through coordinated network switching,

modification of the generation reactive Dispatch of nearby generating units, or by some other means. Having established that suitable transmission system conditions exist or can be created, ERCOT Operations Engineering Support and the TO shall provide the PGC and the QSE a concurrence of the test time and date or a rejection of the test time and date within 24 hours of the receipt of the request.

The coordinated test shall begin and end within the ERCOT Operations Engineer's standard work day (nominally 8 AM to 5 PM). Since leading tests will often occur in off-peak periods, the coordinated leading test shall begin and end at times agreed upon by ERCOT, the TO, QSE and PGC. The minimum duration for any reactive verification test, leading or lagging, is fifteen minutes. The corrected curves ("CURL") should be posted in the PGC's control room, where the tests are conducted, at the QSE's Real Time/generation Dispatch desk, and copies should be provided to ERCOT Operations. The testing period shall be scheduled such that adequate time is given for any transmission switching that may be performed to accommodate adequate system conditions for the appropriate reactive test. During the test, the QSE Operator shall be in communication with the TO in order to coordinate the reactive output of adjacent units, capacitor switching, reactor switching, and any other activity needed to perform the scheduled reactive test accurately.

#### LAGGING REACTIVE TESTS

Generating units shall be tested to verify lagging reactive capability at or above 95% of net dependable real power (MW) output as indicated on the CURL. It is during times when ERCOT System Loads are high and transmission system voltages are relatively low (such as summer season afternoons when ambient temperatures exceed 90F) that maximum lagging capability is most likely to be needed. The transmission voltage at the switchyard to which the generating unit is connected should be at or below the ERCOT currently scheduled voltage prior to starting the test. All efforts should be made to maintain the ERCOT Voltage Profile during the test, but this may be varied at ERCOT's discretion.

#### LEADING REACTIVE TESTS

Generating units shall be tested to verify leading reactive capability at a MW loading level representative of expected generating unit MW loading during minimum Load conditions as indicated on the CURL. It is during times when ERCOT System Loads are light and transmission system voltages are relatively high (such as off-peak hours during the spring season) that maximum leading capability is most likely to be needed. The transmission voltage at the switchyard to which the generating unit is connected should be at or above the ERCOT currently scheduled voltage prior to starting the test. All efforts should be made to maintain the ERCOT Voltage Profile during the test, but this may be varied at ERCOT's discretion. At ERCOT's sole discretion, the requirement to test leading capability may be waived for peaking generating units which seldom, if ever, run during light Load conditions.

The PGC shall measure the tested reactive capability at the generator terminals. The reading recorded shall represent the net MVAR output of the generator and shall have the unit's auxiliary reactive consumption deducted from the generator's gross reactive output at the machine's terminals. Additionally, the tested reactive capability shall be measured at the high

side of the generator step up transformer if metering is available. If metering is not available at the high side, the PGC shall calculate the reactive capability at the high side using the method specified in the appendix of the Biennial Unit Reactive Limits (Lead and Lag) Verification form located in Section 6.2.3, Biennial Unit Reactive Limits (Lead and Lag) Verification. Both high side and generator terminal values are required on the form for proper submittal of the test results.

The QSE representing a generating unit shall be responsible for scheduling reactive tests in accordance with the conditions outlined above, and for the timely and accurate reporting of test results to ERCOT. All test documents shall be submitted by the PGC's QSE. All required data fields on the Biennial Unit Reactive Limits (Lead and Lag) Verification form must be present for a valid test.

#### **3.1.4.3.4 *ERCOT Implementation***

Reactive test results shall be reviewed by ERCOT staff to determine the accuracy and consistency of the test data provided, and to determine the appropriateness of unit loading and system conditions during the test. In the event of significant discrepancies, ERCOT shall have the right to order a re-test of the unit.

Reactive test results shall be reviewed by ERCOT staff to determine if test results fall within 90% of CURL expectation. If test results are less than 90% of CURL expectation, ERCOT shall have the right to either order the PGC to produce a new CURL, or to order a re-test of the unit.

Reactive test results shall be reviewed by ERCOT staff against the most recent CURL for the unit. If unit reactive capability appears to be inappropriately limited by unit controls or relays, ERCOT staff shall contact the PGC and attempt to resolve the discrepancy. ERCOT shall have the right to order the PGC to produce a new CURL that reflects current operating limits.

CURL data validated by test, and any new CURL produced by a PGC in response to new operating limits, shall be implemented by ERCOT staff in its Operational Model within two weeks of receipt and resolution of the data. As soon as practicable thereafter, ERCOT staff will provide such data to the ERCOT Steady State Working Group for implementation in the planning model.

#### **3.1.4.3.5 *Enforcement of Unit Reactive Capability Testing***

Details of the enforcement for reactive capability testing can be found in the Compliance Template located on the ERCOT Compliance Web Page.

#### **3.1.4.4 Enforcement Of AVR Testing**

In the event that a QSE fails to meet the Protocol requirements requiring AVR testing, ERCOT shall provide this QSE with notice of its failure to meet the Protocols. This notice



shall be sent to the primary contact of the QSE representing the generating unit via both EMAIL and surface mail. In addition to this written notice ERCOT shall make a reasonable effort to notify the QSE via telephone. ERCOT shall also provide notice directly to the primary contact for the Generation Resource Entity.

If a satisfactory reply, as determined by ERCOT, is not received from the Generation Entity, or its QSE within 30 days of their receipt of written notification, ERCOT shall notify the PUC Market Oversight Division of the Generation Resource Entity's failure to comply with the Protocols.

#### **3.1.4.5 Automatic Voltage Regulators and Power System Stabilizers**

Generator Automatic Voltage Regulators and power system stabilizers will be kept in service whenever possible. Generation Entities shall notify their QSE, who in turn will promptly notify the ERCOT Control Area Authority by telephone of the circumstances, when a voltage regulator or stabilizer is unavailable due to maintenance or failure and when it is returned to normal operation.

Unit AVR and PSS modeling information required in the ERCOT Planning Criteria shall be determined from actual unit testing described in the Operating Guides. Within thirty (30) days of ERCOT's request, the results of the latest test performed shall be supplied to ERCOT and the TSP.

#### **3.1.4.6 Protective Relaying and Voltage Ride-Through (VRT) Requirement**

The Facility's generation machine characteristics and plant design shall incorporate the under-frequency firm Load shedding philosophy and criteria defined in Operating Guide 2.9, Requirements for Under-Frequency Relaying. Inherent in this philosophy is the idea that all generators remain on line until all three steps of firm Load shedding have been executed. In addition, Generation Resources must set generator voltage relays to remain connected to the transmission system during the following operating conditions:

- Generator terminal voltages are within five percent (5%) of the rated design voltage and volts per hertz are less than one hundred five percent (105%) of generator rated design voltage and frequency;
- Generator terminal voltage deviations exceed five percent (5%) but are within ten percent (10%) of the rated design voltage and persist for less than 10.0 seconds;
- Generator volts per hertz conditions are less than one hundred sixteen percent (116%) of generator rated design voltage and frequency and last for less than 1.5 seconds;
- A transmission system fault (three-phase, single-phase or phase-to-phase), but not a generator bus fault, is cleared by the protection scheme coordinated between the Generation Entity and the TDSP on any line connected to the generator's transmission interconnect bus, provided such lines are not connected to induction generators described in item (7), Protocol Section 6.5.7.1, Generation Resources Required to Provide VSS Installed Reactive Capability. However, in the case of a generator bus fault or a primary transmission system relay failure, the generator protective relaying may clear the generator independent of the operation of any transmission protective relaying.

The generation Facility shall have protective relaying necessary to protect its equipment from abnormal conditions as well as to be consistent with protective relaying criteria as described in Section 7.2, System Protective Relaying.

Within thirty (30) days of ERCOT's request, Generation Resources shall provide ERCOT with the operating characteristics of any generating unit's equipment protective relay system or controls that may respond to temporary excursions in voltage with actions that could lead to tripping of the generating unit.

Generating Resources required to provide VSS shall have and maintain the following capability:

- (1) Over-excitation limiters shall be provided and coordinated with the thermal capability of the generator field winding and protective relays in order to permit short-term reactive capability that allows at least eighty percent (80%) of the unit design standard (ANSI C50.13-1989), as follows:

Time (seconds)	10	30	60	120
Field Voltage %	208	146	125	112

After allowing temporary field current overload, the limiter shall operate through the automatic AC voltage regulator to reduce field current to the continuous rating. Return to normal AC voltage regulation after current reduction shall be automatic. The over-excitation limiter shall be coordinated with the over-excitation protection so that over-excitation protection only operates for failure of the voltage regulator/limiter.

- (2) Under-excitation limiters shall be provided and coordinated with loss-of-field protection to eliminate unnecessary generating unit disconnection as a result of operator error or equipment misoperation.

#### **3.1.4.6.1 Protective Relaying Requirement and Voltage Ride-Through Requirement for Wind-powered Generation Resources**

- Wind-powered Generation Resources (WGRs) specified below are required to set generator voltage relays to remain in-service during all transmission faults (no more than nine (9) cycles) in accordance with Figure 1, Voltage Ride-Through Boundaries For Wind-powered Generation Resources, below. Faults on individual phases with delayed clearing (zone 2) may result in phase voltages outside this boundary but if the phase voltages remain inside this boundary then generator voltage relays are required to be set to remain connected and recover within the voltage recovery boundary of Figure 1.
- WGR voltage relays shall be set to remain interconnected during three-phase faults on the transmission system for a voltage level as low as zero volts with a duration no more than nine (9) cycles as measured at the point of interconnection as shown in Figure 1. The clearing time requirement for a three-phase fault will be specific to the generating plant point of interconnection, as determined by and documented by the transmission provider in conjunction with the interconnection agreement. This requirement does not apply to faults that would occur between the generator terminals

and the transmission voltage side of the generation step-up transformer or when clearing the fault effectively disconnects the generator from the system.

- WGRs may be tripped after the fault period if this action is intended as part of a Special Protection System (SPS).
- WGRs may meet the VRT requirements of Figure 1 by the performance of the generators or by installing additional equipment (e.g., Static VAR Compensator) within the generating plant or by a combination of generator performance and additional equipment.
- WGRs that have had over 50 seconds cumulative operation over the life of the WGR below 10% of nominal voltage at the point of interconnection shall be allowed, with ERCOT's approval, to set generator voltage relays to provide sufficient protection to the WGR to comply with warranty requirements and to retain the expected life of the resource.
- Existing individual WGRs that are replaced are required to meet the requirements of Figure 1.
- WGRs that are part of a Generation Interconnect Agreement signed after November 1, 2008 shall meet the requirements of Section 3.1.4.6.1, Protective Relaying Requirement and Voltage Ride-Through Requirement for Wind-powered Generation Resources. All such WGRs shall provide a status of compliance to ERCOT System Planning by July 1, 2009.
- WGRs that are part of a Generation Interconnect Agreement signed prior to November 1, 2008 shall provide information requested by ERCOT, including existing WGR VRT capabilities, for a study to evaluate the need for additional protective relaying and VRT requirements applicable to some or all such WGRs. The study will be conducted using the 2009-2010 transmission system as determined by ERCOT. The study shall be conducted by a qualified organization having no real or apparent bias and with no financial interest in the outcome of the study. ERCOT shall publish study results and provide recommendations to ROS no later than the scheduled ROS meeting of June 2010. If the results of the study demonstrate the need, this Operating Guide shall be revised on an expedited basis to establish those requirements. Those WGRs requiring retrofit to meet a revised Operating Guide shall install the required retrofits within eighteen (18) months after the effective date of the revised Operating Guide.
- Notwithstanding any of the foregoing provisions, existing individual WGRs that meet the requirements of Figure 1 on November 1, 2008 shall continue to meet the requirements of Figure 1.
- If, due to a system disturbance, a WGR comes Off-line within the boundaries of the VRT requirement of Figure 1, then the WGR owner and the TSP shall be required to investigate and report to ERCOT on the cause of the WGR trip identifying a reasonable mitigation plan and timeline.

ERCOT and the TSP shall be notified of any equipment changes that affect the reactive capability of an operating WGR no less than sixty (60) days prior to implementation of the changes, and any such changes that decrease the reactive capability of the WGR below the required level and changes that decrease the VRT capability of the plant must be approved by ERCOT prior to implementation.

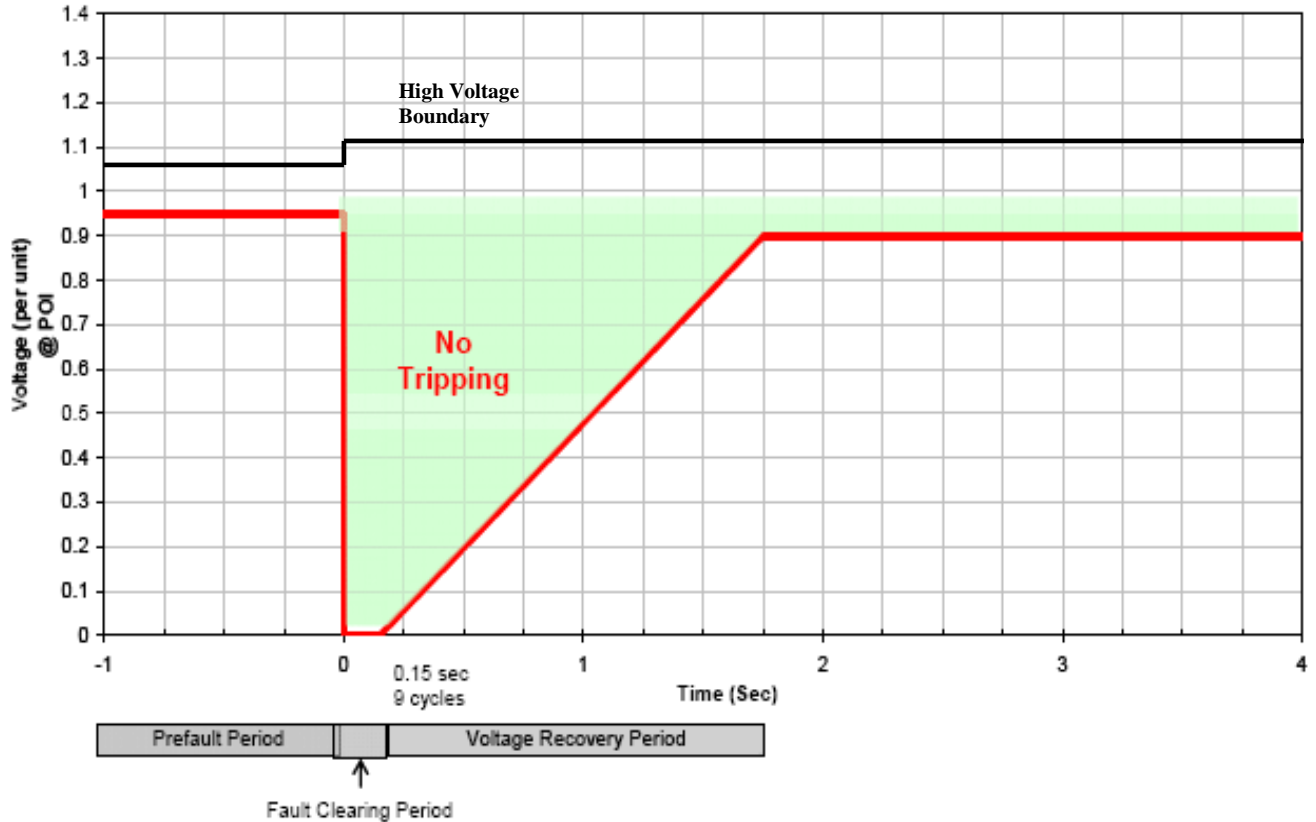

Figure 1: Voltage Ride-Through Boundaries For Wind-powered Generation Resources

### 3.1.4.7 Outages

#### *Forced Outages*

The Control Area Authority shall be advised via telemetry of all Forced Outages of ANY Resource capability within one minute.

#### *Sabotage Information Exchange*

A PGC or any ERCOT Entity shall inform the ERCOT operator when:

- It is suspected or identified that multi-site sabotage has occurred
- It is suspected or identified that a single-site sabotage of a critical facility has occurred

### 3.1.4.8 Enforcement of Load acting as a Resource (LaaR) Testing Requirement

After initial qualification, a LaaR's telemetry and any applicable relay functionality will be tested and validated by ERCOT within twenty-four (24) months as specified in these Operating Guides. If a LaaR fails to provide the appropriate documents as required in the annual and biennial verification test for two (2) consecutive years, ERCOT shall notify the associated QSE of any noncompliance. After a thirty (30) day allowance for the deficiency to

be corrected, ERCOT shall reduce the Resource's ability to provide Ancillary Services in the ERCOT market to zero.

### **3.1.5 Transmission and/or Distribution Service Providers**

**REFERENCE: PROTOCOL SECTION 5.5.2, CHANGES IN TRANSMISSION FACILITY STATUS**

*The TDSP will notify ERCOT of any changes in status of Transmission Facility elements as provided and clarified in the ERCOT procedures. The TDSP will notify ERCOT of any other Transmission Facility status as soon as practicable following the change. In addition, any short-term inability to meet minimum TSP or DSP reactive requirements shall be immediately reported to ERCOT by way of the TSP.*

**REFERENCE: PROTOCOL SECTION 6.4.2, DETERMINATION OF ERCOT CONTROL AREA REQUIREMENTS (IN PART)**

...(6) *Voltage Support: ERCOT in coordination with the TDSPs shall conduct studies to determine the normally desired Voltage Profile for all Voltage Support busses in the ERCOT System and shall post all Voltage Profiles on the Market Information System. ERCOT may temporarily modify its requirements based on Current System Conditions. ERCOT shall determine the amount of Voltage Support Service needed to provide sufficient reactive capacity in appropriate locations to provide ERCOT System security as specified in the Operating Guides...*

**REFERENCE: PROTOCOL 6.5.7.1, GENERATION RESOURCES REQUIRED TO PROVIDE VSS INSTALLED REACTIVE CAPABILITY (IN PART)**

- (1) *Generation Resources required to provide VSS must be capable of producing a defined quantity of Reactive Power at rated capability (MW) to maintain a Voltage Profile established by ERCOT. This quantity of Reactive Power is the Unit Reactive Limit (URL).*
- (2) *Generation Resources required to provide VSS except as noted below in items (3) or (4), shall have and maintain a URL which has an over-excited (lagging) power factor capability of ninety-five hundredths (0.95) or less and an under-excited (leading) power factor capability of ninety-five hundredths (0.95) or less, both determined at the generating unit's maximum net power to be supplied to the transmission grid and at the transmission system Voltage Profile established by ERCOT, and both measured at the point of interconnection to the TDSP...*

**REFERENCE: PROTOCOL 6.5.7.2, QSE RESPONSIBILITIES (IN PART)**

- (1) *QSE Generation Resources required to provide VSS are expected to have and maintain Reactive Power capability at least equal to the Reactive Power capability requirements specified in these Protocols and the Operating Guides...*

...(5) *QSEs shall meet, within established tolerances, and respond to changes in the Voltage Profile established by ERCOT subject to the stated QSE Reactive Power and actual power operating characteristic limits and voltage limits...*

**REFERENCE: PROTOCOL SECTION 6.5.7.3, ERCOT RESPONSIBILITIES (IN PART)**

- (1) *ERCOT, in coordination with the TDSPs, shall establish, and update as necessary, Voltage Profiles at points of interconnection of Generation Resources required to provide VSS to maintain system voltages within established limits...*
- ...(3) *ERCOT, in coordination with the TDSPs, shall deploy static Reactive Power Resources as required to continuously maintain dynamic Reactive Reserves from QSEs, both leading and lagging, adequate to meet ERCOT System requirements...*

**REFERENCE: PROTOCOL SECTION 6.7.6, DEPLOYMENT OF VOLTAGE SUPPORT SERVICE (IN PART)**

- ...(2) *ERCOT and TDSPs shall develop operating procedures specifying Voltage Profiles of transmission controlled reactive Resources to minimize the dependence on generation-supplied reactive Resources. For Generation Resources required to provide VSS, step-up transformer tap settings will be managed to maximize the use of the ERCOT System for all Market Participants while maintaining adequate reliability...*

ERCOT and TDSPs shall operate the ERCOT Interconnected System in compliance with Good Utility Practice and NERC and ERCOT standards, policies, guidelines and operating procedures.

TDSPs monitoring system conditions shall notify ERCOT when Transmission Facility Elements reach safe operating limits as soon as practicable, if these Transmission Facility Elements will affect the ERCOT system.

A TDSP shall notify ERCOT Control Area Authority of any changes in their transmission facility status within 10 seconds of the change of status.

TDSPs shall follow ERCOT instructions related to ERCOT responsibilities:

- Performing the physical operation of the ERCOT Transmission Grid, including circuit breakers, switches, voltage control equipment, protective relays, metering and load shedding equipment;
- Directing changes in the operation of transmission voltage control equipment;
- TDSPs will maintain voltage set points established by ERCOT utilizing static reactive devices. TDSPs, under the direction of ERCOT, will coordinate TDSP static device switching with QSE dynamic reactive device operation. Static reactive devices will be brought on line before predicted daily maximum load growth or dynamic reactive resources reach operating limits. Static reactive devices will be taken off line during daily load decline and before dynamic reactive resources reach operating limits. ERCOT will coordinate Automatic Voltage Regulator, dynamic and static reactive device outages to ensure adequate reactive reserves are maintained
- Taking those additional actions required to prevent an imminent Emergency Condition or to restore the ERCOT Transmission Grid to a secure state in the event of an ERCOT System Emergency.

Each TDSP, at its own expense, may obtain Operating Period data from ERCOT (See Section 2.3.1, Control Area Operator Authority).

### **3.1.5.1 Transmission Operator Responsibility for Department of Energy (DOE) and NERC Reportable Events**

TOs shall provide ERCOT with the DOE Form OE-417 report for each DOE reportable event that happens in areas they represent. ERCOT, as the Control Area Authority, will forward these reports to the DOE and NERC as required.

### **3.1.5.2 Transmission Owner Responsibility for a Vegetation Management Program.**

Each transmission owner shall have a Vegetation Management Program outlining procedures to prevent transmission line contact with vegetation. The transmission owner shall maintain documentation to verify the performance of the Vegetation Management Program and shall provide that documentation to their respective Transmission Operator and ERCOT upon request.

Details of the NERC requirements can be found in the Vegetation Management Program Template located on the ERCOT Compliance Web Page.

### **3.1.5.3 Outages**

#### **3.1.5.3.1 *NERC Requirements for Reporting Vegetation-Related Line Outages***

In ERCOT, transmission owners shall report vegetation-related 345 kV transmission line outages for each calendar month to their respective Transmission Operator. Transmission Operators shall report these monthly Outage statistics to ERCOT Compliance by the 20th of the following month. ERCOT Compliance shall report results to NERC.

Details of the NERC requirements, including reporting exceptions, can be found in the Vegetation Management Program Template located on the ERCOT Compliance Web Page.

#### **3.1.5.3.2 *ERCOT Requirements for Reporting Forced Outages***

Forced outages of all transmission lines (>60 kV) shall be reported to ERCOT Control Area Authority immediately.

Forced outages of other transmission equipment that affect power flows or transfer capacity will be reported immediately to ERCOT Control Area Authority.

When a forced outage affects the overall security or capacity, ERCOT shall take remedial steps immediately to insure that other facilities are not loaded beyond capacity limits.

An Outage initiated by protective relay, or manually in response to an observation by field personnel or the TDSP System Operator that equipment poses a threat to personnel or equipment. The TDSP may remove such equipment from service immediately and notify ERCOT of its action.

### 3.1.5.3.3 *ERCOT Requirements for Reporting Scheduled Outages*

When a transmission line (>60 kV) is out of service the capacity of ERCOT transmission lines should not be exceeded under normal or single contingency conditions.

TDSPs shall communicate the information to the Distribution Service Providers connected to that TDSP.

### 3.1.5.3.4 *ERCOT Requirements for Reporting Sabotage Information*

A TDSP or any ERCOT entity shall inform the ERCOT operator when:

- It is suspected or identified that multi-site sabotage has occurred.
- It is suspected or identified that a single-site sabotage of a critical facility has occurred.
- Occurred.

### 3.1.6 Responsibility For Equipment Ratings

TDSPs are responsible for determining the rating of their facilities.

Technical limits established for the operation of transmission equipment shall be applied consistently in TTC calculations, engineering studies, real-time security analyses, and operator actions.

TDSP's shall provide ERCOT with three (3) nominal Transmission Facility Ratings:

- **Continuous Rating:** Represents the continuous MVA rating of a Transmission Facility (including substation terminal equipment in series with a conductor or transformer) at the applicable ambient temperature. The Transmission Facility can operate at this rating indefinitely without damage, or violation of National Electrical Safety Code (NESC) clearances.
- **Emergency Rating:** Represents the two (2) hour MVA rating of a Transmission Facility (including substation terminal equipment in series with a conductor or transformer) at the applicable ambient temperature. The Transmission Facility can operate at this rating for two (2) hours without violation of NESC clearances or equipment failure.
- **Fifteen Minute Rating:** Represents the fifteen (15) minute MVA rating of a Transmission Facility (including substation terminal equipment in series with a conductor or transformer) at the applicable ambient temperature and with a step increase from a prior loading of ninety percent (90%) of the Continuous Rating. The Transmission Facility can operate at this rating for fifteen (15) minutes, assuming its pre-contingency loading was ninety percent (90%) of the Continuous Rating limit at the applicable ambient temperature, without violation of NESC clearances or equipment failure. This rating takes advantage of the time delay associated with heating of a conductor or transformer following a sudden increase in current.

In operating the Transmission Grid, ERCOT shall use these ratings as follows:

- ERCOT shall limit pre-contingency flows to enforce the Continuous Rating.



- If a valid Remedial Action Plan is unavailable to unload the Transmission Facility post contingency or the pre-contingency loading is greater than ninety percent (90%) of the Continuous Rating, ERCOT shall enforce pre-contingency System Operating Limit(s) to control the post contingency loading of the facility to levels below the Emergency Rating. The enforcement shall be implemented in a manner such that the post contingency loading will be at, or below, Continuous Rating within two (2) hours.
- If a Remedial Action Plan is documented at ERCOT to relieve the loading on the Transmission Facility within fifteen (15) minutes; ERCOT shall enforce pre-contingency System Operating Limit(s) to control the post contingency loading of the facility to levels below the Fifteen Minute Rating. The enforcement shall be implemented in a manner such that the post contingency loading will be at, or below, Emergency Rating within fifteen (15) minutes.
- ERCOT shall use best efforts to restore all Transmission Facilities to within Continuous Ratings as soon as practicable, based on Good Utility Practice.

## 3.2 Scheduling Interfaces with ERCOT

### 3.2.1 Scheduling-Related Duties of Qualified Scheduling Entities

#### 3.2.1.1 Functions and Activities

QSEs must submit schedules that identify Obligations and Supply. QSEs must submit Balanced Schedules for each Settlement Interval. For a Schedule to be balanced total Energy Obligation must equal total Energy Supply and total Ancillary Services Obligation for each service type must meet total Ancillary Services Supply for each service type.

It is necessary to balance Ancillary Services schedules, as well as, Energy Schedules. In order to do so, the QSE must indicate on its schedule the amount of Ancillary Services that will be purchased from the ERCOT Ancillary Services Market.

#### 3.2.1.2 Schedule Components

**REFERENCE: *PROTOCOL SECTION 4.3.2, Schedule Components***

*Included in each Balanced Schedule is:*

- (1) *Energy to be produced by Resources that the QSE represents, by Congestion Zone;*
- (2) *Energy to be consumed by Loads that the QSE represents (including T&D Losses) by Congestion Zone;*
- (3) *ERCOT allocated Ancillary Services Obligations for the QSE;*
- (4) *Any energy and Ancillary Services scheduled to or from other QSEs (e.g. Inter-QSE Trades);*

- (5) *Any Balancing Energy scheduled through the ERCOT Scheduling Process; and*
- (6) *Any Self-Arranged Ancillary Services.*

*When relaxed Balanced Schedules are allowed by ERCOT, pursuant to Section 4.3.5, Requirement for Balanced Schedules, the requirement for subpart (2) above shall be relaxed and QSEs shall be allowed to schedule energy for Load that is equivalent to the amount of scheduled energy for Resources as specified in subpart (1) and (5) above.*

*Use of Balancing Energy scheduled via ERCOT to meet Obligations shall be limited to an amount supported by the QSE's credit collateral with ERCOT.*

### **3.2.1.3 Special Scheduling Considerations for Split Generation Meters**

#### **REFERENCE: PROTOCOL SECTION 4.3.3, SPECIAL SCHEDULING CONSIDERATIONS FOR SPLIT GENERATION METERS**

*When a generation meter is split, as provided for in Section 10, Metering, two or more independent virtual generating units may be created for purposes of scheduling, ERCOT System operation, and settlement.*

*Each virtual generator unit may be scheduled by a different QSE. A QSE may only schedule up to the fixed ownership percentage of the actual generator's maximum output.*

*Each QSE will be responsible for including the virtual generator portion in its Resource Plan. A QSE's Ancillary Services capacity will be bid for the jointly-owned unit on the basis of a fixed ownership percentage that is shown in the registration database.*

*ERCOT will handle scheduling discrepancies in the same manner as other units.*

When a generation meter is split, as provided for in the Protocols, Section 10, Metering, two or more independent virtual generating units may be created for purposes of scheduling, ERCOT System operation, and settlement.

Each virtual generator unit may be scheduled by a different QSE. A QSE may only schedule up to the fixed ownership percentage of the actual generator's maximum output.

Each QSE will be responsible for including the virtual generator portion in its Resource Plan.

A QSE's Ancillary Services capacity will be bid for the jointly owned unit on the basis of a fixed ownership percentage that is shown in the registration database.

ERCOT will handle scheduling discrepancies in the same manner as other units.

### 3.2.1.4 Operations of the Qualified Scheduling Entity

**REFERENCE: PROTOCOL SECTION 4.3.4, OPERATIONS OF THE QUALIFIED SCHEDULING ENTITY**

*Scheduling Center Requirement. A QSE shall maintain a 24-hour, seven-day-per-week scheduling center with qualified personnel for the purposes of communicating with ERCOT for scheduling purposes and for deploying the QSE's Ancillary Services in Real Time.*

*QSE Representative. Each QSE shall, for the duration of the Scheduling Process and settlement period for which the QSE has submitted schedules to ERCOT, designate a representative who shall be responsible for operational communications and who shall have sufficient authority to commit and bind the QSE.*

A QSE shall maintain a 24-hour, seven-day-per-week scheduling center with qualified personnel for the purposes of communicating with ERCOT for scheduling purposes and for deploying the QSE's Ancillary Services in Real Time.

Each QSE shall, for the duration of the scheduling process and settlement period for which the QSE has submitted schedules to ERCOT, designate a representative who shall be responsible for operational communications and who shall have sufficient authority to commit and bind the QSE.

### 3.2.1.5 Requirement for Balanced Schedules

**REFERENCE: PROTOCOL SECTION 4.3.5, REQUIREMENT FOR BALANCED SCHEDULES (IN PART)**

*A QSE shall submit to ERCOT only Balanced Schedules, for both energy and Ancillary Services, in the Day Ahead Scheduling Process and the Adjustment Period. If a QSE submits a schedule that is not a Balanced Schedule, ERCOT shall reject that schedule in accordance with Section 4.4.13, ERCOT Day Ahead Ancillary Services Procurement Process...*

A QSE shall submit to ERCOT only Balanced Schedules, for both energy and Ancillary Services, in the Day Ahead Scheduling Process and the Adjustment Period. If a QSE submits a schedule that is not a Balanced Schedule, ERCOT shall reject that schedule.

## 3.2.2 Scheduling Process

### 3.2.2.1 Day Ahead Scheduling

**REFERENCE: Extracted from Protocol Section 4.1.1 and Operating Guides Section 2.5.1**

DAY AHEAD TIME PERIOD	QUALIFIED SCHEDULING ENTITY (QSE) SUBMISSION:
1100	<ul style="list-style-type: none"> <li>➤ Balanced Energy Schedule of Obligations and Resources</li> <li>➤ Self-Arranged AS Schedule</li> </ul>

<b>DAY AHEAD TIME PERIOD</b>	<b>QUALIFIED SCHEDULING ENTITY (QSE) SUBMISSION:</b>
1115	➤ Resubmit corrected schedules
1300	<ul style="list-style-type: none"> <li>➤ Update Balanced Energy Schedule of Obligations and Resources</li> <li>➤ Update Self-Arranged AS schedule</li> <li>➤ AS bids to supply AS to ERCOT AS Market</li> </ul>
1315	➤ Resubmit corrected updated schedules.
1500	➤ Submit updated AS schedule that includes Self-Arranged and AS bids selected by ERCOT.
1600	<ul style="list-style-type: none"> <li>➤ Submit Resource Plans with unit-specific information</li> <li>➤ Submit Replacement Reserve Service (RPRS) Bids and associated Balancing Energy bids.</li> </ul>
After 1800	➤ Modify RPRS bids

### 3.2.2.2 Adjustment Period Scheduling

**REFERENCE: PROTOCOL SECTION 4.1.2, ADJUSTMENT PERIOD SCHEDULING PROCESS (IN PART)**

*The Adjustment Period (AP) Scheduling Process will follow the following timeline with time T being the start of the Operating Hour:*

<b>Adjustment Period</b>	<b>QSE Responsibility:</b>	<b>ERCOT Responsibility:</b>
<i>Time = T minus 60 minutes</i>	<ul style="list-style-type: none"> <li>• <i>Submit updated Balanced Schedule of Obligations and Supply for the hour beginning at Time T, and any hour after T.</i></li> <li>• <i>Submit bids for Balancing Energy including any mandatory decremental Balancing Energy bids and any mandatory Balancing Energy bids for Non-Spin obligations.</i></li> <li>• <i>Submit updated Self-Arranged AS schedule for the hour beginning at Time T and any hour after Time T (the amount of Self-Arranged AS may not change from Day Ahead, however, the Resources supplying the Self-Arranged AS may be altered. If ERCOT calls on additional AS in the AP, the allocated portion of the additional AS may be self-arranged).</i></li> <li>• <i>Submit updates to Resource Plan.</i></li> <li>• <i>Submit bids for RPRS.</i></li> <li>• <i>Submit bids for additional Ancillary Services.</i></li> </ul>	<ul style="list-style-type: none"> <li>• <i>Review updated Balanced Schedule.</i></li> <li>• <i>Review updated Resource Plans.</i></li> <li>• <i>Review updated Self-Arranged AS schedule.</i></li> <li>• <i>Validate schedules and notify affected QSEs of any invalid or mismatched schedules.</i></li> <li>• <i>Identify CSC Congestion or OC or capacity insufficiency.</i></li> </ul>

	<ul style="list-style-type: none"> <li>Submit bids for incremental and decremental Resource specific premiums.</li> </ul>	
Time = T minus 45 minutes	<ul style="list-style-type: none"> <li>Resubmit corrected schedules.</li> </ul>	

### 3.2.3 Procurement of Replacement Reserve Service Resources

The typical RPRS procurement process will adhere to the following timeline:

RPRS PROCUREMENT PROCESS	QSE RESPONSIBILITY
Time X	Submit or update bids for RPRS
Time X plus 60 minutes	Update Balanced Schedules
Time X plus 75 minutes	Resubmit corrected schedules.

Time X is the start of a clock hour when ERCOT identifies Zonal and Local Congestion, or capacity insufficiency.

Time X can be the start of any clock hour during the Adjustment Period but cannot be less than 2 hours prior to the Operating Hour that energy from the RPRS unit is required.

RPRS bids remain active until withdrawn by the QSE.

### 3.2.4 Procurement of Additional Ancillary Services

The Adjustment Period AS procurement process for RRS, NSRS and RGS will use the following timeline with time X being the start of a clock hour when ERCOT identifies the need for additional AS. Time X can be the start of any clock hour during the Adjustment Period but cannot be less than 2 hours prior to the Operating Hour that the additional AS capacity is required.

ADDITIONAL AS PROCUREMENT PROCESS	QSE RESPONSIBILITY
Time X	Submit or update bids for RRS, NSRS and RGS
Time X plus 60 minutes	Update their Balanced Schedules, including additional Self-Arranged AS.  Remove the portion of the bid, submitted by Time X, that are to be used in incremental self-arrangement and bilateral AS sales, if desired.
Time X plus 75 minutes	Resubmit corrected schedules.

### 3.2.5 Direct Current Tie Interconnection Day Ahead Scheduling Process

**REFERENCE: PROTOCOL SECTION 4.4.18.4, SETTLEMENT (IN PART)**

*A QSE exporting from ERCOT through a DC Tie export schedule will include that DC Tie export schedule as an Obligation in its Balanced Schedule by using the identifier field indicating the appropriate DC Tie. Exports from ERCOT via DC Ties will be treated as a Load connected at transmission voltage in the settlement system and are responsible for allocated Ancillary Services, Transmission Losses, UFE, ERCOT administrative fees, as described in Section 9, Settlement and Billing, and any other applicable ERCOT fees...*

A QSE exporting from ERCOT through a DC Tie export schedule will include that DC Tie export schedule as an Obligation in its Balanced Schedule.

A QSE importing into ERCOT through a DC Tie import schedule will include that DC Tie import schedule as a Supply in its Balanced Schedule.

### 3.2.6 Dynamic Schedules

**REFERENCE: PROTOCOL SECTION 4.9.1, DYNAMIC LOAD SCHEDULES**

*QSE's may use dynamic power signals to control generation to match a metered Load in order to minimize the QSE's exposure to the Balancing Energy market. To implement the Dynamic Schedule the QSE will send Real Time telemetry to ERCOT that is equal to the metered Load, which the QSE wishes to follow. ERCOT will integrate the signal for each Settlement Interval and provide the integrated signal to settlement as the scheduled Obligation for that metered Load. Settlement will use this integrated value as a scheduled Supply for that interval for the QSE. At settlement the integrated values will be used as a Supply or Obligation schedule.*

*The QSE's schedule will include one Supply Resource (or fleet) designated to follow the Dynamic Schedule for a Load. The designated Supply schedule will be estimated in the same manner as the designated Load. At settlement, the estimated schedule for the designated Resource will be replaced with the integrated final power signal from the dynamic Load.*

**REFERENCE: PROTOCOL SECTION 4.9.2, APPROVAL OF THE USE OF DYNAMIC LOAD SCHEDULES**

- (1) *Each QSE desiring to use Dynamic Load Schedules must submit a proposal of the Dynamic Schedule to ERCOT for analysis of Congestion impacts and reliability in accordance with the Operating Guides.*
- (2) *Subject to number (1) above, any QSE representing Non Opt-In Entities that own, had under construction, or had contractual rights to Generation Resources, as of May 1, 2000, may use Dynamic Schedules. Once a Non Opt-In Entity (NOIE) offers Customer Choice, it must submit a new proposal for Dynamic Load Scheduling to ERCOT.*
- (3) *ERCOT will approve dynamic scheduling proposals on a case-by-case basis. Approval will be based on the schedule's impact on ERCOT's ability to determine and manage Congestion,*

*ERCOT's ability to monitor Generation Resource and Load behavior associated with the schedule and the schedule's impact on system reliability. QSEs representing Non Opt-In Entities, which submit proposals in accordance with (1) and (2) above will be accepted by ERCOT.*

- (4) *New proposals for Dynamic Load Schedules within Congestion Zones will be considered after June 1, 2001 and across Congestion Zones after June 1, 2002.*

**REFERENCE: PROTOCOL SECTION 4.9.3, PRINCIPLES FOR DYNAMIC SCHEDULES**

- (1) *All power signals for Dynamic Schedules must be sent to ERCOT in Real Time via telemetry.*
- (2) *Each Dynamic Load Schedule must be tied to a Load meter or group of Load meters. This includes Load that is calculated by subtracting interchange telemetry from actual generation telemetry, appropriately adjusted for T&D Losses. A Load or group of Loads that is/are dynamically scheduled can only be followed by Generation Resources represented by the same QSE as the Load.*
- (3) *Each Dynamic Load Schedule will indicate the dynamic power signal that will be used to create the final schedule.*
- (4) *Dynamic Load Schedules tied to Load meters (or groups of Load meters) may be used between Congestion Zones.*
- (5) *A QSE using Dynamic Load Schedules shall send a dynamic power signal or signals to ERCOT.*
- (6) *Each QSE with a Dynamic Load Schedule will include in its schedules and plans submitted to ERCOT, an estimate for the integration of the schedule for each Settlement Interval. These schedule integration estimates will be used for allocation of RPRS costs.*
- (7) *ERCOT will integrate the dynamic power signal sent by a QSE for each Settlement Interval. This integrated signal shall replace the estimate and will be used in settlement as the final schedule. Dynamic Schedules do not alter the settlement process for metered Loads.*
- (8) *If a signal is lost for any reason, ERCOT will use the final schedule for Settlement purposes.*
- (9) *ERCOT will use the dynamic power signal in each of the applicable QSE's SCE equation.*

**3.2.7 Approval of the Use of Responsibility Transfer (RspT) Schedules**

**REFERENCE: PROTOCOL SECTION 4.9.4.1, APPROVAL OF THE USE OF RESPONSIBILITY TRANSFERS**

- (1) *Intra-zonal Responsibility Transfers (RspTs) will be approved unless ERCOT determines it cannot accommodate these transfers without compromising reliability or settlement accuracy.*
- (2) *Each QSE that proposes to use an RspT must submit a proposal of the RspT to ERCOT for analysis of Congestion impacts and reliability in accordance with the Operating Guides. The proposal for each RspT shall identify:*

- (a) *Controlling Entity;*
- (b) *Following Entity;*
- (c) *Congestion Zone;*
- (d) *Maximum value;*
- (e) *Units supplying energy; and*
- (f) *Other information required by ERCOT.*

**REFERENCE: PROTOCOL SECTION 4.9.4.2, PRINCIPLES FOR RESPONSIBILITY TRANSFERS**

- (1) *RspT may be used to shift responsibility for Supply of a defined maximum amount of MWs from one QSE to another QSE within the same Congestion Zone after the close of the Adjustment Period. As the RspT changes the responsibility for Supply of one QSE there must be an equal and opposite change in the responsibility for Supply of the other QSE.*
- (2) *One of the QSEs will act as the controller of the Real Time Dynamic signal. That Controlling Entity (CE) will send a Real Time power signal to ERCOT representing that QSE's power commitment to the other QSE, the Following Entity (FE).*
- (3) *ERCOT will use the dynamic power signal from the CE in its calculation of the CE's SCE. ERCOT will also use the dynamic power signal from the CE to calculate an equal and opposite value to use in calculation of the FE's SCE. The FE will use a signal from the CE to calculate its (the FE's) SCE.*
- (4) *ERCOT will integrate the dynamic power signal from the CE for each Settlement Interval and use this value as an offset in the CE's settlement for Resource imbalance. An equal but opposite offset will be used in the FE's settlement for Resource imbalance.*
- (5) *If the signal from the CE is lost, ERCOT will use the last good value received from the CE until the CE manually replaces the value, or the signal is restored.*

**[PRR428: Add Section 4.9.4.3 upon system implementation]**

**4.9.4.3 Principles for Responsibility Transfers For RMR Units**

- (1) *RspT may be used to schedule energy from an RMR Resource's QSE to ERCOT.*
- (2) *The RMR Resource's QSE will act as the controller of the Real Time Dynamic signal. The QSE will send a Real Time power signal to ERCOT representing the amount of RMR energy being delivered from RMR Resources to ERCOT by Congestion Zone. The dynamic signal will be consistent with and will not exceed the RMR deployment instructions from the final Delivery Plan and/or subsequent Adjustment Period changes, and the operation and availability of the RMR Resources.*



- (3) *ERCOT will use the dynamic power signal from the RMR QSE in its calculation of the RMR QSE's SCE.*
- (4) *ERCOT will integrate the dynamic power signal from the RMR QSE for each Settlement Interval and use this value as an offset in the RMR QSE's settlement for Resource imbalance.*
- (5) *If the signal from the Controlling Entity (CE) is lost, ERCOT will use the last good value received from the CE until the CE manually replaces the value, or the signal is restored.*

**REFERENCE: PROTOCOL SECTION 4.9.5, RESPONSIBILITY TRANSFER FOR BALANCING ENERGY BIDDING**

*Certain PUCT mandated Capacity Auction Products (as defined in PUCT S.R. §25.381) allow the entitlement holder (Buyer) to provide Balancing Energy Service to ERCOT whenever a Responsibility Transfer ("RspT") between Buyer and Seller's respective QSEs is established. The procedure for providing Balancing Energy from Capacity Auction Products is set forth in Protocols Section 6.5.2.1, Balancing Energy Service Bids from Bilateral Contracts.*

### 3.3 Document Control

#### *Authorities*

Prepared by	Date Completed	Reviewed by	Date Authorized
B. Garza	April 17, 2001	ROS	
I. Flores	April 15, 2002	OGRTF/ROS	
I. Flores	30 September 2002	OGRTF/ROS	
I. Flores	1 December 2002	OGRTF/ROS	
I. Flores	1 January 2003	OGRTF/ROS	
I. Flores	1 April 2003	OGRTF/ROS	
J. Gilbertson	29 August 2003		

#### *Distribution List*

Name	Organization
Reliability Operations Subcommittee	Technical Advisory Committee

#### *Change History*

Issue/Date	Reason for issue
Version 1.0 February 28, 2001	Updated from Working Group comments. Submitted to Technical Advisory Committee to approve handover to the Reliability Operating Subcommittee
Version 1.0a March 2, 2001	Inserted sections 3.2.4.2 – 3.2.4.4
Version 1.1 April 16, 2001	Clarified sections 3.2.4.2 – 3.2.4.4
May 1, 2002	OGRR101
October 1, 2002	OGRR113
December 1, 2002	OGRRs 114 & 116. Revised Sections 3.1.4.2, 3.1.4.3, 3.1.3.2 & 3.2.2.1 to match the Protocols references.
January 1, 2003	OGRR119, revised Section 3.1.3.1 to add a backup plan requirement for QSEs.
April 1, 2003	OGRR125 – updated Protocols referenced in Sections 3.1.3.2, 3.2.1.2, 3.2.2.1 & 3.2.6. OGRR126 – updated reference in Section 3.2.6 citing Protocols Sections 4.9.1, 4.9.2 & 4.9.3 and deleted redundant text after reference.
September 1, 2003	OGRR130 – revised Section 3.1.4.1 & 3.1.4.5.

Issue/Date	Reason for issue
	OGRR134 – revised Section 3.1.6.
April 1, 2004	OGRR142 – revised Section 3.1.3.4 & 3.1.5.1.
May 1, 2004	OGRR144 – revised Section 3.1.4.6 OGRR146 – revised Section 3.1.3.4 & 3.1.4.8.
June 1, 2004	OGRR145
November 1, 2004	OGRR152 and fixed typographical errors in Protocol references
December 1, 2004	OGRR153; Admin OGRR160
June 1, 2005	Admin OGRR168
November 1, 2005	OGRR154
February 1, 2006	Admin OGRR180
June 1, 2006	OGRR169, OGRR176, Admin OGRR185
February 1, 2007	Admin OGRR190
March 1, 2007	Admin OGRR191
July 1, 2007	Admin OGRR201
May 1, 2008	Admin OGRR207
June 1, 2008	Admin OGRR210
November 1, 2008	OGRR208
December 1, 2008	OGRR208 (Appeal); Admin OGRR215
March 1, 2009	OGRR213
April 1, 2009	OGRR221
May 1, 2009	OGRR213 (unboxed due to effective date)
June 1, 2009	Admin OGRR228
July 1, 2009	Admin OGRR230

---

---

# ***ERCOT OPERATING GUIDES***

---

---

## Section 4: Emergency Operation

---

---

### **Notifications, Transmission Security, EEA and Black Start**

June 1, 2009

**PUBLIC**

# Contents

<b>4.</b>	<b>EMERGENCY OPERATION .....</b>	<b>4-4</b>
4.1	INTRODUCTION .....	4-4
4.2	EMERGENCY NOTIFICATIONS .....	4-5
4.2.1	<i>Operating Condition Notice</i> .....	4-5
4.2.2	<i>Advisory</i> .....	4-6
4.2.3	<i>Watch</i> .....	4-7
4.2.4	<i>Emergency Notice</i> .....	4-9
4.3	OPERATION TO MAINTAIN TRANSMISSION SYSTEM SECURITY .....	4-11
4.3.1	<i>Remedial Action Plans</i> .....	4-13
4.4	BLOCK LOAD TRANSFERS BETWEEN ERCOT AND NON-ERCOT CONTROL AREAS .....	4-14
4.4.1	<i>Introduction and General Information</i> .....	4-15
4.4.2	<i>BLTs to ERCOT</i> .....	4-15
4.4.3	<i>BLTs from ERCOT</i> .....	4-16
4.5	ENERGY EMERGENCY ALERT (EEA).....	4-17
4.5.1	<i>General</i> .....	4-20
4.5.2	<i>Operating Procedures</i> .....	4-20
4.5.3	<i>Implementation</i> .....	4-21
4.6	BLACK START .....	4-26
4.6.1	<i>Principles</i> .....	4-27
4.6.2	<i>Strategies</i> .....	4-27
4.6.3	<i>Priorities</i> .....	4-28
4.6.4	<i>Responsibilities</i> .....	4-28
4.6.5	<i>Emergency Back Up Communication Facilities Criteria</i> .....	4-30
4.7	DOCUMENT CONTROL .....	4-31
Attachment 4A:	Detailed Black Start Information.....	4-33
4A.1	<i>CONSIDERATIONS FOR SYSTEM RESTORATION</i> .....	4-33
4A.2	<i>ERCOT COORDINATION</i> .....	4-37
4A.3	<i>Considerations For Black Start Testing</i> .....	4-38
4A.4	<i>Criteria for ERCOT and Transmission Operator Black Start Plans</i> .....	4-38

# Protocol References

<b>REFERENCE: PROTOCOL SECTION 5.6.3, OPERATING CONDITION NOTICE</b> .....	4-5
<b>REFERENCE: PROTOCOL SECTION 5.6.4, ADVISORY</b> .....	4-6
<b>REFERENCE: PROTOCOL SECTION 5.6.5, WATCH</b> .....	4-7
<b>REFERENCE: PROTOCOL SECTION 5.6.6, EMERGENCY NOTICE</b> .....	4-9
<b>REFERENCE: PROTOCOL SECTION 5.7, BLOCK LOAD TRANSFERS BETWEEN ERCOT AND NON-ERCOT CONTROL AREAS</b> .....	4-14
<b>REFERENCE: PROTOCOL SECTION 5.6.6.1, ENERGY EMERGENCY ALERT (EEA)</b> .....	4-17
<b>REFERENCE: PROTOCOL SECTION 5.6.7, EEA LEVELS</b> .....	4-18
<b>REFERENCE: PROTOCOL SECTION 5.6.7.1, RESTORATION OF MARKET OPERATIONS</b> .....	4-19
<b>REFERENCE: PROTOCOL SECTION 6.1.13, EMERGENCY INTERRUPTIBLE LOAD SERVICE (EILS)</b> 4-19	
<b>REFERENCE: PROTOCOL SECTION 22A, STANDARD FORM BLACK START AGREEMENT (IN PART)</b> 4-26	
<b>REFERENCE: PROTOCOL SECTION 6.4.2, DETERMINATION OF ERCOT CONTROL AREA REQUIREMENTS (IN PART)</b> .....	4-30

## 4. Emergency Operation

### 4.1 Introduction

Emergency operation is intended to address operating conditions under which the reliability of the ERCOT System is inadequate and there is no market solution readily apparent. During a declared system emergency, ERCOT can instruct Transmission and/or Distribution Service Providers (TDSPs) and Qualified Scheduling Entities (QSEs) to take specific operating actions that would otherwise be discretionary. Upon receiving a valid Dispatch Instruction from ERCOT, and in compliance with the Operating Guides, the QSEs shall direct relevant Resources or groups of Resources to respond to the instruction ERCOT shall coordinate with QSEs and TDSPs to assure that necessary actions are taken to maintain service reliability under any circumstances.

It is essential that good, timely, and accurate communication routinely occur between ERCOT, TDSPs, and QSEs. QSE and TDSP personnel will report unplanned equipment status changes as outlined in Section 4, Emergency Operation. ERCOT System Operators may ask for status updates as required in order to gather information to make decisions on system conditions to determine what type of emergency communication may be appropriate.

ERCOT may issue communications in the form of Notices, Advisories, Watches, and Emergency Notices. These communications may relate to weather, transmission, distribution, and/or generation information and shall specify the severity of the situation, the area affected, the areas potentially affected, and the anticipated duration of the Emergency Condition. These communications will be issued by ERCOT to inform all Transmission Operators (TOs) and QSEs of the current operating situation. TOs will notify their represented TDSPs, and QSEs will in turn notify the appropriate Resources and Retail Electric Providers (REPs). QSEs and TDSPs should establish and maintain internal procedures for contingency preparedness or to expedite the resolution of the conditions communicated by ERCOT that threatens system reliability.

Before deciding which emergency communication to issue, ERCOT must consider the possible severity of the operating situation and the time and resources available for the market to respond before an Emergency Condition occurs. If practicable, the market must be allowed to work to mitigate or eliminate any possible Emergency Condition. ERCOT has the responsibility to issue the appropriate communications to facilitate a market solution to the problem.

Section 4.2, Emergency Notifications, describes various types of emergency operation and the associated permissible actions that can be ordered by ERCOT.

## 4.2 Emergency Notifications

### 4.2.1 Operating Condition Notice

**REFERENCE: PROTOCOL SECTION 5.6.3, OPERATING CONDITION NOTICE**

*ERCOT will issue an Operating Condition Notice (OCN) to inform all QSEs of a possible future need for more Resources due to conditions that could affect ERCOT System reliability. OCNs are for informational purposes only, and ERCOT exercises no extra operational authority with the issuance of this type of notice, but may solicit additional information from QSEs in order to determine whether the issuance of an Advisory, Watch, or Emergency Notice is warranted.*

*When time permits, ERCOT will issue an OCN before issuing an Advisory, Watch, or Emergency Notice. However, issuance of an OCN may not require action on the part of any Market Participant, but rather simply serves as a reminder to QSEs and TDSPs that some attention to the changing condition may be warranted. OCNs serve to communicate to QSEs the need to take extra precautions to be prepared to serve the Load during times when contingencies are most likely to arise.*

*Reasons for OCNs include unplanned transmission outages, and weather related concerns such as anticipated freezing temperatures, hurricanes, wet weather, and ice storms.*

*ERCOT will monitor actual and forecasted weather for ERCOT and adjacent NERC regions. When adverse weather conditions are expected, ERCOT may confer with TDSPs and QSEs regarding the potential for adverse reliability impacts and contingency preparedness. Based on its assessment of the potential for adverse conditions, ERCOT may require information from QSEs representing Resources regarding their fuel capabilities. Requests for this type of information shall be for a time period of no more than seven (7) days from the date of the request. The specific information which may be requested shall be defined in the Operating Guides. QSEs representing Resources shall provide the requested information in a timely manner, as defined by ERCOT at the time of the request.*

*QSEs and TDSPs are expected to establish and maintain internal procedures for monitoring actual and forecasted weather and for implementing appropriate measures when the potential for adverse weather or other conditions (which could threaten ERCOT System reliability) arise.*

An Operating Condition Notice (OCN) will be issued by ERCOT to inform all Qualified Scheduling Entities (QSEs) of a possible future need for more Resources because of conditions that could affect reliability. OCNs are for communication only, and ERCOT exercises no extra authority with the issuance of this type of notice.

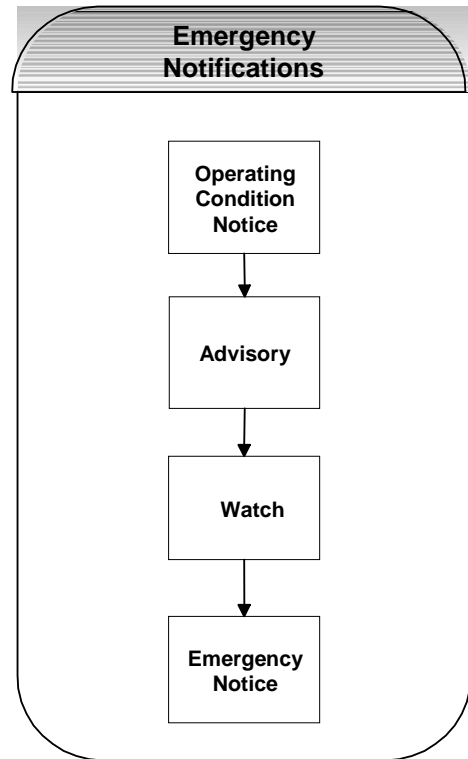



When time permits, ERCOT will issue an OCN prior to issuance of an Advisory, Watch, or Emergency Notice. However, issuance of an OCN does not require action on the part of any Market Participant, but rather simply serves as a reminder for QSEs and Transmission and/or Distribution Service Providers (TDSPs) that some attention to the changing condition may be warranted. OCNs serve to communicate to QSEs the need to take extra precautions to be prepared to serve the Load during times when contingencies are most likely to arise.

Weather-related OCNs include notices of anticipated freezing temperatures, hurricanes, wet weather, and ice storms as provided to ERCOT by TDSPs. An example of another type of OCN is notice of unplanned transmission outages. ERCOT will monitor actual and forecasted weather for ERCOT and adjacent North American Electric Reliability Corporation (NERC) regions. When adverse weather conditions are expected, ERCOT may confer with TDSPs and QSEs regarding the potential for adverse reliability impacts and contingency preparedness. QSEs and TDSPs are expected to establish and maintain internal procedures for monitoring actual and forecasted weather and for implementing appropriate measures when the potential for adverse weather or other conditions arise which could threaten ERCOT System reliability.

#### 4.2.2 Advisory

##### **REFERENCE: PROTOCOL SECTION 5.6.4, ADVISORY**

*ERCOT will issue an Advisory for informational purposes for the following reasons:*

- (1) *When it recognizes that conditions are developing or have changed and more Ancillary Services will be needed to maintain current or near-term operating reliability;*
- (2) *When weather or ERCOT System conditions require more lead-time than the normal Day Ahead market allows;*
- (3) *When communications or other controls are significantly limited, or*
- (4) *When ERCOT Transmission Grid conditions are such that operations within first contingency criteria as defined in the Operating Guides are not likely or possible because of Forced Outages or other conditions.*

*The Advisory communicates existing constraints. ERCOT will notify TDSPs and QSEs. QSEs will notify appropriate Resources and LSEs. ERCOT will communicate with TDSPs as needed to confirm their understanding of the condition and to determine the availability of Transmission Facilities. For the purposes of verifying submitted information, ERCOT may communicate with QSEs.*

*Although an Advisory is for information purposes, ERCOT may exercise its authority, in such circumstances, to increase Ancillary Service requirements above the quantities specified in the normal Day Ahead plan in accordance with scheduling procedures. ERCOT may also increase the Day Ahead market to Two Days Ahead. ERCOT may require information from QSEs representing Resources regarding their fuel capabilities. Requests for this type of information shall be for a time period of no more than seven (7) days from the date of the request. The specific information which may be requested shall be defined in the Operating Guides. QSEs representing Resources shall provide the requested information in a timely manner, as defined by ERCOT at the time of the request.*

An Advisory will be issued by ERCOT when it recognizes that conditions are developing or have changed such QSE or TDSP action is prudent in response to impending severe conditions.

An Advisory may be issued in response to:

- Concern at ERCOT about the availability of Resources to serve anticipated demand
- Projected insecure conditions due to unacceptable loading conditions
- Communication or control limitations

The Advisory communicates what constraints or insecure states are expected.

In the event of an Advisory, ERCOT will notify TOs and QSEs and post the information on the MIS.

QSEs will notify appropriate Resources and REPs.

TOs will notify their represented TDSPs as appropriate.

An Advisory is for communication, but with the issuance of an Advisory ERCOT may exercise its authority to increase Ancillary Service requirements above the quantities specified in the normal Day-Ahead plan in accordance with scheduling procedures. ERCOT may also increase the Day-Ahead market to Two-Days-Ahead.

ERCOT will communicate with TDSPs as needed to confirm their understanding of the condition and to determine availability of equipment and Resources. For the purpose of verifying submitted information, ERCOT may also communicate with QSEs.

### 4.2.3 Watch

#### **REFERENCE: PROTOCOL SECTION 5.6.5, WATCH**

*ERCOT will issue a Watch when ERCOT determines:*

- (1) *That conditions have developed such that additional Ancillary Services are needed in the Operating Period;*
- (2) *That market Congestion Management techniques specified in these Protocols will not be adequate to resolve transmission problems; or*
- (3) *Forced Outages or other abnormal operating conditions occur which require operations outside first contingency security limits as defined in the ERCOT Operating Guides;*
- (4) *That there are insufficient Ancillary Service bids.*

*ERCOT will post the Watch electronically and will notify all TDSPs and QSEs via the Messaging System of the posted Watch(es).*

*ERCOT must issue a Watch before acquiring Emergency Short Supply Regulation Services (RGS), Emergency Short Supply Responsive Reserve Services (RRS) or Emergency Short Supply Non-Spinning Reserve Services (NSRS). With the issuance of a Watch pursuant to item (1) or (4) above, ERCOT may exercise its authority to immediately procure the following services from existing bids:*

- (1) RGS;*
- (2) RRS; and*
- (3) NSRS.*

*Emergency Short Supply RGS, Emergency Short Supply RRS or Emergency Short Supply NSRS will be procured if there is insufficient availability of bids for any of the listed Ancillary Services.*

*ERCOT will post the Watch electronically on the Market Information System (MIS) and will notify all TDSPs and QSEs via the Messaging System of the posted Watch(es).*

*Corrective actions identified by ERCOT shall be communicated through Dispatch Instructions to TDSPs and/or QSEs required to implement the corrective action. Each QSE shall immediately notify the Market Participants that it represents of such Watch. To minimize the effects on the ERCOT System, all TDSPs will identify and prepare to implement actions, including restoring outaged lines as appropriate and preparing for Load shedding. ERCOT may instruct TDSPs to reconfigure ERCOT System elements as necessary to improve the reliability of the ERCOT System. On notification of a Watch, each QSE and TDSP will prepare for an emergency in case conditions worsen. ERCOT may require information from QSEs representing Resources regarding their fuel capabilities. Requests for this type of information shall be for a time period of no more than seven (7) days from the date of the request. The specific information which may be requested shall be defined in the Operating Guides. QSEs representing Resources shall provide the requested information in a timely manner, as defined by ERCOT at the time of the request.*

A Watch may be issued by ERCOT when it recognizes that conditions have developed such that an insecure operating state exists or is imminent.

With the issuance of a Watch, ERCOT may exercise its authority to ask for a quick bid response that precludes the QSEs having sufficient time to Self-Arrange additional Ancillary Services (Regulation Services (RGS), Responsive Reserve Services (RRS), and Non-Spinning Reserve Services (NSRS)). These additional Ancillary Services bids must be submitted by the market promptly in compliance with the scheduling protocol (within fifteen (15) minutes).

A Watch may also be issued by ERCOT when it recognizes that market Congestion management techniques specified in these protocols will not be adequate to resolve transmission problems.

A Watch will be issued by ERCOT when Forced Outages or other abnormal operating conditions occur which require operations outside first contingency security limits. ERCOT will notify all TOs and QSEs and will post the Watch. TOs should notify their represented TDSPs. QSEs should notify appropriate resources and REPs. Identified corrective actions shall be implemented. To minimize the effects on the ERCOT System, all TDSPs will identify and prepare to implement actions, including restoring outaged lines as appropriate

and preparation for Load shedding. ERCOT may instruct reconfiguration of ERCOT System elements by TDSPs necessary to improve the reliability of ERCOT as a whole. On notification of a Watch, each QSE and TDSP will prepare for an emergency in case conditions worsen.

#### 4.2.4 Emergency Notice

**REFERENCE: *PROTOCOL SECTION 5.6.6, EMERGENCY NOTICE***

*ERCOT will issue an Emergency Notice only for the following reasons:*

- (1) ERCOT cannot maintain minimum reliability standards (for reasons including fuel shortages) during the Operating Period using every Resource practicably obtainable from the market;*
- (2) ERCOT is in an unreliable condition, as defined below;*
- (3) Immediate action must be taken to avoid or relieve an overloaded transmission element; or*
- (4) ERCOT varies from timing requirements or omits one or more scheduling procedures, as described in Section 4.8, Temporary Deviations from Scheduling Procedures.*

*The actions ERCOT takes during an Emergency Condition will depend on the nature and severity of the situation.*

*ERCOT is considered to be in an unreliable condition whenever ERCOT Transmission Grid status is such that the most severe single-contingency event presents the threat of uncontrolled separation or cascading outages and/or large-scale service disruption to Load (other than Load being served from radial transmission service) and/or overload of a critical transmission element, and no timely solution is obtainable from the market.*

*If the Emergency Condition is the result of a transmission problem that puts ERCOT in an unreliable condition, then ERCOT will act immediately to return ERCOT to a reliable condition, including instructing Resources to change output and instructing TDSPs to drop Load.*

*If the Emergency Condition is the result of a short supply situation, each QSE having bid extra capacity during the Advisory period that is normally not readily available due to ramp rate limitations, will immediately update their HSL of any online Resource that is capable of providing extra capacity within thirty (30) minutes. The HSL shall be set to equal the HOL rating of the online Resource minus the Ancillary Services Obligation. The extra capacity must already be part of the QSE's Up Balancing bid curve in order for Scheduling, Pricing and Dispatch (SPD) to utilize the updated HSL.*

*If the short supply Emergency Condition continues, then the Energy Emergency Alert (EEA) procedures will be followed.*

ERCOT is considered to be in an insecure state whenever ERCOT Transmission Grid status is such that the most severe single-contingency even presents the threat of uncontrolled separation of cascading outages and/or large-scale service disruption to Load (other than Load being served from a single-feed transmission service) and/or overload of a critical transmission element, and no timely solution is obtainable from the market.

ERCOT will only issue an Emergency Notice when it recognizes that immediate action is required because:

- ERCOT cannot maintain minimum reliability standards (for reasons including fuel shortages) during the Operating Period using every Resource practicably obtainable from the market
- ERCOT must avoid or relieve an overloaded transmission element
- ERCOT is in an insecure state
- ERCOT varies from Timing Requirements or omits one or more Scheduling Procedures

The actions ERCOT takes during a declared emergency will depend on the nature and severity of the situation. If the emergency is the result of a transmission problem that puts ERCOT in an insecure state, then ERCOT will act immediately to return ERCOT to a reliable condition, including instructing Resources to change output and instructing TDSPs to drop Load. TDSPs and Resources are required to implement the instructions and notify ERCOT when actions are complete.

If the emergency is the result of a short supply situation, then the Energy Emergency Alert procedures will be followed.

### 4.3 Operation To Maintain Transmission System Security

ERCOT Operators are responsible for operating the ERCOT Transmission systems within first contingency transfer limits so that there is no overload of any significant transmission element whose loss could jeopardize the reliability of the ERCOT System. Whenever the ERCOT System is not engaged in emergency operation, it will be operated in such a manner that the occurrence of a single contingency will not cause any of the following:

- a. Uncontrolled breakup of the transmission system,
- b. Loading of Transmission Facilities above defined emergency ratings which can not be eliminated in time to prevent damage or failure following the loss through execution of specific, predefined operating procedures,
- c. Transmission voltage levels outside system design limits which can not be corrected through execution of specific, predefined operating procedures before voltage instability or collapse occurs, or
- d. Customer outages, except for high set interruptible and radially served Loads.

“Single contingency” criteria are specified as follows:

A credible single contingency is defined as the Forced Outage of two generating units as defined in Section 5.1.4, Transmission Reliability Testing, item (2), in the ERCOT System within a short period of time, or the Forced Outage of any single transmission element (such as a circuit or transformer).

The Forced Outage of a double-circuit transmission line (DCKT) in excess of 0.5 miles in length will always be considered a credible single contingency for all security constrained unit commitment decisions such as OOMC and Replacement Reserve Service.

The Forced Outage of a double-circuit transmission line (DCKT) will only be considered a credible single contingency for energy deployment decisions such as OOME and Zonal Balancing Energy for any of the following operating conditions characterized by high DCKT Outage probability or consequence:

#### **High Outage Probability**

- Severe weather conditions are forecasted by ERCOT in the vicinity of the DCKT.
- Weather conditions indicate a high risk of insulator flashover on the DCKT.
- Individual circuits that are part of the DCKT have experienced repeated Forced Outages within the preceding 48 hours possibly indicating unresolved problems.
- A high risk of DCKT Outage exists due to fire in progress near the DCKT right-of-way.

### High Outage Consequence

- Another transmission Facility, which significantly increases the impact of an Outage to the DCKT, is out of service.
- Studies affirmatively indicate Outage of the DCKT would result in cascading outages or voltage collapse.
- Studies affirmatively indicate Outage of the DCKT poses a significant risk of uncontrolled outages because it would result in equipment overloads, which cannot be eliminated through execution of specific, predefined operating procedures (i.e. RAPs which may include the use of energy Dispatch Instructions such as OOME or BES, with consideration for the ability of Generation Resources to perform such Dispatch Instructions) in time to prevent equipment damage or failure.

The Control Area Authority can order the following actions when the above criteria is not met if such actions assist the TDSP in meeting their responsibilities:

<b>EMERGENCY CONDITION</b>	<b>CONTROL AREA AUTHORITY ACTION</b>
Significant Transmission Overload	<ol style="list-style-type: none"> <li>1. The Control Area Authority can order adjustment to unit generation schedules (unit specific balancing instructions), switching of transmission elements or Load interruption to relieve a severely overloaded transmission element.</li> <li>2. The Control Area Authority can order a transmission element whose loss would not have a significant impact on the reliability of ERCOT transmission system switched out to increase interconnected system transfers.</li> </ol>
Violation of “First Contingency” Criteria	The Control Area Authority can order changes to unit dispatch or commitment to eliminate a “first contingency” criteria violation. Normally these changes should be performed via the market control mechanisms of constraint management as described in the ERCOT protocols, but ERCOT operators have the authority to issue valid Dispatch Instructions independent of these systems.
Violation of Voltage/Reactive Criteria	The Control Area Authority can order changes in unit dispatch if coordinated voltage and Reactive Power criteria that are considered critical to interconnection reliability are violated for the existing or first contingency conditions.
Total or Partial System Blackout	Implement Black Start Procedure

TDSP operators are responsible for operating the sub-transmission system within safe operating limits, for maintaining the transmission system, for performing all switching operations after coordinating with ERCOT, and for notifying ERCOT operators of threats to, or overloads of the transmission system under their supervision.

#### 4.3.1 Remedial Action Plans

Generating plants or constrained transmission elements that would otherwise be subject to restrictions can operate to full rating if appropriate Special Protection Systems (SPS) or Remedial Action Plans (RAP) are in place. See Section 7.2.2, Design and Operating Requirements for ERCOT System Facilities, for SPS requirements. A RAP refers to predetermined operator actions to maintain reliability in a defined adverse operating condition. Normally, it is desirable that TDSP constructs Transmission Facilities adequate to eliminate the need for any RAP; however, in some circumstances, such construction may be unachievable in the available time frame. A RAP may be proposed by any ERCOT Market Participant, but must be approved by ERCOT prior to implementation. Any ERCOT RAP must meet the following requirements:

- a. Coordinated and approved with the owners and operators of facilities included in the RAP.
- b. Use is limited to the time required to construct replacement Transmission Facilities. However, the RAP will remain in effect, if replacement Transmission Facilities have been determined by the Control Area Authority to be impractical.
- c. Complies with all applicable ERCOT and NERC requirements.
- d. ERCOT develops and posts a methodology to include the RAP in the Total Transfer Capability (TTC) calculations, if appropriate.
- e. Clearly defines and documents operator actions.
- f. Includes the option for the transmission operator to override the procedures if the RAP will not improve system reliability.
- g. Operators must be trained in RAP implementation.



#### 4.4 Block Load Transfers between ERCOT and Non-ERCOT Control Areas

**REFERENCE: PROTOCOL SECTION 5.7, BLOCK LOAD TRANSFERS BETWEEN ERCOT AND NON-ERCOT CONTROL AREAS**

*Under Watch, EEA, or other Emergency Conditions, it may be necessary for ERCOT to request the implementation of Block Load Transfer (BLT) schemes which will transfer Loads normally located in the ERCOT Control Area to a non-ERCOT Control Area. Similarly, when non-ERCOT Control Areas experience certain transmission contingency or short supply conditions, it may be necessary for ERCOT to agree to the implementation of BLT schemes which will transfer Loads normally located in a non-ERCOT Control Area to the ERCOT Control Area. BLTs will be restricted to the following conditions:*

- (1) *BLTs shall occur only under a specific Dispatch Instruction from ERCOT.*
- (2) *BLTs that are looped systems may be tied to the other Control Area's electrical system through multiple interconnection points at the same time. Transfers of looped configurations will be permitted only if all interconnection points are netted under a single Electric Service Identifier (ESI ID). Individual meter points for looped system BLTs must be within the same Congestion Zone.*
- (3) *BLTs of Load to the ERCOT Control Area will be:*
  - (i) *Treated as non-competitive wholesale Load in the ERCOT settlement system,*
  - (ii) *Registered in a manner similar to that of Non-Opt In Entities (NOIEs), and*
  - (iii) *Responsible for Unaccounted For Energy (UFE) allocations and Transmission Losses consistent with similarly situated NOIE metering points.*
- (4) *BLTs of Load to the ERCOT Control Area will be permitted only if such transfers will not jeopardize the reliability of the ERCOT System. Under an ERCOT Emergency Notice, BLTs that have been implemented may be curtailed or terminated by ERCOT in order to maintain the reliability of the ERCOT System.*
- (5) *BLTs of Load from the ERCOT Control Area will be treated as a Resource in the ERCOT settlement system.*
- (6) *BLTs of Load from the ERCOT Control Area will be sent Dispatch Instructions only with the permission of the affected non-ERCOT Control Area. Under emergency conditions, BLTs that have been implemented may be curtailed or terminated by the non-ERCOT Control Area in order to maintain the reliability of the non-ERCOT system.*
- (7) *Restoration of service to outage Customers using BLTs will be accomplished, as quickly as possible, if the transfers will not jeopardize the reliability of the ERCOT System and only under specific Dispatch Instruction from ERCOT.*
- (8) *The necessary Market Participant agreements, metering, and ERCOT settlement systems are in place prior to the implementation of any BLT.*

- (9) *Transmission BLT metering points utilized five (5) or more time per year, as monitored by the Transmission and/or Distribution Service Provider (TDSP), will conform to ERCOT Polled Settlement (EPS) metering requirements as defined in Section 10, Metering, and the Settlement Metering Operating Guide. BLT metering points that are Distribution Systems or are transmission BLT metering points used less than five (5) times per year will be Revenue Quality Meters, four (4) channel bi-directional kWh/kVARh, fifteen (15) minute Interval Data Recorder (IDR) metering with remote interrogation. ERCOT may impose additional metering requirements as deemed necessary to ensure ERCOT System reliability and integrity.*

#### **4.4.1 Introduction and General Information**

Under a Watch, Energy Emergency Alert (EEA) conditions, or for local transmission constraints it may be necessary for ERCOT to request the implementation of Block Load Transfer (BLT) schemes which will transfer Loads normally located in the ERCOT Control Area to a non-ERCOT Control Area. Similarly, when non-ERCOT Control Areas experience certain transmission contingency or short supply conditions or for economic reasons, ERCOT may be requested to transfer Loads normally located in a non-ERCOT Control Area to the ERCOT Control Area.

BLTs shall only occur under a specific Dispatch Instruction from ERCOT to the appropriate Transmission Operators (TOs). BLTs to or from ERCOT may be curtailed or terminated in order to maintain the reliability of the supporting system. BLTs that are looped systems may be tied to the other power pool's electrical system through multiple interconnection points at the same time provided there are no reliability concerns and the interconnection points are netted under a single Electric Service Identifier (ESI ID). Also, restoration of service to outage Customers using BLTs will be accomplished, as quickly as possible if the transfers will not jeopardize reliability.

To enhance the communications ERCOT may request that a conference call be implemented at the appropriate time between ERCOT, the TO and the non-ERCOT Control Area.

Loads transferred to or from ERCOT shall meet the reactive and capacitive support requirements of the supporting system.

#### **4.4.2 BLTs to ERCOT**

BLTs of Load to the ERCOT Control Area will be treated as Load in the ERCOT settlement system and will have an ESI ID associated with it. The QSE of the LSE assigned to the ESI ID associated with a BLT Point will include that Load in its Balanced Schedules.

The party requiring assistance shall make arrangements with the appropriate QSE for the generation supply and then shall request a time and amount with the TO for the Load transfer. The TO and ERCOT shall determine the maximum amount of Load that the ERCOT transmission grid can support and/or approve the requested amount and the TO will communicate this to the requesting party and ERCOT will coordinate with the QSE. The actual switching to and from ERCOT shall take place at an agreed upon time by ERCOT, the TO and the requesting party.

#### **4.4.3 BLTs from ERCOT**

BLTs of Load from the ERCOT Control Area will be treated as a Resource in the ERCOT settlement system and will be established as a pseudo generation facility. The QSE of the Resource associated with a BLT Point will include that Resource in its Resource Plan. The QSE will not be required to provide the real time data to ERCOT normally provided for Resources. The Resource Plan shall reflect the availability of the resource, but ERCOT shall confirm its availability with the Non-ERCOT control area prior to issuing any dispatch instructions to the QSE and the TO. Any energy delivered under such a dispatch instruction shall be treated as an OOME instruction to the QSE.

ERCOT will notify the TO to make preparations for switching Load from ERCOT with a requested amount to transfer. The supporting entity shall determine the maximum amount of Load that their transmission grid can support and/or approve the requested amount and communicate this to the TO who will forward amount and time to ERCOT. ERCOT will coordinate with the appropriate QSE. The actual switching from and back to ERCOT shall take place at an agreed upon time by ERCOT, the TO and the supplying power grid.

## 4.5 Energy Emergency Alert (EEA)

### **REFERENCE: PROTOCOL SECTION 5.6.6.1, ENERGY EMERGENCY ALERT (EEA)**

*At times it may be necessary to reduce electrical Demand because of a temporary decrease in available electricity supply. To provide orderly, predetermined procedures for curtailing Demand during such emergencies, ERCOT will initiate and coordinate the implementation of the Energy Emergency Alert following the EEA levels set forth below in Section 5.6.7, EEA Levels.*

*The objective of the EEA is to provide for maximum possible continuity of service while maintaining the integrity of the ERCOT Transmission Grid in order to reduce the chance of cascading outages.*

*ERCOT's operating procedures shall meet the following goals while continuing to respect the confidentiality of market sensitive data:*

- (1) Use of the market to the fullest extent practicable without jeopardizing the reliability of the ERCOT System;*
- (2) Use of Responsive Reserve Services and other Ancillary Services to the extent permitted by ERCOT System conditions;*
- (3) Maximum use of ERCOT System capability;*
- (4) Maintenance of station service for nuclear Generation Resource Facilities;*
- (5) Securing of startup power for Generation Resources;*
- (6) Operation of power Generation Resources during loss of communication with ERCOT;*
- (7) Restoration of service to critical Loads in the manner defined in the Operating Guides; and*
- (8) Restoration of service to all customers following major system disturbances, giving priority to the larger groups of Customers.*

*ERCOT shall be responsible for coordinating with QSEs and TDSPs to monitor system conditions, initiating the EEA levels, notifying all QSEs, and coordinating the implementation of the EEA levels while maintaining transmission security limits.*

*ERCOT, at management's discretion, may at any time issue an ERCOT-wide appeal through the public news media for voluntary energy conservation.*

*During the EEA, ERCOT has the authority to obtain energy from Direct Current (DC) Ties or Block Load Transfers (BLTs) from non-ERCOT Control Areas when capacity is available.*

*Some of the EEA levels will not be applicable if transmission security violations exist. There may be insufficient time to implement all levels in sequence, but to the extent practicable, ERCOT will use Ancillary Services which bidders have made available in the market to maintain or restore reliability.*

*ERCOT may immediately implement EEA Level 3 any time the steady-state system frequency is below 59.8 Hz and will immediately implement EEA Level 3 any time the steady-state frequency is below 59.5 Hz.*

*Percentages for EEA Level 3 Load shedding will be based on previous year's TDSP peak Loads, as reported to ERCOT, and will be reviewed by ERCOT and modified annually.*

**REFERENCE: PROTOCOL SECTION 5.6.7, EEA LEVELS**

***EEA Level 1 — Maintain ERCOT Physical Responsive Capability (PRC) on Resources plus RRS MW provided from LaaR Equal to 2300 MW.***

*ERCOT will:*

- (1) Utilize available DC Tie capability that is not already being used by the market;*
- (2) Notify the Southwest Power Pool (SPP) Security Coordinator; and*
- (3) Issue Out of Merit Order (OOM) Dispatch Instructions to uncommitted units available within the expected timeframe of the emergency.*
- (4) Inquire about availability of BLTs.*

*QSEs will:*

- (1) Notify ERCOT of any Resources uncommitted but available in the timeframe of the emergency.*
- (2) Immediately update the HSL of any On-line Resource that is capable of providing extra capacity within thirty (30) minutes. The extra capacity must already be part of the QSE's Up Balancing bid curve in order for SPD to utilize the updated Resource Plan.*

***EEA Level 2A — Maintain ERCOT Physical Responsive Capability (PRC) on Resources plus RRS MW Provided from LaaR Equal to 1750 MW.***

*In addition to measures associated with EEA Level 1, ERCOT will:*

- (1) Instruct TDSPs to reduce Customers' Load by using distribution voltage reduction measures, if deemed beneficial by the TDSP;*
- (2) Instruct QSEs to deploy all Responsive Reserve, which is supplied from Load acting as a Resource (LaaR) (controlled by high-set under-frequency relays); and*
- (3) With the approval of the affected non-ERCOT Control Area, may instruct TDSPs to implement BLTs, which transfer load from the ERCOT Control Area to non-ERCOT Control Areas. Use of a BLT will be defined in the ERCOT Operating Guides.*

***EEA Level 2B – Maintain system frequency at 60 Hz:***

*Following deployment of the measures associated with EEA Level 1 and Level 2A, ERCOT will deploy all available Emergency Interruptible Load Service (EILS) Resources as a single block via a single Verbal Dispatch Instruction to all QSEs providing EILS.*

*Unless a media appeal is already in effect, ERCOT shall issue an appeal through the public news media for voluntary energy conservation.*

***EEA Level 3 — Maintain system frequency at 59.8 Hz or greater***

*In addition to measures associated with EEA Levels 1, 2A and 2B, ERCOT will direct all TDSPs and their agents to shed firm Load, in one hundred (100) megawatt (MW) blocks, distributed as agreed and documented in the ERCOT Operation procedures in order to maintain a steady state system frequency of 59.8 Hertz (Hz). ERCOT may take this action prior to the expiration of the ten (10) minute EILS Resource deployment period if ERCOT, in its sole discretion, believes that shedding firm Load is necessary to maintain the stability of the ERCOT System. If, due to ERCOT System conditions, EILS Resources are not deployed prior to this action, ERCOT shall deploy EILS Resources as soon as possible following this action.*

*In addition to measures associated with EEA Levels 1, 2A and 2B, TDSPs will keep in mind the need to protect the safety and health of the community and the essential human needs of the citizens. Whenever possible, TDSPs shall not manually drop Load connected to under-frequency relays during the implementation of the EEA.*

***REFERENCE: PROTOCOL SECTION 5.6.7.1, RESTORATION OF MARKET OPERATIONS***

*ERCOT shall continue the EEA until sufficient bids are received and deployed by ERCOT to eliminate the conditions requiring the EEA. ERCOT shall release EILS Resources after both the restoration of RRS capacity and initiation of the restoration of Loads acting as Resources.*

*Upon ERCOT notifying the market that the EEA is cancelled, each QSE that enabled extra capacity during Emergency Condition or EEA will remove the extra capacity from the Up Balancing bid stack and adjust the HSL of any online Resource within fifteen (15) minutes to a level that ensures compliance with all applicable standards.*

***REFERENCE: PROTOCOL SECTION 6.1.13, EMERGENCY INTERRUPTIBLE LOAD SERVICE (EILS)***

*Consistent with subsection (a) of P.U.C. SUBST. R. 25.507, Electric Reliability Council of Texas (ERCOT) Emergency Interruptible Load Service (EILS), EILS is defined as a special emergency service used during an Energy Emergency Alert (EEA) Level 2B or Level 3 to reduce Load and assist in maintaining or restoring ERCOT System frequency.*

***As provided by ERCOT to QSEs:*** *A special emergency service used by ERCOT in EEA Level 2B prior to ERCOT instructing Transmission and/or Distribution Service Providers (TDSPs) to shed firm Load, or in EEA Level 3 if deployment in EEA Level 2B was not possible.*

*As provided by a QSE to ERCOT: The provision of capacity by Load Resources capable of reducing their electricity consumption during EEA Level 2B or EEA Level 3.*

#### 4.5.1 General

At times it may be necessary to reduce electrical Demand because of a temporary shortfall in available electricity supply. The reduction in supply could be caused by emergency outages of generators, transmission equipment, or other critical facilities; by short-term unavailability of fuel or generation; or by requirements or orders of government agencies. To provide an orderly, predetermined procedure for curtailing demand during such emergencies, ERCOT has established this Energy Emergency Alert (EEA).

The objective of the EEA is to provide for maximum possible continuity of service while maintaining the integrity of the ERCOT Transmission Grid in order to reduce the chance of cascading outages.

#### 4.5.2 Operating Procedures

The ERCOT System Operators have the authority to make and carry through decisions that are required to operate the ERCOT System during emergency or adverse conditions. ERCOT will have sufficiently detailed operating procedures for emergency or short supply situations and for restoration of service in the event of a partial or complete system shutdown. These procedures will be distributed to the personnel responsible for performing specified tasks to handle emergencies, remedy short supply situations, or restore service. TDSPs will develop procedures to be filed with ERCOT describing implementation of ERCOT requests in emergency and short supply situations, including interrupting Load, notifying others and restoration of service.

ERCOT and each TDSP will endeavor to maintain transmission ties intact if at all possible. This will: (1) permit rendering the maximum assistance to an area experiencing a deficiency in generation, (2) minimize the possibility of cascading loss to other parts of the system, and (3) assist in restoring operation to normal.

ERCOT's operating procedures will meet the following goals while continuing to respect the confidentiality of market sensitive data. If all goals cannot be respected simultaneously then the priority order listed below shall be respected:

1. Maintain station service for nuclear generating facilities.
2. Securing startup power for power generating plants.
3. Operating generating plants isolated from ERCOT without communication.
4. Restoration of service to critical Loads such as:
  - o Military facilities
  - o Facilities necessary to restore the electric utility system
  - o Law enforcement organizations and facilities affecting public health
  - o Communication facilities
5. Maximum utilization of ERCOT System Capability.

6. Utilization of Responsive Reserve Services and other Ancillary Services to the extent permitted by ERCOT System conditions.
7. Utilization of the market to the fullest extent practicable without jeopardizing the reliability of the ERCOT System.
8. Restoration of service to all Customers following major system disturbances, giving priority to the larger group of Customers.

#### 4.5.3 Implementation

ERCOT shall be responsible for monitoring system conditions, initiating the EEA levels below, notifying all Qualified Scheduling Entities (QSEs) and Transmission Operators (TOs), and coordinating the implementation of the EEA conditions while maintaining transmission security limits. QSEs and TOs will notify all the Market Participants they represent of each ERCOT declared EEA level.

ERCOT has the authority to obtain emergency assistance energy over the Direct Current (DC) Tie(s) for use by ERCOT. ERCOT is also the coordinating authority for requests for emergency type power into or out of ERCOT.

ERCOT, at management's discretion, may at any time issue an appeal through the public news media for voluntary energy conservation.

There may be insufficient time to implement all levels in sequence. ERCOT can immediately implement EEA Level 3 any time the system frequency is below 59.8 Hz and will immediately implement EEA Level 3 any time the frequency is below 59.5 Hz.

Percentages for EEA Level 3 Load shedding will be based on the previous year's TDSP peak Load, as reported to ERCOT, and will be reviewed by ERCOT and modified annually.

The ERCOT System Operator shall declare the EEA levels to be taken by QSEs and TDSPs. QSEs and TDSPs shall implement actions under that level (and all above if not previously accomplished) and if ordered by the ERCOT Shift Supervisor or his designate, shall report back to the ERCOT System Operator when the requested level has been completed.

During EEA Level 3, ERCOT must be capable of shedding sufficient firm Load to arrest frequency decay and to prevent generator tripping. The amount of firm Load to be shed may vary depending on ERCOT grid conditions during the event. Each Transmission Service Provider (TSP) will be capable of shedding its allocation of firm Load, without delay. The maximum time for the TSP to interrupt firm Load will depend on how much Load is to be shed and whether the Load is to be interrupted by Supervisory Control and Data Acquisition (SCADA) or by the dispatch of personnel to substations. Since the need for firm Load shed is immediate, interruption by SCADA is preferred. The following requirements apply for an ERCOT instruction to shed firm Load:

- (a) Load interrupted by SCADA will be shed without delay and in a time period not to exceed thirty (30) minutes;
- (b) Load interrupted by dispatch of personnel to substations to manually shed Load will be implemented within a time period not to exceed one (1) hour;



- (c) The initial clock on the firm Load shed shall apply only to Load shed amounts up to 1000 MW total. Load shed amount requests exceeding 1000 MW on the initial clock may take longer to implement; and
- (d) If, after the first Load shed instruction, ERCOT determines that an additional amount of firm Load should be shed, another clock will begin anew. The time frames mentioned above will apply.

Each TSP, or its Designated Agent, will provide ERCOT a status report of Load shed progress within thirty (30) minutes of the time of ERCOT's instruction or upon ERCOT's request.

#### 4.5.3.1 General Procedures Prior to EEA Operations

Prior to declaring EEA Level 1 detailed in Section 4.5.3.3, EEA Levels, ERCOT shall:

- Start Reliability Must-Run (RMR) units available in the time frame of the emergency. RMR units should be loaded to full capability;
- Issue Dispatch Instructions to QSEs to suspend any ongoing ERCOT required generating unit testing;
- Utilize Non-Spin Reserve Services that can be deployed to increase Responsive Reserves;
- ERCOT shall use the Reserve Discount Factor (RDF) for the purpose of monitoring Physical Responsive Capability (PRC). The PRC will be used by ERCOT to determine the appropriate Emergency Notification and EEA levels; and
- In addition, ERCOT may issue an appeal through the public news media for voluntary Load reduction if authorized by the ERCOT Chief Executive Office or its designee based on an evaluation of existing and expected system conditions.

#### 4.5.3.2 General Procedures During EEA Operations

ERCOT Control Area Authority will re-emphasize the following operational practices during EEA operations to minimize non-performance issues that may result from the pressures of the emergency situation.

OPERATOR	EEA ACTION
ERCOT	Suspends Ancillary Service Obligations that it deems to be contrary to reliability needs.
ERCOT	Notify each QSE and TO via hotline of declared EEA level.
QSEs and TOs	Notify each represented Market Participant of declared EEA level.
ERCOT, QSE & TDSP	Continue to respect confidential market sensitive data.
QSEs	Update Resource Plans to limit or remove capacity when unexpected start-up delays occur or when ramp limitations are encountered.
QSEs	Report when On-line or available capacity is at risk due to adverse circumstances.
QSEs and TDSPs and all	Must not suspend efforts toward expeditious compliance

OPERATOR	EEA ACTION
other Entities	with the applicable EEA levels declared by the ERCOT nor initiate any reversals of required actions without ERCOT authorization.
ERCOT	Define procedures for determining the proper redistribution of reserves during EEA operations.

#### 4.5.3.3 EEA Levels

### EEA Level 1 – Maintain ERCOT Physical Responsive Capability (PRC) on Resources plus RRS MW provided from LaaR Equal To 2300 Mw

OPERATOR	ACTION
ERCOT	<ul style="list-style-type: none"> <li>o Utilize available DC Tie capability that is not already being used by the market.</li> <li>o Notify the Southwest Power Pool Security Coordinator.</li> <li>o Issue OOM dispatch instructions to uncommitted units available within the expected timeframe of the emergency.</li> <li>o Inquire about availability of Block Load Transfers.</li> </ul>
QSE	<ul style="list-style-type: none"> <li>o Notify ERCOT of any Resources uncommitted but available in the timeframe of the emergency.</li> <li>o Immediately update the HSL of any On-line Resource that is capable of providing extra capacity within thirty (30) minutes. The extra capacity must already be part of the QSE's Up Balancing bid curve in order for SPD to utilize the updated Resource Plan.</li> </ul>

### EEA Level 2A – Maintain ERCOT Physical Responsive Capability (PRC) on Resources plus RRS MW Provided from LaaR Equal To 1750 MW

OPERATOR	ACTION
	<b>In addition to measures associated with EEA Level 1</b>
ERCOT	<ul style="list-style-type: none"> <li>o Instruct TDSPs to reduce Customers' Load by using distribution voltage reduction measures, if deemed beneficial by the TDSP.</li> <li>o Instruct QSEs to deploy all Responsive Reserve, which is supplied from Load acting as a Resource (LaaRs) (controlled by high-set under-frequency relays)</li> <li>o With approval of the affected Non-ERCOT control</li> </ul>

OPERATOR	ACTION
	<p>area, may instruct TDSPs to implement Block Load Transfers (BLTs), which transfer Load from the ERCOT control area to Non-ERCOT control areas.</p> <ul style="list-style-type: none"> <li>o Unless such a media appeal is already in effect, ERCOT staff shall issue an appeal through the public news media for voluntary energy conservation.</li> </ul>

### EEA Level 2B - Maintain System Frequency At 60 Hz

OPERATOR	ACTION
	<p>Following deployment of the measures under EEA Levels 1 and 2A.</p>
ERCOT	<p>Deploy all available EILS Resources as a single block via a single Verbal Dispatch Instruction to all QSEs providing EILS.</p>

### EEA Level 3 - Maintain System Frequency At 59.8 Hz Or Greater

OPERATOR	ACTION
	<p>In addition to measures under EEA Levels 1, 2A and 2B.</p>
ERCOT	<p>Direct all TDSPs and their agents to shed firm Load, in one hundred (100) megawatt (MW) blocks, distributed as agreed and documented in the ERCOT Operation procedures in order to maintain a steady state system frequency of 59.8 Hertz (Hz). ERCOT may take this action prior to the expiration of the ten (10) minute EILS Resource deployment period if ERCOT, in its sole discretion, believes that shedding firm Load is necessary to maintain the stability of the ERCOT System. If, due to ERCOT System conditions, EILS Resources are not deployed prior to this action, ERCOT shall deploy EILS Resources as soon as possible following this action.</p>
	<p>In addition to measures under EEA Levels 1, 2A and 2B.</p>
TDSPs	<p>Keep in mind the need to protect the safety and health of the community and the essential human needs of the citizens. Whenever possible, TDSPs shall not manually drop Load connected to under-frequency relays during the implementation of the Energy Emergency Alert.</p>

Obligation for Load shed is by DSP. Load shedding obligations need to be represented by an Entity with 7x24 operations and hotline communications with ERCOT and control over breakers. [Use Transmission Operators (TOs) as list of Entities.]

ERCOT Load Shed Table

<b>Transmission Operator</b>	<b>2008 Total Transmission Operator Load (MW)</b>
American Electric Power	8.79
Austin Energy	4.04
Brazos Electric Power Cooperative	4.50
CenterPoint Energy	24.57
City of Bryan	0.55
City of College Station	0.29
City of Denton	0.50
City of Garland	0.96
CPS Energy	7.11
Lower Colorado River Authority	5.33
Magic Valley Electric Cooperative	0.57
Oncor	38.28
Public Utility Board of Brownsville	0.41
Rayburn Country Electric Cooperative	1.08
South Texas Electric Coop-Medina Electric Coop	0.63
Texas New Mexico Power	2.24
Tex-La	0.15
<b>ERCOT Total</b>	<b>100.00</b>

#### 4.5.3.4 EEA Termination

ERCOT shall continue EEA until sufficient bids are received by ERCOT to eliminate the shortfall and restore adequate reserves.

<b>OPERATOR</b>	<b>ACTION</b>
ERCOT	Restore full reserve requirements (normally 2300 MW) Terminate the levels in reverse order, where practical. Notify each QSE and TO of EEA level termination.
QSEs and TOs	<ol style="list-style-type: none"> <li>a. Implement actions to terminate previous actions as EEA levels are released in accordance with these guides.</li> <li>b. Notify represented Market Participants of EEA level changes.</li> <li>c. Report back to the ERCOT System Operator when each level is accomplished.</li> <li>d. Loads will be restored when specifically authorized by the ERCOT.</li> </ol>

ERCOT shall maintain a stable ERCOT System frequency when restoring Load.

## 4.6 Black Start

This section provides general philosophies to be followed in the event of a partial or complete collapse of the ERCOT system. Timely implementation of a restoration plan compiled according to this guide should facilitate coordination between ERCOT, QSEs, PGCs, and TOs and ensure restoration of service to the ERCOT System at the earliest possible time. Those QSEs representing contracted Black Start Units will provide ERCOT with the individual plant start-up procedures for coordination of their activities with those of the appropriate TO.

Pre-established plans and procedures cannot foresee all the possible combinations of system problems that may occur after a major failure. It is then the responsibility of ERCOT to restore the system to normal, applying the principles, strategies, and priorities outlined in this section and in The ERCOT Black Start Plan.

**REFERENCE: PROTOCOL SECTION 22A, STANDARD FORM BLACK START AGREEMENT (IN PART)**

...Section 8. Operation.

...C. Delivery.

...(2) *If the ERCOT Transmission Grid at the Black Start Resource becomes deenergized and if Participant cannot communicate with either ERCOT or the TDSP serving the Black Start Resource, then Participant shall follow the procedures specified for the Black Start Resource under ERCOT's Black Start Plan in the Operating Guides, but Participant shall not commence delivering electric energy into the ERCOT System without specific instructions to do so from either ERCOT or the TDSP serving the Black Start Resource.*

Section 9. Payment.

B. Hourly Standby Fee Payments.

(1) Availability

- (a) *"Available" means, with respect to a given hour, that; Participant has declared, in its Availability Plan, that the Black Start Resource is able to start without a connection to the ERCOT Transmission Grid.*
- (b) *The Black Start Resource is not "Available" if:*
  - (i) *the Black Start Resource utilizes a power pool outside of ERCOT to start and the transmission path(s) between the Resource and the other power pool is not available due to an outage; or*
  - (ii) *the Black Start Resource utilizes a power pool outside of ERCOT to start but fails to maintain a firm standby supply contract for that power pool; or*
  - (iii) *the Black Start Resource has failed a black start test, as described in the ERCOT Protocols or Operating Guides and has not passed a subsequent black start test; or*
  - (iv) *the Black Start Resource has failed to start when required under this Agreement, and it has not passed a subsequent black start test.*

- (c) *At its option, ERCOT may use the Black Start unit's Resource Plan as the source of Black Start availability information instead of the Availability Plan...*

#### **4.6.1 Principles**

In order to minimize the time required, ERCOT will coordinate the restoration utilizing the principles, strategies, and priorities outlined in this guide.

ERCOT shall establish and maintain a system black start capability plan that shall be coordinated, as appropriate, with the black start capability plans of neighboring Regions. Documentation of system black start capability plans shall be provided to NERC on request. (NERC Planning Standards)

Each contracted Black Start Unit and each QSE with contracted Black Start Unit(s) will have readily accessible and sufficiently detailed current operating procedures to assist in an orderly recovery.

Mutual assistance and cooperation will be essential during the restoration. Deliberate, careful action by each QSE, TO, and PGC is necessary to minimize the length of time required for restoration and to avoid the reoccurrence of a partial or complete collapse.

Throughout the restoration, recovery will depend on ERCOT receiving an accurate assessment of system conditions and status from each QSE, TO, and PGC throughout the restoration. Adequate and reliable communications must be available within the ERCOT System. During Black Start Recovery, communication restrictions are lifted to enable the sharing of only that information that pertains to reliability including status information and recovery activities.

#### **4.6.2 Strategies**

In the event of a partial or complete system blackout, immediate steps must be taken to return the interconnected network to normal as quickly as possible.

Each TO shall immediately initiate its portion of the Black Start procedure and attempt to establish contact with ERCOT. If communications with ERCOT are unavailable the TO shall immediately establish communications with its interconnected Black Start Unit(s) and the Black Start Unit's QSE.

Each QSE with representing Black Start Units should initiate communications with its Black Start Units and immediately notify ERCOT and the appropriate TO of their condition and status.

Available Black start units should immediately start their isolation and startup procedures and attempt to establish communications with the local TO.

As generating and transmission capabilities become available, systematic restoration of ERCOT Load with respect to priorities should begin in accordance with the local TO Black

Start Plans, taking care to balance Load and generating capability while maintaining an acceptable frequency.

Appropriate voltage levels and reactive control must be maintained during the restoration. Consideration should be given to connecting islands at locations having communications, frequency control, voltage control, synchronization facilities, and adequate transmission capacity. ERCOT will coordinate the return to full Automatic Generation Control in the interconnection.

#### 4.6.3 Priorities

Priorities for an ERCOT system restart are listed below:

- a. Secure and/or stabilize generating units where necessary.
- b. Prepare transmission corridors as necessary to support restoration.
- c. Assess ERCOT system condition, and available communication facilities.
- d. Restore and maintain communication facilities to the extent possible.
- e. Bring units with contracted black start capability on-line.
- f. Provide service to critical facilities:
  - o Provide station service for nuclear generating facilities.
  - o Provide critical power to as many power plants as possible to prevent equipment damage.
  - o Secure or provide startup power for generating plants that do not have black start capability.
  - o Supply station service to critical substations where necessary.
- g. Connect islands at designated synchronization points taking care to avoid recurrence of a partial or complete system collapse.
- h. Restore service to critical Loads such as:
  - o Military facilities.
  - o Facilities necessary to restore the electric utility system, including fuel sources.
  - o Law enforcement organizations and facilities affecting public health.
  - o Public communication facilities.
- i. Restore service to the remaining Customers. Attention should be given to restoring feeders with under-frequency relay protection.

#### 4.6.4 Responsibilities

OPERATOR	ACTION
ERCOT	<ol style="list-style-type: none"> <li>1. Shall maintain a Black Start Plan in accordance with NERC Policies, Procedures and standards.</li> <li>2. Coordinate and approve Planned Outage schedule for</li> </ol>

OPERATOR	ACTION
	<p>contracted Black Start Units.</p> <p>3. Train QSE, TO, PGC, and Market Participant personnel in the implementation and use of the Black Start Plan.</p> <p>4. In the event of an ERCOT System collapse, ERCOT will:</p> <ul style="list-style-type: none"> <li>o Maintain continuous surveillance of the status of the ERCOT System</li> <li>o Act as a central information collection and dissemination point for the region</li> <li>o Coordinate reconnection of transmission</li> <li>o Direct assistance for QSEs, TOs, PGCs, and Market Participants.</li> <li>o Direct the distribution of reserve.</li> <li>o Coordinate the return of the ERCOT System to Automatic Generation Control.</li> </ul>
Transmission Operators	<p>5. Shall maintain a local Black Start Plan which coordinates with the ERCOT Black Start Plan</p> <p>6. In event of an ERCOT or wide area blackout:</p> <ul style="list-style-type: none"> <li>o Shall communicate with local Black Start Units and the Black Start Unit's QSE.</li> <li>o Coordinate switching to next start units and local Load.</li> <li>o Shall implement its local Black Start Plan.</li> <li>o Shall follow the direction of ERCOT on behalf of represented TDSPs.</li> <li>o Shall act as the regional ERCOT representative in coordinating interconnection of units</li> <li>o Shall follow the direction of ERCOT for reconnection of islands.</li> </ul>
QSEs, PGCs, and Market Participants	<p>7. Shall use the ERCOT and local TO Black Start Plan</p> <p>8. Verify that associated personnel are proficient in its implementation and use.</p> <p>9. In the event of an ERCOT System collapse, the QSEs, PGCs, and Market Participants will:</p> <ul style="list-style-type: none"> <li>o Take immediate steps to initiate the local Black Start Plan.</li> <li>o Supply ERCOT and/or the local TO with information on the status of generation, fuel, transmission, and communication facilities.</li> <li>o Follow the direction of the local TO or ERCOT in picking up local Load and starting next units.</li> <li>o Provide available assistance as directed by ERCOT or the local TO.</li> </ul>



Attachment 4A provides a detailed and specific Black Start information guide. Interested parties should use this information for technical reference material, Black Start Testing, development of Black Start Plans, and training of personnel.

#### **4.6.5 Emergency Back Up Communication Facilities Criteria**

***REFERENCE: PROTOCOL SECTION 6.4.2, DETERMINATION OF ERCOT CONTROL AREA REQUIREMENTS (IN PART)***

- ...(7) *Black Start Service: ERCOT shall periodically determine and review the location and number of Black Start Resources required, as well as any special transmission or voice communication needs required. ERCOT and providers of this service shall meet the requirements as specified in the Operating Guides and in NERC policy.*
- (1) All back up communications systems shall meet the following minimum requirements:
    - (a) Be operational for seventy-two (72) hours immediately following the start of a blackout without external power from the ERCOT grid;
    - (b) Provide direct voice communications between: Black Start Resource and TO; TOs and appropriate TOs; TOs and ERCOT; and,
    - (c) Have written procedures that address operator training and the testing of the communication system.
  - (2) TOs shall have a satellite phone that meets the minimum back up communication requirements as a back up communication system and that is compatible with ERCOT's satellite phone.

## 4.7 Document Control

### *Change History*

<b>Issue/Date</b>	<b>Reason for issue</b>
Version 1.0 February 28, 2001	Updated from Working Group comments. Submitted to Technical Advisory Committee to approve handover to the Reliability Operating Subcommittee
Version 1.1 April 10, 2001	Added specific language for actions during Pilot Program to EECF Steps (4.5.3.2) and Black Start (4.6)
April 17, 2001	Clarified use of Ancillary Service resources in Step 1 of EECF
October 1, 2002	OGRR112
December 1, 2002	Corrected typos.
January 1, 2003	OGRR111 modified EECF Steps 1-4. OGRR118 revised Black Start text in Section 4.6 and Attachment 4A.
April 1, 2003	OGRR122 revised Sections 4.5 & 4.5.3.2 to include update made to EECF Step 1 amended by Protocols, PRR332.
May 1, 2003	Updated reference to Protocols 22A due to PRR380 – Black Start.
September 1, 2003	OGRR129 updated Sections 4.1, 4.2.2, 4.2.3, 4.5.3, 4.5.3.1, 4.5.3.3, & 4.6.4.
January 1, 2004	OGRR139 added Section 4.6.5 and updated Attachment 4A.1
February 1, 2004	OGRR140 added Section 4.3.1
June 1, 2004	Updated Load Shed Table in Section 4.5.3.2
September 1, 2004	OGRR147 updated Sections 4.2.1, 4.2.2, and 4.2.4.
June 1, 2005	Admin OGRR168 (includes Load Shed Table in Section 4.5.3.2)
September 1, 2005	OGRR166
April 1, 2006	OGRR174, Admin OGRR183
June 1, 2006	Admin OGRR185
December 1, 2006	OGRR186, OGRR187
January 1, 2007	Admin OGRR189
February 1, 2007	Admin OGRR190
June 1, 2007	Admin OGRR199
June 7, 2007	OGRR196
July 1, 2007	Admin OGRR201
March 1, 2008	OGRR206
May 1, 2008	Admin OGRR207
June 1, 2008	Admin OGRR209, Admin OGRR210
October 1, 2008	OGRR211
February 1, 2009	OGRR212

<b>Issue/Date</b>	<b>Reason for issue</b>
March 1, 2009	OGRR213
April 1, 2009	OGRR221
May 1, 2009	OGRR213 (unboxed due to effective date)
June 1, 2009	Admin OGRR227, Admin OGRR228

## Attachment 4A: Detailed Black Start Information

The following attachment provides detailed and specific information to be used in conjunction with the ERCOT Black Start Plan. Each TO, QSE, and Generator should use this information for technical reference, development of Black Start Plans, and training of personnel.

### 4A.1 CONSIDERATIONS FOR SYSTEM RESTORATION

#### a. Determining System Status

If a Generator or TO loses voltage on all busses and incoming transmission lines, then operators should assume there is a system wide blackout. The TO should immediately notify ERCOT if possible. Contracted Black Start units should implement Black Start procedures and establish contact with their TO. Other Generators should contact their QSE and then wait for instructions from the TO. If possible, ERCOT will update TOs and QSEs concerning ERCOT system status by use of the hotline.

**It is expected that if communication with ERCOT is not possible TOs will evaluate system conditions and proceed independently with their Black Start Plans if needed.**

Priority should be given to determining the status of nuclear power plant facilities and switchyards in order to re-establish offsite power supply.

System status conditions to be surveyed include but are not limited to:

- Areas of the system that are de-energized.
- Areas of the system that are functioning.
- Amount of generating reserve available in functioning areas.
- Power plant availability and time required to restart.
- Status of transmission breakers and sectionalizing equipment along critical transmission corridors, and at power plants.
- Status of transmission breakers and sectionalizing equipment at tie points to other areas.
- Status of fuel supply from external suppliers.
- Under-frequency relay operation.
- Relay flags associated with circuits tripped by protective relays.

#### b. Verifying Communications

Reliable communications will be the key to a safe and timely restoration following a collapse within the ERCOT System. As part of the initial assessment after a partial or complete system collapse, communication facilities should be tested and verified. It is possible, especially in case of a total ERCOT collapse, that communications with out-of-state QSEs may not be possible. It is therefore critical that TOs and Generators located within their transmission system be able to communicate directly during these times.

The ERCOT System Operators should:

- Verify or establish communication paths with TOs.
- Verify or establish communications paths with QSEs.
- Verify integrity of ERCOT hotline.
- Periodically disseminate information to TOs and QSEs.

The TO operators should:

- Contact ERCOT in order to report status.
- Establish contact with Contracted Black Start Units and the Black Start Units' QSE
- Initiate Black Start Plan
- Establish communication paths with other plants necessary to the restoration of the system in their area.

The QSE should:

- Contact ERCOT to report status of Generators within ERCOT
- Assist TOs as required.
- Ensure Generators are prepared to receive and follow instructions directly from the TO to which they are connected.

Should problems be encountered with any of the primary communication facilities, back up facilities shall be deployed and appropriate personnel notified.

Communications will be vital to an orderly recovery. To keep communication facilities available, operating personnel should ensure that conversations are concise and effective.

**c. Preparing for System Restoration**

Orderly restoration will usually require sectionalizing the de-energized parts of the system into smaller, manageable blocks before they are energized.

The sectionalizing process should usually address the following objectives:

- Priority should be given to restoring offsite power to nuclear power plants.
- Make blocks of Load to be energized as small as possible to minimize the problems of cold Load pickup.
- Operators should verify that their switching orders as well as any standing emergency switching orders have been completed.

**d. Bringing Up Plants**

First priority should be given to preventing damage to power plant equipment and to restoring offsite power to nuclear power plants. Secondly, attention should be given to preparing units that can come on line most rapidly. All operators should remember that large steam plants will need an outlet for the minimum generation requirement soon after coming on line.

Plants with contracted Black Start capability have procedures to begin the process of bringing their units back up when the switchyard and all incoming transmission lines are de-energized. The plant should not synchronize or pickup Load without communicating with the TO to which they are connected unless their local Black Start Plan instructs them to do so.

Plants without Black Start capability should have a Black Start Plan in place to begin preparing the plant to be energized from an external line. When the TO has energized the plant switchyard it will contact the Generator directly and the QSE as soon as practical. The TO will coordinate the starting of large motors, bringing the plant on line, and synchronization of the plant with the rest of the TO island.

Some combustion and steam turbines may have relatively high set under-frequency and low over-frequency relays that could cause unit trips in the initial stages of recovery. Plant operators will be controlling system frequency during this period and must keep it between trip points. It is preferable to use the units with lowest under-speed trip for initial restoration.

Automatic voltage regulators should be placed in service as soon as practical after bringing units on line and should remain in service to improve machine stability.

As soon as possible, after bringing a unit on line, automatic governor controls should be placed in the "automatic" position to insure instantaneous governor response to changes in Load.

**e. Picking Up Lines**

Ties between nearby power plants should be established as soon as possible. Priority should be given to restoring at least one circuit to nuclear power plants to provide offsite power for safe shutdown.

A line should be energized from the strongest electrical source. Switching devices on all substation or transmission capacitor banks along the line should be open unless needed for voltage control.

Energizing transmission auto-transformers (345/138 kV, 138/69 kV) and shunt reactors at plants will allow plant operators to increase field current on the Generator to increase stability. Also, this reactive current will help keep transmission voltages from becoming excessive.

Caution should be exercised in the use of 345 kV transmission system. Because of high values of line charging, energizing one of these circuits with little or no Load can produce excessive voltage and can damage substation equipment (Note: 345KV lines require approximately 1 MVAR/mile of line charging while 138KV lines require 0.3 MVAR/mile).

TO Operators should exercise care when energizing transmission lines, so that they do not close a breaker into a fault. TO Operators should be aware of any transmission lines that tripped while the system was going down and have field personnel check the relay flags before energizing the line.

Ferroresonance may occur while energizing a line or while picking up a transformer from an unloaded line. TO Operators should be on guard for unusually high and sustained voltages during such switching. 345 kV lines may be highly susceptible to this phenomenon and their use should be minimized in the early stages of restoration.

Impedance relays that do not have out of step blocking may trip lines due to power swings during restoration (a good indication that the line tripped due to excessive power swings rather than a fault is the existence of impedance relay flags and no ground flags).

**f. Picking Up Load**

In general, 69 kV and 138 kV lines along with radial 345 kV lines to autotransformers may be used to energize Load. When energizing a 345 kV circuit and autotransformer combination, both the line and transformer should be energized at the same time to avoid the problem of excessive voltage. The more lightly loaded a unit is, the less Load increment it can safely pick up.

Cold Load pickup can involve inrush currents of 10 or more times the normal Load current depending on the nature of the Load being picked up. This will generally decay to about two times normal Load current in two to four seconds and remain at a level of 150 to 200% of pre-shutdown levels for as long as thirty minutes.

Priority should be given to restoring offsite power to nuclear power plants. As critical and priority Loads are restored, consideration should be given to restoration of Loads controlled by under-frequency relays.

When energizing Load, the TO Operators must be in close contact with the Generator in order that excessive Load is not picked up on a unit in one operation. Generally, pick up no more than 5% of the total generating capability in an island in a single step. If Load is picked up in blocks that are too large, then the current inrush may operate over current relays that trip the Loads off the system again. There should be sufficient time between switching operations to allow the units to recover from the sudden increase in Load.

Exercise caution when loading a single unit to more than 50% of its control range until additional units have been brought back on-line in that island. Generally, no unit should be loaded to more than 80% of its normal rating until system conditions return to normal.

Since each plant may be operating independently, plant operators will have to monitor and adjust their unit's voltage and frequency. Frequency should be kept above 59.8 Hz and as close as possible to 60 Hz. Voltage should be kept as close as possible to normal schedules. As more units are brought up and more Load is added, the voltage and frequency will tend to stabilize.

Residential and commercial Load will most likely be easier to pick up and maintain than industrial Loads. This is due to the large fluctuation possible with industrial Loads.

Exercise caution when re-energizing capacitor banks after Load has been picked up. The change in system voltage that occurs will be much larger than normal because of the reduced system fault duty.

**g. Synchronizing Between Islands**

TOs should have field personnel in area islands to check breakers at each end of the line to insure they are open regardless of supervisory indication. The area with the largest amount of generation on-line should energize the line first.

Where available, field personnel should synchronize and close the tie breakers at the point of interconnection. If there is a sufficient frequency difference that the islands cannot be synchronized, the island with the least generation on-line should adjust its frequency to achieve synchronization.

When synchronizing, both the phase angle across the breaker, and the voltage on each side of the breaker should be measured. If possible, the phase rotation should be stopped and the phase angle reduced to 10 degrees or less before closing the breakers.

In general lines should not be loaded to more than 50% of thermal rating until multiple tie paths have been established. Additional ties should be closed as soon as possible.

**4A.2 ERCOT COORDINATION**

During the initial stages of the restoration ERCOT will coordinate the Black Start restoration effort by monitoring the implementation of each TO's Black Start Plan, providing system status information, and facilitating communication between market participants. ERCOT will also monitor the changes in generation conditions, restoration of transmission lines, and any Load that is re-energized. The ERCOT hotline will periodically be used to communicate simultaneously with the market participants on a periodic basis assuming communication is possible.

System status conditions, which should be surveyed, include but are not limited to:

- Communication Facilities
- Transmission System
- Generating System
- Fuel Supplies
- Any significant conditions which might affect restoration

ERCOT System Operators should be sure that each TO and Generator is successfully implementing its Black Start Plan. ERCOT System Operators will direct mutual assistance by utilizing the Black Start map and contacting the Market Participants most able to provide the assistance.

Before synchronization of inter-company islands ERCOT will designate what entity is responsible for frequency control in the combined islands. Initially this may be a single plant. As the restoration effort progresses, ERCOT will work to combine islands in such a way as to restore frequency control of one of the QSEs. As inter-company islands are synchronized ERCOT will approve the addition of generation and Load to the system. No additions should be made without that approval.



### 4A.3 Considerations For Black Start Testing

As prescribed by the ERCOT Protocols, testing must be performed to qualify black start resources.

ERCOT shall maintain a record of black start generators within ERCOT and update such records on an annual basis. The record shall include the name, location, MW capability, type of unit, date of test, and starting method of each Black Start Unit. (NERC Planning and Reliability Standards) A current Black Start Unit Test Results Form will be provided with the RFP for Black Start Service distributed by ERCOT.

The owner or operator of each Black Start Unit shall demonstrate through the testing procedures outlined in Protocol Section 6.10.3.6, System Black Start Capability, that the unit can perform its intended functions as required in the system restoration plan. ERCOT may also order random simulation or testing of black start capabilities as described in Protocol Section 6.5.8, Black Start Service. Documentation of the analysis shall be provided to NERC on request. (NERC Planning Standards)

The results of the testing of the startup and operation of each Black Start Unit shall be documented and provided to NERC on request. (NERC Planning and Reliability Standards)

### 4A.4 Criteria for ERCOT and Transmission Operator Black Start Plans

ERCOT will maintain a Black Start Plan that is consistent with this Guide. All plans and procedures shall be readily available to the System Operators and copies of appropriate plans shall be provided to the QSEs, TOs, and PGCs.

ERCOT System Operators should review these documents on a regular basis. It is suggested that the ERCOT Black Start Plan include the following elements:

- (1) Strategies and philosophies for ERCOT restart.
- (2) Identification of the relationships and responsibilities of the QSEs, TOs, and market participant's personnel necessary to the restoration.
- (3) Identification of Black Start resources including:
  - Unit resources.
  - Transmission resources.
  - Communication resources.
  - Fuel resources.
- (4) Mutual assistance arrangements.
- (5) Contingency plans for failed resources.
- (6) Identification of critical Load requirements
- (7) Identification of special equipment requirements
- (8) General instructions and guidelines for ERCOT System Operators, PGC, QSE, and TO operators and their respective communications personnel.

- (9) Procedures for Public Notification.
- (10) Procedures for return to Market Operations.

When incorporated into the general instructions and guidelines for the ERCOT System Operators, the elements listed above will supply a broad background of information available for use to effectively recover from a major ERCOT System collapse. These elements will also help to identify common problems facing the ERCOT System during restoration. It is essential that all appropriate personnel be familiar with these plans and procedures so that the ERCOT System can be restored to normal as quickly as possible.

**Transmission Operators** shall maintain a local Black Start Plan that is coordinated with the ERCOT Black Start Plan, but provides additional local detail. The TO Black Start Plan should include sections on the Black Start scope, communication process, and operations as outlined below.

A **SCOPE** section shall provide the main objectives, responsibilities, and expected actions of the TO and other market entities in the event of system blackout. This section should address at least the following items:

- a. Roles and Responsibilities
  - TO plan should identify its role as well as those of generating resources and ERCOT in the case of a blackout.
- b. Identifying the blackout event
  - TO plan should clearly state how a blackout event will be recognized and what actions the TO operator needs to initiate restoration as well as what actions should be expected from ERCOT and other market participants.
- c. Assessing and verifying communication capabilities
  - TO plan should include a procedure for assessing communication capabilities and a plan for dealing with failures of various systems.
- d. Transferring control away from ERCOT
  - In the event of a blackout, the TO will have ERCOT's authority to bring units on line and energize Load. The TO should note that it may not be possible for ERCOT to communicate this transfer of authority and that the transfer can be assumed once a blackout condition has been identified.
- e. Starting the Black Start Units
  - The TO plan should primarily rely on contracted Black Start Units in restoring the system. However, the TO plan should also account for non-contracted Black Start Unit capabilities and incorporate these resources if possible.
- f. Building Stable Island(s)

The primary focus of TO plan should be on building stable islands with the ultimate goal of reaching synchronization points. TO plans should also consider that while larger islands are more stable they might be more difficult to synchronize with neighboring islands.

g. Reaching synchronization points

The TO plan should focus on restoring the system and not restoring service to Customers. The primary focus of the TO plan should be on building a stable island that reaches a designated synchronization point.

h. Synchronizing islands

The TO plan should instruct operators to contact ERCOT when islands are ready to be synchronized. Actual synchronization will occur with TOS communicating directly with each other. ERCOT will coordinate frequency control. For intra-company islands the plan should contain instructions for adding Load and generation.

j. Restoring Load after synchronization

TO plans should note that after synchronization occurs between islands, ERCOT will direct the further addition of Load and generation. The TO will continue to add Load, but it will be at the direction of ERCOT as specified in the Strategy section of this plan.

A **COMMUNICATIONS** section should address at least the following items:

- a. ERCOT contact information
- b. List of contracted Black Start Units
  - Plant and QSE contact information and location within system
- c. List of non-contracted Black Start Units native to Black Start Plan.
  - Plant and QSE contact information an location within system
- d. List of additional generating plants native to Black Start Plan
  - Plant and QSE contact information and location within system
  - Startup characteristics of each plant.
- e. List and location of neighboring TOs
  - Contact information and tie points within the system

An **OPERATIONS** section should address at least the following items. A subsection for operations of each island also be included in the TO plan.

- a. Black Start Unit
  - Unit startup and Load pickup procedure
- b. Next start units
  - Unit startup and Load pickup procedure

- c. Loads
  - Critical Loads in each island
- d. Transmission paths
  - Switching procedures for primary transmission corridor
  - Switching procedure for secondary transmission corridor
  - One line diagram of primary and secondary corridor from Black Start Unit to synchronization points
  - Special considerations or procedures for switching lines belonging to another TO.
- e. Synchronization points
  - Location and ownership of each synchronization point
  - Synchronization procedures and special requirements for each location

ERCOT will review the plans and procedures for consistency and conformance with this guide and ensure that they are updated at least annually. ERCOT will make annual reports during the first quarter to the Reliability and Operations Subcommittee of plan review and any testing activities of black start resources. ERCOT shall verify that the number, size, and location of system Black Start Units are sufficient to meet system restoration plan expectations. (NERC Planning and Reliability Standards)

---

---

# ***ERCOT OPERATING GUIDES***

---

---

## Section 5: Planning

---

---

July 1, 2007

**PUBLIC**

# Contents

<b>5</b>	<b>PLANNING .....</b>	<b>5-3</b>
5.1	PLANNING CRITERIA .....	5-3
5.1.1	<i>Introduction.....</i>	5-3
5.1.2	<i>Load Forecasts.....</i>	5-4
5.1.3	<i>Resource Capability.....</i>	5-4
5.1.4	<i>Transmission Reliability Testing.....</i>	5-4
5.1.5	<i>Reports Of Testing .....</i>	5-6
5.1.6	<i>System Modeling Information.....</i>	5-6
5.1.7	<i>ERCOT Clarifications and Definitions of NERC Planning Standards Contingency Types C and D.....</i>	5-12
5.2	DOCUMENT CONTROL.....	5-14

## **5 Planning**

### **5.1 Planning Criteria**

#### **5.1.1 Introduction**

The Electric Reliability Council of Texas (ERCOT) power system consists of those generation and Transmission Facilities (60 kV and higher voltages) which are controlled by individual ERCOT Market Participants and which function as part of an integrated and coordinated power supply network. Each reference in this document to ERCOT Market Participants includes Generation Resources (GRs), Qualified Scheduling Entities (QSEs), Competitive Retailers (CRs), Transmission/Distribution Service Providers (TDSPs), and other that use the transmission system.

In order to maintain reliable operation of the ERCOT power system, it is necessary that all ERCOT Market Participants observe and subscribe to certain minimum planning criteria. The criteria set forth herein, combined with the NERC Planning and Reliability Standards, constitute these minimum-planning criteria. Tests outlined herein shall be performed to determine conformance to these minimum criteria; however, because ERCOT recognizes that events more severe than those outlined in these criteria could cause separation, other tests may also be performed if necessary for information purposes.

The complexity and uncertainty inherent in the planning and operation of the ERCOT power system make exhaustive testing impracticable; therefore, to gain maximum benefit from the limited number of tests which are performed, the selection of the specific tests and the frequency of their performance will be made solely upon the basis of the expected value of the reliability information obtainable from the test.

It is the responsibility of each ERCOT TDSP to perform tests appropriate to ensure the reliability of its own Transmission Facilities, and to recommend for further study by the ERCOT System Planning Function (SPF) or the ERCOT Reliability Operations Subcommittee (ROS) tests, which examine effects of importance to multiple ERCOT TDSPs or the ERCOT power system. Upon consideration of such recommendations, the ERCOT SPF and the ERCOT ROS shall coordinate the performance of tests as necessary to assess the reliability of the planned ERCOT power system.

ERCOT (Regional Planning Groups or Transmission Planning) shall determine and demonstrate the need for any static and/or dynamic Reactive Power capability in excess of the explicit requirements of the Protocols and Operating Guide that is necessary to ensure compliance with the ERCOT Planning Criteria, and ERCOT (Transmission Planning) shall establish specific TSP responsibility for any associated facility additions.

The ERCOT SPF, in cooperation with the ERCOT Compliance Office, will review the ERCOT Planning Criteria every three years to ensure it meets the requirements in the NERC Planning and Reliability Standards. The ERCOT SPF, in cooperation with the ERCOT Compliance Office, will periodically review the planning criteria, procedures, and practices of individual ERCOT TDSPs to insure consistency with NERC and ERCOT criteria.

### 5.1.2 Load Forecasts

Each ERCOT DSP directly interconnected with the transmission system (or its agent so designated to ERCOT) shall provide annual Load forecasts to the ERCOT SPF as outlined in the ERCOT Annual Load Data Request (ALDR) Procedures. For each substation not owned by either a TSP or a DSP, the owner shall provide a substation Load forecast to the directly-connected TDSP sufficient to allow it to adequately include that substation in its ALDR response.

### 5.1.3 Resource Capability

ERCOT will periodically determine the minimum reserve margin required to ensure the adequacy of installed generation capability in ERCOT. ERCOT or the Public Utility Commission of Texas may also approve specific Market Participant requirements to ensure that the required minimum reserve margin is maintained.

The ERCOT SPF maintains a database containing existing and proposed generating capability historical and projected values for demand and energy; and proposed major transmission system additions. This database is updated periodically and the Capacity Demand Reserve (CDR) Working Paper is produced annually.

### 5.1.4 Transmission Reliability Testing

The interconnection philosophy of ERCOT is to minimize loss of Load by remaining interconnected. Interconnected system planning will include steady state and dynamic simulated testing by ERCOT TDSPs and the ERCOT SPF to represent specific occurrences for each type of contingency specified below or listed in Table I of the NERC Planning and Reliability Standards. Table I of the NERC Planning and Reliability Standards is included in this document for reference. The term “generating unit”, as used in Table I below, for the purpose of reliability testing shall be defined as the largest single generating unit operating at a given voltage level at each plant location. In the case of a Combined Cycle Facility, the term “generating unit”, as used in Table I below, shall be defined as the total generating capacity of the entire train. Also included are ‘ERCOT Clarifications and Definitions’ which are applicable to testing for NERC Planning Standards contingency types C and D.

The contingency tests will be performed for reasonable variations of Load level, generation schedules, planned transmission line Maintenance Outages, and anticipated power transfers. At a minimum, this should include projected loads for the upcoming summer and winter seasons and a five-year planning horizon. The ERCOT TDSPs involved should plan to resolve any unacceptable test results through the provision of Transmission Facilities, the temporary alteration of operating procedures (Remedial Action Plans), temporary Special Protection Systems, or other means as appropriate.

While the requirements listed in Table I address most ERCOT planning concerns, tests will also be conducted to ensure that the planned system conforms to the following additional requirements:

1. The contingency loss of a double-circuit transmission line that exceeds 0.5 miles in length (either without a fault or subsequent to a normally-cleared non-three-phase fault) with all other facilities normal should not cause a) cascading or uncontrolled outages, b) instability of generating units at multiple plant locations, or c) interruption of service to firm demand or generation other than that isolated by the double-circuit loss, following the execution of all



automatic operating actions such as relaying and special protection systems. Furthermore, the loss should result in no damage to or failure of equipment and, following the execution of specific non-automatic predefined operator-directed actions (i.e., Remedial Action Plans), such as generation schedule changes or curtailment of interruptible Load, should not result in applicable voltage or thermal ratings being exceeded.

2. With any single generating unit unavailable, and with any other generation preemptively redispatched, the contingency loss of a single transmission element (either without a fault or subsequent to a normally-cleared non-three-phase fault) with all other facilities normal should not cause a) cascading or uncontrolled outages, b) instability of generating units at multiple plant locations, or c) interruption of service to firm demand or generation other than that isolated by the transmission element, following the execution of all automatic operating actions such as relaying and special protection systems. Furthermore, the loss should result in no damage to or failure of equipment and, following the execution of specific non-automatic predefined operator-directed actions (i.e., Remedial Action Plans) such as generation schedule changes or curtailment of interruptible Load, should not result in applicable voltage or thermal ratings being exceeded.

With regard to (2) above, the term “single generating unit” experiencing a forced outage shall be defined as the largest single generating unit operating at a given voltage level at each plant location. In the case of a Combined Cycle Facility, a “single generating unit” experiencing a forced outage shall be defined as the entire train unless the combustion turbine and the steam turbine can operate separately, as stated in the Generation Resource Asset Registration form in the section labeled modes of operations. ERCOT will not unreasonably withhold acceptance of defining the Combined Cycle Facility with different modes of operations per the information provided in the Generation Resource Asset Registration and provided by trend analysis of historical forced outage data.

ERCOT will post the contingency unit list on MIS.

3. Voltage stability margin shall be sufficient to maintain post-transient voltage stability within a defined importing (Load) area under the following study conditions:
  - Peak Load conditions, with import to the area increased by five percent (5%) of the forecasted area Load, and NERC Category A or B operating conditions (see NERC Table I in ERCOT Planning Criteria); and
  - Peak Load conditions, with import to the area increased by two and one half percent (2.5%) of the forecasted area Load, and NERC Category C operating conditions.

The ERCOT SPF is responsible for gathering Load data, for use in the ERCOT Load flow cases via the ALDR. The ERCOT ROS coordinates with the ERCOT SPF in the performance of steady state and dynamic simulation testing of the bulk power system to determine the impact on the planned system of occurrences of the types of contingencies listed in the NERC Planning Standards. The Steady State Working Group (SSWG), Dynamics Working Group (DWG) and System Protection Working Group (SPWG) work with the ERCOT SPF to create databases and perform tests as outlined in these criteria.

These databases created by the ERCOT ROS Working Groups are available for use by ERCOT Market Participants. It is the responsibility of the individual ERCOT TDSPs to use these databases

to perform steady state and dynamic tests appropriate to evaluate the compliance of their Transmission Facilities with the ERCOT Planning Criteria and to recommend, for further study by ERCOT, tests, which examine effects of importance to multiple ERCOT TDSPs or the ERCOT bulk power system. Such tests are discussed by the ERCOT ROS and the ERCOT SPF and are subsequently performed under the direction of the ERCOT SPF or the ERCOT ROS as appropriate. The individual TDSPs affected by identified issues will pursue appropriate solutions.

### 5.1.5 Reports Of Testing

The ERCOT SPF annually directs the preparation of the section of the EIA-411 Report requested by the Department of Energy which addresses the adequacy of the ERCOT bulk power system as well as input to various NERC reports. Studies performed by ERCOT and comments by the individual TDSPs regarding tests that they have performed provide the basis for statements concerning the adequacy of the planned ERCOT System.

### 5.1.6 System Modeling Information

Information on existing and future ERCOT System components and topology is necessary for ERCOT to create databases and perform tests as outlined in these criteria. To ensure that such information is made available to ERCOT, the following actions by ERCOT Market Participants are required:

1. Each TDSP, or its designated agent, shall provide accurate modeling information for all ERCOT Transmission Facilities owned or planned by the TDSP. The information provided shall include, but not be limited to, the following:
  - a. Information necessary to represent the TDSP's Transmission Facilities in any model of the ERCOT Transmission Grid whose creation has been approved by ERCOT, including modeling information detailed in procedures of the SSWG, DWG, and SPWG;
  - b. Identification of a designated contact person responsible for providing answers to questions ERCOT may have regarding the information provided; and
  - c. TDSP owned or operated Transmission Facility data provided and used to accurately represent a Transmission Facility in a model shall be consistent to the extent practicable with data provided and used to represent that same Transmission Facility in any other model created to represent a time period during which the Transmission Facility is expected to be physically identical. All existing transmission line's and transformer's impedances (or equivalent branch circuit impedance) and ratings (Normal and Emergency) shall be identical, to the extent practicable. If all normally closed breakers and switches are closed and normally open breakers and switches are open in the Network Operations Model, the calculated line flows between substations in the Annual Planning Model shall be consistent (very close), when all models use the same Load magnitude and distribution, generation commitment and Dispatch, and Voltage Profile. The TDSP shall provide an explanation to ERCOT for data inconsistencies. Any long-term changes to the reactive capability must be provided by the facility owner to ERCOT, as-planned at least thirty (30) days prior to implementation and as-built no later than thirty (30) days after implementation, as changes or upgrades are made during the life of the Reactive Power facilities.

Further, each TDSP owning or planning Transmission Facilities shall attend the scheduled meetings and otherwise participate in the activities of the SSWG and the SPWG, unless specifically exempted from these activities by ERCOT.

2. Each Generation Resource (GR), or its designated agent, shall provide accurate modeling information for each existing or publicly-announced ERCOT generating unit for which it is the majority owner. The information provided shall include, but not be limited to, the following:
  - a. Information necessary to represent the GR's generation and interconnection facilities in any model of the ERCOT electrical system whose creation has been approved by ERCOT, including modeling information detailed in procedures of the SSWG, DWG, and SPWG; and
  - b. Identification of a designated contact person responsible for providing answers to questions ERCOT may have regarding the information provided.

Typical or representative information may be provided for planned facility additions or modifications, but such information shall be revised using actual design or construction information no later than thirty (30) days after it becomes available.

**Table I. Transmission Systems Standards — Normal and Contingency Conditions**

Category	Contingencies		System Limits or Impacts				
	Initiating Event(s) and Contingency Component(s)	Components Out of Service	Thermal Limits	Voltage Limits	System Stable	Loss of Demand or Curtailed Firm Transfers	Cascading <sup>c</sup> Outages
A – No Contingencies	All Facilities in Service	None	Normal	Normal	Yes	No	No
B – Event resulting in the loss of a single component.	Single Line Ground (SLG) or 3-Phase (3Ø) Fault, with Normal Clearing: 1. Generator 2. Transmission Circuit 3. Transformer Loss of a Component without a Fault.	Single Single Single Single	Applicable Rating <sup>a</sup> (A/R) A/R A/R A/R	Applicable Rating <sup>a</sup> (A/R) A/R A/R A/R	Yes Yes Yes Yes	No <sup>b</sup> No <sup>b</sup> No <sup>b</sup> No <sup>b</sup>	No No No No
	Single Pole Block, Normal Clearing: 4. Single Pole (dc) Line	Single	A/R	A/R	Yes	No <sup>b</sup>	No
C – Event(s) resulting in the loss of two or more (multiple) components.	SLG Fault, with Normal Clearing: 1. Bus Section 2. Breaker (failure or internal fault)	Multiple Multiple	A/R A/R	A/R A/R	Yes Yes	Planned <sup>d</sup> Planned <sup>d</sup>	No No
	SLG or 3Ø Fault, with Normal Clearing, Manual System Adjustments, followed by another SLG or 3Ø Fault, with Normal Clearing: 3. Category B (B1, B2, B3, or B4) contingency, manual system adjustments, followed by another Category B (B1, B2, B3, or B4) contingency	Multiple	A/R	A/R	Yes	Planned <sup>d</sup>	No

Category	Contingencies	Components Out of Service	System Limits or Impacts				
			Thermal Limits	Voltage Limits	System Stable	Loss of Demand or Curtailed Firm Transfers	Cascading <sup>c</sup> Outages
	Bipolar Block, with Normal Clearing: 4. Bipolar (dc) Line Fault (non 3Ø), with Normal Clearing: 5. Double Circuit Towerline	Multiple Multiple	A/R A/R	A/R A/R	Yes Yes	Planned <sup>d</sup> Planned <sup>d</sup>	No No
	SLG Fault, with Delayed Clearing: 6. Generator 8. Transformer 7. Transmission Circuit 9. Bus Section	Multiple Multiple	A/R A/R	A/R A/R	Yes Yes	Planned <sup>d</sup> Planned <sup>d</sup>	No No
D <sup>e</sup> – Extreme event resulting in two or more (multiple) components removed or cascading out	3Ø Fault, with Delayed Clearing (stuck breaker or protection system failure): 1. Generator 3. Transformer 2. Transmission Circuit 4. Bus Section 3Ø Fault, with Normal Clearing: 5. Breaker (failure or internal fault) Other: 6. Loss of towerline with three or more circuits	Evaluate for risks and consequences. May involve substantial loss of customer demand and generation in a widespread area or areas. Portions or all of the interconnected systems may or may not achieve a new, stable operating point. Evaluation of these events may require joint studies with neighboring systems. Document measures or procedures to mitigate the extent and effects of such					

Category	Contingencies	System Limits or Impacts					
	Initiating Event(s) and Contingency Component(s)	Components Out of Service	Thermal Limits	Voltage Limits	System Stable	Loss of Demand or Curtailed Firm Transfers	Cascading <sup>c</sup> Outages
of service	<p>7. All transmission lines on a common right-of way</p> <p>8. Loss of a substation (one voltage level plus transformers)</p> <p>9. Loss of a switching station (one voltage level plus transformers)</p> <p>10. Loss of a all generating units at a station</p> <p>11. Loss of a large load or major load center</p> <p>12. Failure of a fully redundant special protection system (or remedial action scheme) to operate when required</p> <p>13. Operation, partial operation, or misoperation of a fully redundant special protection system (or remedial action scheme) for an event or condition for which it was not intended to operate</p> <p>14. Impact of severe power swings or oscillations from disturbances in another Regional Council.</p>	<p>events.</p> <p>Mitigation or elimination of the risks and consequences of these events shall be at the discretion of the entities responsible for the reliability of the interconnected transmission systems.</p>					

#### Footnotes to Table I.

- a) Applicable rating (A/R) refers to the applicable normal and emergency facility thermal rating or system voltage limit as determined and consistently applied by the system or facility owner.
- b) Planned or controlled interruption of generators or electric supply to radial customers or some local network customers, connected to or supplied by the faulted component or by the affected area, may occur in certain areas without impacting the overall security of the

interconnected transmission systems. To prepare for the next contingency, system adjustments are permitted, including curtailments of contracted firm (non-recallable reserved) electric power transfers.

- c) Cascading is the uncontrolled successive loss of system elements triggered by an incident at any location. Cascading results in widespread service interruption, which cannot be restrained, from sequentially spreading beyond an area predetermined by appropriate studies.
- d) Depending on system design and expected system impacts, the controlled interruption of electric supply to customers (load shedding), the planned removal from service of certain generators, or the curtailment of contracted firm (non-recallable reserved) electric power transfers may be necessary to maintain the overall security of the interconnected transmission systems.
- e) A number of extreme contingencies that are listed under Category D and judged to be critical by the transmission planning entity(ies) will be selected for evaluation. It is not expected that all possible facility outages under each listed contingency of Category D will be evaluated.

## 5.1.7 ERCOT Clarifications and Definitions of NERC Planning Standards Contingency Types C and D

### 5.1.7.1 Category C

#### *Initiating Event and Contingency Component Definitions:*

"Bus Section" shall be interpreted to mean any section of buswork, which would be isolated by normal relay/breaker operation when faulted.

"Manual System Adjustments" shall be interpreted to include only operator actions which a) would be made not later than 1 hour after clearing of the first fault, b) are made using remote control capability or communications with other operators having such capability, c) include circuit switching, changes in the schedules of generating units operating at clearing of the first fault, and changes in the schedules of other generating units which can contribute within 1 hour, and d) exclude the physical repair or replacement of damaged equipment and the starting of any generating unit which cannot contribute within 1 hour.

#### *Planned Loss of Demand or Curtailed Firm Transfer Definition:*

All load interruption, generator tripping, or generation schedule changes must be either automatic or prearranged (with associated written operating procedures). Actions must be executable in time to avoid any equipment damage or safety violations, but in any case within 30 minutes of fault clearing.

#### *Cascading Outage Definition:*

Cascading outages are defined as the uncontrolled loss of any system facilities or load, whether because of thermal overload, voltage collapse, or loss of synchronism, except those occurring as a result of fault isolation.

#### *Implementation Guidelines:*

Equipment ratings and permissible voltage levels shall be determined by the facility owner with the concurrence of the ERCOT SPF.

Evaluation of all the possible combination of facility outages under Category C is not required. Each TDSP with bulk transmission facilities will evaluate one or more Category C contingencies annually. The contingencies selected may be based on the results of related studies or actual events and which, in the engineering judgment of the facility owner, the ERCOT SPF or any TDSP, may have unacceptable consequences.

### 5.1.7.2 Category D:

#### *Large Load or Major Load Center Definition:*

A large load or major load center shall be defined as a large single load or a group of electrically close loads comprising a peak load of between 50 and 500 MW. Loss of this load or load center will not include any other system elements other than those directly connected to the lost load.



***Evaluation Implementation:***

Evaluations of Category D contingencies are not required to be performed annually. Evaluations should be performed for the following:

1. Contingencies previously studied for which the conditions assumed in the study have changed significantly and which may adversely affect the results of the study.
2. Contingencies not previously studied that, based on the results of related studies or actual events may in the engineering judgment of the facility owner, the ERCOT SPF or any TDSP, have unacceptable consequences.

## 5.2 Document Control

### *Change History*

<b>ISSUE/DATE</b>	<b>REASON FOR ISSUE</b>
May 1, 2003	Moved "Planning Criteria" from Section 7 into this new Section 5.
June 1, 2004	OGRR 145; renumbered 5.3 Document Control to 5.2.
July 1, 2004	OGRR 148
April 1, 2006	OGRR 174
July 1, 2007	Admin OGRR201

---

---

# *ERCOT OPERATING GUIDES*

---

---

## Section 6: Reports and Forms

---

---

May 1, 2008

# Contents

<b>6</b>	<b>REPORTS AND FORMS .....</b>	<b>6-3</b>
6.1	REPORTS .....	6-3
6.1.1	<i>Disturbance Report .....</i>	<i>6-3</i>
6.1.2	<i>Relay Misoperation Report .....</i>	<i>6-4</i>
6.2	FORMS.....	6-5
6.2.1	<i>Turbine Governor Speed Regulation Tests .....</i>	<i>6-5</i>
6.2.2	<i>Seasonal Unit Net Real Power Capability Verification .....</i>	<i>6-18</i>
6.2.3	<i>Biennial Unit Reactive Limits (Lead and Lag) Verification.....</i>	<i>6-20</i>
6.2.4	<i>Seasonal Hydro Responsive Reserve Net Capability Verification .....</i>	<i>6-24</i>
6.2.5	<i>Annual LaaR Telemetry Test .....</i>	<i>6-25</i>
6.2.6	<i>Biennial Test for LaaRs Providing Responsive Reserve Service .....</i>	<i>6-26</i>
6.3	DOCUMENT CONTROL .....	6-31

## **6 Reports and Forms**

### **6.1 Reports**

#### **6.1.1 Disturbance Report**

##### **6.1.1.1 ERCOT Data**

ERCOT will record the following data when frequency deviations of 0.175 Hz or greater occur and will use this information to generate the ERCOT initial Disturbance Report:

- Net interchange (MW) immediately before the disturbance.
- Net interchange (MW) immediately after the disturbance.
- Control Bias.
- Net MW Capability (including any capability lost) at the time of the disturbance.
- Net System Load (MW) for the hour ending closest to the time of the disturbance.
- Scheduled Net Interchange (MW) at the time of the disturbance.
- Amount of interruptible load (MW) tripped.

##### **6.1.1.2 PGC Data**

The PGC losing the unit will provide the following data to the ERCOT Operator as soon as possible after the disturbance:

- Unit Lost.
- Released net dependable capability (MW).
- Net generation at time of loss.
- Nature of trouble/Reason for loss.
- Time/Date of loss.

The above information, plus unit performance data, will be used by ERCOT to generate detailed reports for the PDC Task Force and will be submitted to the PDC Task Force at the next regularly scheduled meeting.

**6.1.2 Relay Misoperation Report**

DATE:	TIME:	UTILITY:	VOLTAGE:
RELAY TYPE: STYLE #:	CB NUMBER:	LINE/BUS/AUTO/UNIT NAME:	
FLAGS:	MANUFACTURER:		

Description of Misoperation/Failure:

(80 Character)

Investigation Results:

(80 Character)

Corrective Action:

(80 Character)

Target Date:

--	--

Recommendations:

Reported By:			Date:
Phone Number:			

## 6.2 Forms

### 6.2.1 Turbine Governor Speed Regulation Tests

#### 6.2.1.1 Turbine Governor Speed Regulation Test for Mechanical-Hydraulic Governor

##### *GENERAL INFORMATION*

Unit Code (16 character): \_\_\_\_\_ Location (County) : \_\_\_\_\_

Unit Name: \_\_\_\_\_ Date of test: \_\_\_\_\_

QSE: \_\_\_\_\_ Resource Entity: \_\_\_\_\_

##### *Steady State Speed Regulation at High-Speed Stop*

$$R_s = \frac{(A - B) \times 100}{3600}$$

Where:

A = Speed with speed changer set at high-speed stop and with throttle (or stop) valves open and machine running idle on the governor.

B = Speed with speed changer set at high-speed stop and when governing valves just reach wide-open position.

##### *Steady State Speed Regulation at Synchronous Speed <sup>1</sup>*

$$R_s = \frac{(C - D) \times 100}{3600}$$

Where:

C = Speed with speed changer set for synchronous speed and with throttle (or stop) valves open and machine running idle on the governor.

D = Speed with speed changer set at the same position as in C above and when governing valves just reach wide open position.

##### *Steady State Speed Regulation at Low-Speed Stop*

$$R_s = \frac{(E - F) \times 100}{3600}$$

Where:

---

<sup>1</sup> Westinghouse recommends using only this test.

E = Speed with speed changer set at low-speed stop and with throttle (or stop) valves open and machine running idle on the governor.

F = Speed with speed changer set at low-speed stop and when governing valves just reach wide-open position.



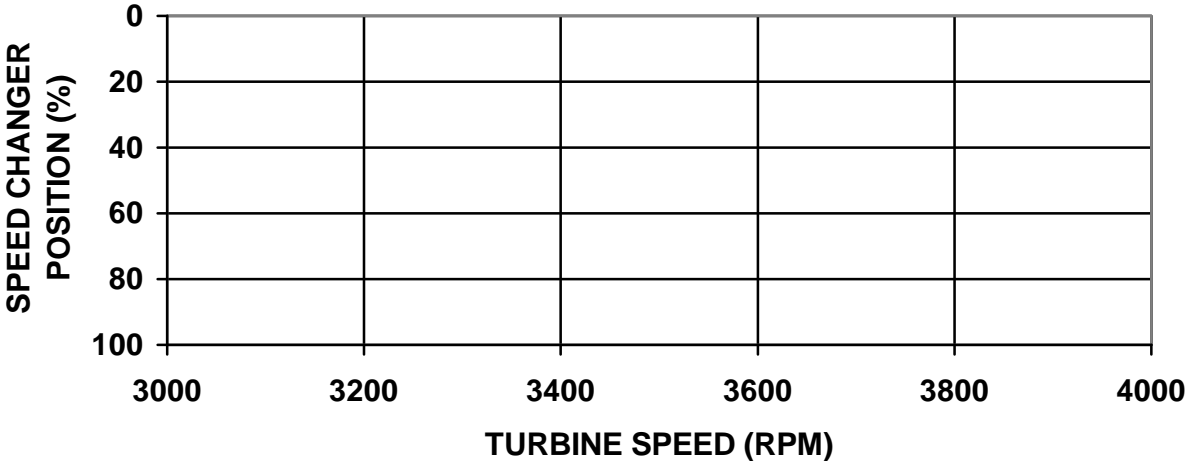

E, F @ Low Speed Stop  
 C, D @ Sync. Speed  
 A, B @ High Speed Stop

Point	Test Data					
	A	B	C	D	E	F
Speed, RPM						
Frequency Hz						

**Speed Changer Travel Time:**

- a. From Low-Speed Stop to High-Speed Stop in \_\_\_\_\_ seconds.
- b. From High-Speed Stop to Low-Speed Stop in \_\_\_\_\_ seconds.

Over-speed Trip Test Speed at \_\_\_\_\_ rpm.

Comments: \_\_\_\_\_  
 \_\_\_\_\_  
 \_\_\_\_\_  
 \_\_\_\_\_

**SUBMITTAL**

Resource Entity Representative: \_\_\_\_\_

QSE Representative: \_\_\_\_\_

Date submitted to ERCOT Control Area Authority Rep.: \_\_\_\_\_

### 6.2.1.2 Example of a Turbine Governor Speed Regulation Test for Mechanical-Hydraulic Governor

#### *Steady State Speed Regulation at High-Speed Stop*

$$R_s = \frac{(A - B) \times 100}{3600} = \frac{(3850 - 3570) \times 100}{3600} = 7.78\%$$

Where:

- A = Speed with speed changer set at high-speed stop and with throttle (or stop) valves open and machine running idle on the governor.  
 B = Speed with speed changer set at high-speed stop and when governing valves just reach wide-open position.

#### *Steady State Speed Regulation at Synchronous Speed<sup>2</sup>*

$$R_s = \frac{(C - D) \times 100}{3600} = \frac{(3600 - 3310) \times 100}{3600} = 8.06\%$$

Where:

- C = Speed with speed changer set for synchronous speed and with throttle (or stop) valves open and machine running idle on the governor.  
 D = Speed with speed changer set at the same position as in C above and when governing valves just reach wide open position.

#### *Steady State Speed Regulation at Low-Speed Stop*

$$R_s = \frac{(E - F) \times 100}{3600} = \frac{(3500 - 3210) \times 100}{3600} = 8.06\%$$

Where:

- E = Speed with speed changer set at low-speed stop and with throttle (or stop) valves open and machine running idle on the governor.  
 F = Speed with speed changer set at low-speed stop and when governing valves just reach wide-open position.

<sup>2</sup> Westinghouse recommends using only this test.

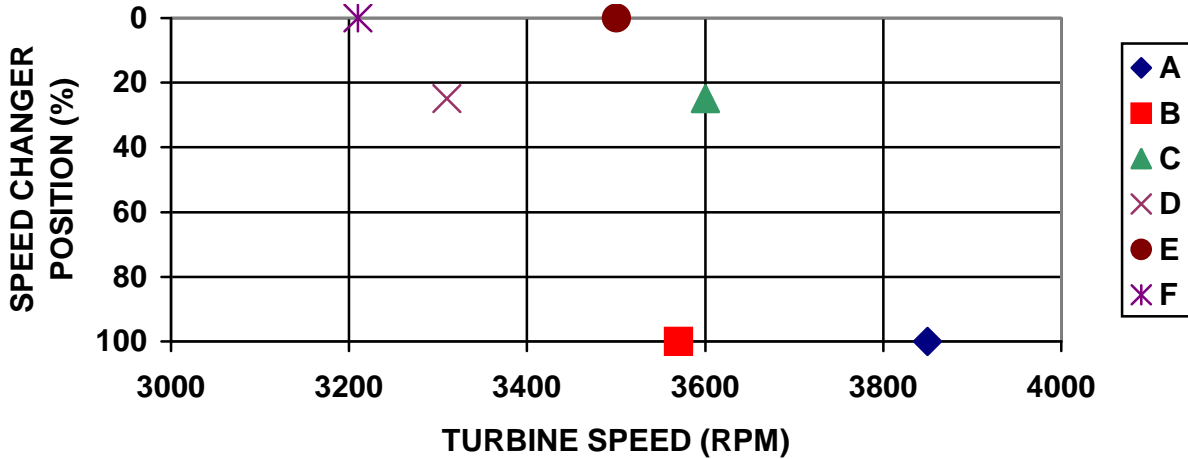

E, F @ Low Speed Stop  
 C, D @ Sync. Speed  
 A, B @ High Speed Stop

Point	Test Data					
	A	B	C	D	E	F
Speed, RPM	3850	3570	3600	3310	3500	3210
Frequency Hz	64.2	59.5	60.0	55.0	58.3	53.5

**Speed Changer Travel Time:**

- a. From Low-Speed Stop to High-Speed Stop in 73 seconds.
- b. From High-Speed Stop to Low-Speed Stop in 74 seconds.

Over-speed Trip Test Speed at 3965 rpm.

Comments: \_\_\_\_\_  
 \_\_\_\_\_  
 \_\_\_\_\_  
 \_\_\_\_\_  
 \_\_\_\_\_

### 6.2.1.3 Turbine Governor Speed Regulation Test for Electro-Hydraulic Governor

#### GENERAL INFORMATION

Unit Code (16 character): \_\_\_\_\_ Location (County) : \_\_\_\_\_

Unit Name: \_\_\_\_\_ Date of test: \_\_\_\_\_

QSE: \_\_\_\_\_ Resource Entity: \_\_\_\_\_

#### Turbine Governor Speed Regulation Test Procedures

- a. Simulate unit on line and turbine speed at 3600 RPM.
- b. Set load reference at minimum value.
- c. Monitor valve demand signal and record as value 'A' (in %).
- d. Reduce speed until valve demand just reaches maximum value.  
Record valve demand as value 'B' (in %) and speed as value 'C' (in RPM).
- e. Set speed at 3600 and load reference at maximum value.
- f. Monitor valve demand signal and record as value 'D' (in %).
- g. Increase speed until valve demand just reaches minimum value.  
Record valve demand as value 'E' (in %) and speed as value 'F' (in RPM).

#### Turbine Governor Speed Regulation Test Results

	<b>A</b>	<b>B</b>	<b>C</b>	<b>D</b>	<b>E</b>	<b>F</b>
<b>VALVE DEMAND (%)</b>						
<b>Speed (rpm)</b>						

#### Speed Regulation With Decreasing Speed

$$R_D = \frac{100}{(B - A)} \times \frac{(3600 - C)}{3600} \times 100$$

#### Speed Regulation With Increasing Speed

$$R_I = \frac{100}{(D - E)} \times \frac{(F - 3600)}{3600} \times 100$$

Comments: \_\_\_\_\_  
\_\_\_\_\_  
\_\_\_\_\_  
\_\_\_\_\_  
\_\_\_\_\_

***SUBMITTAL***

Resource Entity Representative: \_\_\_\_\_

QSE Representative: \_\_\_\_\_

Date submitted to ERCOT Control Area Authority Rep.: \_\_\_\_\_

### 6.2.1.4 Definitions

<b>System Frequency Response</b>	This response is a function of three key variables; the system's composite governor droop, the percent of spinning capacity which is actually providing governor response, and the frequency response characteristic of the connected load.
<b>Percent Droop Settings</b>	Also known as Frequency Regulation, Speed Regulation, Speed Sensitivity, Speed Error and others. Percent droop is the percent change in nominal frequency that will cause generator output to change from no load to full load. It is the change in steady state rotor speed, expressed in percent of rated speed, when power output is gradually reduced from rated to zero power. A common percent droop setting is 5% for both high and low frequency excursions.
<b>Dead Band</b>	The range of deviations of system frequency (+/-) that produces no turbine governor response, and therefore, no frequency (speed) regulation. It is expressed in percent of rated speed, Hz, or RPM.
<b>Valve Position Limiter</b>	A device that acts on the speed and load governing system to prevent the governor-controlled valves from opening beyond a pre-set limit.
<b>Blocked Governor Operation</b>	Operating the generating unit with the control system adjusted to prevent the turbine governor from responding to system frequency (speed) variations. In an effort to reduce speed governor operation in some generating units, turbine control systems can be adjusted to block the operation of the governor after the unit is in parallel with the system and is running at its desired output. Selection of a high percent droop characteristic or a large dead band constitutes a form of blocked governor action.
<b>Variable Pressure Operation</b>	Varying the boiler pressure to improve turbine efficiency at lower loads. Two methods are normally used. With one method, the turbine governor (G.E.) or control (Westinghouse) valves are positioned in the wide-open position and the generator is changed by changing the boiler pressure. With this method, there is very little, if any response to frequency excursions. With the other method, the valves are positioned at approximately 50% open. The valves are still able to respond to system disturbances. Normal changes in generation requirements are made by varying the boiler pressure until the unit is at rated pressure. After full pressure is reached, the turbine valves are used to make the required generation changes.

### 6.2.1.5 Combustion Turbine Frequency Response Test Procedure

#### *DESCRIPTION OF THE TEST*

1. The frequency response function of the combustion turbine is tested On-line at a Load level that allows combustion turbine to increase or decrease Load without reaching Low or High Operating Limits. The recommended level is 92% Base Load or below.
2. The test is performed by adding a frequency offset signal that exceeds the governor dead band value to the measured frequency signal. This should create immediate step change in the measured frequency signal.

3. The test starts at time  $t_0$  when the frequency dead-band is exceeded and signal "Combustion Turbine Frequency Response On" becomes active.
4. The following signals should be recorded at least every two (2) seconds: Unit MW Output, "Combustion Turbine Frequency Response On".
5. The duration of the test is one-hundred (100) seconds. After one-hundred (100) seconds, the offset signal should be removed and combustion turbine should return to pretest power output.
6. The test should be conducted both with positive and negative frequency offsets.
7. The test is considered successful after the signal "Combustion Turbine Frequency Response On" becomes active and maintained for thirty (30) seconds if 70% of the calculated MW contribution is delivered within sixteen (16) seconds.
8. Droop shall be set not to exceed 5% with a maximum frequency dead-band of +/- 0.036Hz.

### **DEFINITIONS**

**Combustion Turbine Base Load** = maximum load capability for the season when frequency response test is performed

$$\text{Gain MW for 0.1Hz} = \frac{P * 10}{\text{Droop} * 60}$$

, where  $P$  = Combustion Turbine Base Load (MW)  
 $\text{Droop}$  = droop (%)

**Frequency Offset** = +0.2Hz and -0.2Hz (+12 rpm and -12 rpm, for 3600 sync speed machines)

**Test frequency** = Measured Frequency + Frequency Offset

**MW Contribution** = Gain MW to 0.1Hz \* 10\*Frequency Offset

$$\text{Calculated droop} = - \frac{P * \Delta\text{Hz}}{60 * \Delta\text{MW}}$$

, where  $P$  = Combustion Turbine Base Load (MW)  
 $\Delta\text{Hz}$  = Change in frequency (Hz)  
 $\Delta\text{MW}$  = Change in power output (MW)

### **EXAMPLE**

Combustion Turbine Base Load = 150MW

Droop = 5%

$$\text{Gain MW to 0.1Hz} = \frac{150 * 10}{5 * 60} = +/- 5 \text{ MW}/0.1\text{Hz}$$

$$\text{MW Contribution} = 5 * 10 * +/- 0.2 = +/- 10\text{MW}$$

Expected under-frequency response: +10MW in 15 sec. for -0.2Hz offset

Expected over-frequency response: -10MW in 15 sec. for +0.2Hz offset

Minimum accepted under-frequency response: +7MW in 15 sec. for -0.2Hz offset

Minimum accepted over-frequency response: -7MW in 15 sec. for +0.2Hz offset

Calculated droop for 8MW increase in power output in 15 sec. for -0.2Hz offset:

$$\text{Calculated droop} = -\frac{150 * -0.2}{60 * 8} = 0.0625 \text{ or } 6.25\%$$

### ***COMBUSTION TURBINE FREQUENCY RESPONSE TEST FORM***

#### ***GENERAL INFORMATION***

Unit Code (16 characters): \_\_\_\_\_ Location (County): \_\_\_\_\_

Unit Name: \_\_\_\_\_ Date of Test: \_\_\_\_\_

QSE: \_\_\_\_\_ Resource Entity: \_\_\_\_\_

#### ***TEST RESULTS***

		Test with +0.2 Hz	Test with -0.2 Hz
1	CT Base load		
2	GAIN MW to 0.1Hz		
3	Calculated MW Contribution		
4	MW at test start (t <sub>0</sub> )		
5	MW at t <sub>0</sub> + 16 sec		
6	MW Contribution at t <sub>0</sub> + 16 sec		
7	MW at t <sub>0</sub> + 46 sec		
8	Calculated droop		
9	CONCLUSION (PASSED/FAILED)		

***Comments:***

---



***SUBMITTAL***

Resource Entity Representative: \_\_\_\_\_

QSE Representative: \_\_\_\_\_

Date submitted to ERCOT Control Area Authority Rep.: \_\_\_\_\_

**6.2.1.6 Combustion Turbine Frequency Response Procedures Based on Historical Data*****DESCRIPTION OF HISTORICAL VERIFICATION***

The purpose of this template is to allow the QSE to demonstrate acceptable frequency response of their combustion turbines based on historical data in order to minimize testing costs, scheduling conflicts and the risk of damage to equipment or Forced Outage.

1. All verifications will be based on at least one of the Performance, Disturbance, Compliance Working Group's (PDCWG) list of "Measurable Events" as defined in the ERCOT Protocols. Different turbines can be tested using different events.
2. For clarification purposes, the A, B, B+30 and C points are defined in Protocol Section 5.9.2, Primary Frequency Control Measurements. Point A will be considered the start of the verification process. The exact time of each Point is identified in the PDCWG Disturbance Report on the event.
3. The following signals should be recorded at EMS scan rate: Unit MW Output and ERCOT Actual Frequency from the PDCWG Disturbance Report on the event.
4. The verification is considered successful if 70% of the calculated MW contribution is delivered within 16 seconds after the C point and maintained for 30 seconds.
5. Droop should be set not to exceed 5% and a maximum frequency deadband of +/- 0.036Hz.
6. ERCOT Operations will supply frequency data and time of each evaluation point (A, C, B & B+30) for the event data chosen for the test.

***DEFINITIONS***

Combustion Turbine Base Load = maximum load capability for the season when frequency response test is performed

$$\text{Gain MW for 0.1Hz} = \frac{P * 10}{\text{Droop} * 60}$$

, where  $P$  = Combustion Turbine Base Load (MW)  
 $\text{Droop}$  = droop (%)

$$\text{Calculated droop} = - \frac{P * \Delta Hz_{C,B,B+30}}{60 * \Delta MW_{C,B,B+30}}$$

, where  $P$  = Combustion Turbine Base Load (MW)  
 $\Delta Hz$  = Change in frequency (Hz) between Point A and Point C, B or B+30  
 $\Delta MW$  = Change in power output (MW) between Point A and Point C, B or B+30

$$\text{Adjusted droop} = - \frac{P * \Delta Hz_{C,B,B+30}}{60 * (\Delta MW_{C,B,B+30} + OC_{C,B,B+30})}$$

, where  $OC$  = Obligation Change

**Obligation Change** =  $\Delta$  MW Schedule from Point A to Point B + 30 if negative in an under-frequency event or if positive in an over-frequency event, else 0.

**EXAMPLE**

CT Base Load = 150MW

Droop = 5%

$$\text{Gain MW to 0.1Hz} = \frac{150 * 10}{5 * 60} = +/-5 \text{ MW}/0.1\text{Hz}$$

Expected under-frequency response: +5MW in 15 sec. for -0.1Hz offset

Expected over-frequency response: -5MW in 15 sec. for +0.1Hz offset

Minimum accepted under-frequency response: +3.5MW in 15 sec. for -0.1Hz offset

Minimum accepted over-frequency response: -3.5MW in 15 sec. for +0.1Hz offset

Calculated droop for 5 MW increase in power output in 15 sec. for -0.1Hz offset:

$$\text{Calculated droop} = - \frac{150 * -0.1}{60 * 5} = 0.05 \text{ or } 5.00\%$$

Schedule drop of 10 MW from point A to B + 30 with 10 frequency responsive units:

$$OC = 10/10 = 1 \text{ MW}$$

$$\text{Adjusted droop} = - \frac{150 * -0.1}{60 * (5 + 1)} = 0.0416 \text{ or } 4.16\%$$

**REFERENCE: PROTOCOL SECTION 5.9.2, PRIMARY FREQUENCY CONTROL MEASUREMENTS**

*For the purposes of this section, the A Point is the last stable frequency value prior to a frequency disturbance. For a decreasing frequency event with the last stable frequency value of 60.000 Hz or*

below, the actual frequency is used. For a decreasing frequency event with the last stable frequency value between 60.000 and 60.036 Hz, 60.000 Hz will be used. For a decreasing frequency event with the last stable frequency value above 60.036 Hz, actual frequency will be used. For an increasing frequency event with the last stable frequency value of 60.000 or above, the actual frequency is used. For an increasing frequency event with the last stable frequency between 59.964 and 60.000 Hz, 60.000 Hz will be used. For an increasing frequency event with the last stable frequency value of 59.964 or below, the actual frequency is used. ERCOT shall determine the A Point frequency for each event.

For the purposes of this section, the C Point is the lowest frequency value during the first five seconds of the event.

For the purposes of this section, the B Point is the “recovery” frequency value after the C Point. The B Point should occur after full governor response of the turbines has occurred, usually between ten (10) and thirty (30) seconds after the A Point, but not greater than sixty (60) seconds after the A Point. ERCOT shall determine the B Point for each event.

*B Point Plus Thirty Seconds:* At thirty seconds following the B Point, an analysis will be performed by ERCOT with the assistance of the appropriate ERCOT subcommittee to determine if primary frequency control response is sustained.

For the purposes of this section, a “Measurable Event” is the sudden change in interconnection frequency that will be evaluated for performance compliance will have i) a frequency B Point between 59.700 Hz and 59.900 Hz or between 60.100 Hz and 60.300 Hz, and ii) a difference between the B Point and the A Point greater than or equal to +/- 0.100 Hz.

### **HISTORICAL COMBUSTION TURBINE FREQUENCY RESPONSE TEST FORM**

#### **GENERAL INFORMATION**

Unit Code (16 character): \_\_\_\_\_ Location (County): \_\_\_\_\_

Unit Name: \_\_\_\_\_ Date of Event: \_\_\_\_\_

QSE: \_\_\_\_\_ Resource Entity: \_\_\_\_\_

#### **HISTORICAL RESULTS**

<b>EVALUATION POINT</b>	<b>TIME</b>	<b>FREQUENCY</b>
<b>POINT A</b>		
<b>POINT C</b>		
<b>POINT B</b>		
<b>POINT B+30</b>		

2	CT Base load	
3	MW at A Point	
4	MW at B Point	
5	MW at B + 30 Point	
6	MW at C Point	
7	Calculated Droop at B Point	
8 8A	Compensation for Obligation Change: Number of Freq. Resp. Units	
8B	Schedule $\Delta$ from Point A to Point B + 30	
8C	Schedule $\Delta$ for Observed Unit (8B/8A)	
9	Adjusted droop at B + 30	
10	(PASSED/FAILED) Pass if #7 & #9 < 7.14%, else Fail	

**Comments:**

---



---



---

**SUBMITTAL**

Resource Entity Representative: \_\_\_\_\_

QSE Representative: \_\_\_\_\_

Date submitted to ERCOT Control Area Authority Rep: \_\_\_\_\_

**6.2.2 Seasonal Unit Net Real Power Capability Verification****GENERAL INFORMATION**

Unit Code (16 character): \_\_\_\_\_ Location (County): \_\_\_\_\_

Unit Name: \_\_\_\_\_ Date of test: \_\_\_\_\_

Generator's QSE: \_\_\_\_\_ Resource Entity: \_\_\_\_\_

**TEST RESULTS**

Start Time: \_\_\_\_\_ Start MW: \_\_\_\_\_

MW 10 Minutes after Start Time: \_\_\_\_\_ Time to Reach Maximum Generation: \_\_\_\_\_

Temperature at Plant (°F): \_\_\_\_\_ MW at Maximum Generation: \_\_\_\_\_

MWH Net during the First Full Clock Hour after Maximum Generation is reached: \_\_\_\_\_

Limiting Factors: \_\_\_\_\_

---

***SUBMITTAL***

Resource Entity Representative: \_\_\_\_\_

QSE Representative: \_\_\_\_\_

Date submitted to ERCOT Control Area Authority Rep.: \_\_\_\_\_

**6.2.3 Biennial Unit Reactive Limits (Lead and Lag) Verification****GENERAL INFORMATION**

Unit Code : \* \_\_\_\_\_ Location (County): \* \_\_\_\_\_

Unit Name: \* \_\_\_\_\_ Date of test: \* \_\_\_\_\_

Generator's QSE: \* \_\_\_\_\_ Resource Entity: \* \_\_\_\_\_

**TEST DETAILS****Instructions:**

Maximum lagging reactive tests should be performed with the unit at or above 95% of the current dependable MW capability. Leading reactive tests may be performed during light Load conditions of the ERCOT System or at a normal operating real output (MW) that leading reactive capability can be measured and tested within the limits established by the Corrected Unit Reactive Limit (CURL) curve. This form is to be submitted by the QSE to ERCOT with a copy of the generator reactive capability design curve or the CURL curve as described in Section 3.1.4.3, Unit Reactive Capability Testing, marking the measured maximum output capability. This measured capability must be equal to or greater than 90% of the established CURL on the submitted generator reactive capability design curve or the CURL curve. Inability to reach the value described above must be noted with an explanation of the limiting factor, which prevented design capability or CURL capability performance. The inability to reach the measurement criteria may be cause for ERCOT 1) to require the Resource Entity to retest the generator's performance for a lagging test only or 2) to require the Resource Entity to produce a CURL curve that reflects current operating limits. The Resource Entity shall verify that the Automatic Voltage Regulator is in service. The minimum acceptable test duration is 15 minutes. During a Coordinated Test, as described in Section 3.1.4.3 of these Operating Guides, the normally specified switchyard voltage should be maintained by adjusting voltage control devices/units in so far as possible. Show leading reactive value as a negative (-) number.

\* This entry is required for all tests

**\*CORRECTED UNIT REACTIVE LIMIT (CURL) CURVE: (1)**

Maximum Lagging Reactive at current Gross Dependable MW Output \_\_\_\_\_ MVAR(Gross) at \_\_\_\_\_ MW(Gross) (1)

Maximum Lagging Reactive at current Gross Low Sustained Limit MW Output \_\_\_\_\_ MVAR(Gross) at \_\_\_\_\_ MW(Gross) (1)

Maximum Leading Reactive at current Gross Dependable MW Output \_\_\_\_\_ MVAR(Gross) at \_\_\_\_\_ MW (Gross) (1)

Maximum Leading Reactive at current Gross Low Sustained Limit MW Output \_\_\_\_\_ MVAR(Gross) at \_\_\_\_\_ MW(Gross) (1)

**\* Defined Test:** Coordinated Test Non-Coordinated Test**\*Test Performed:** Maximum Leading Reactive Maximum Lagging Reactive**\*Location at which data observed (specify all that apply):** Generator Terminals (preferred) High Voltage side of Generator Step-Up (GSU) Transformer Other (specify location): \_\_\_\_\_**TESTED REACTIVE CAPABILITY**



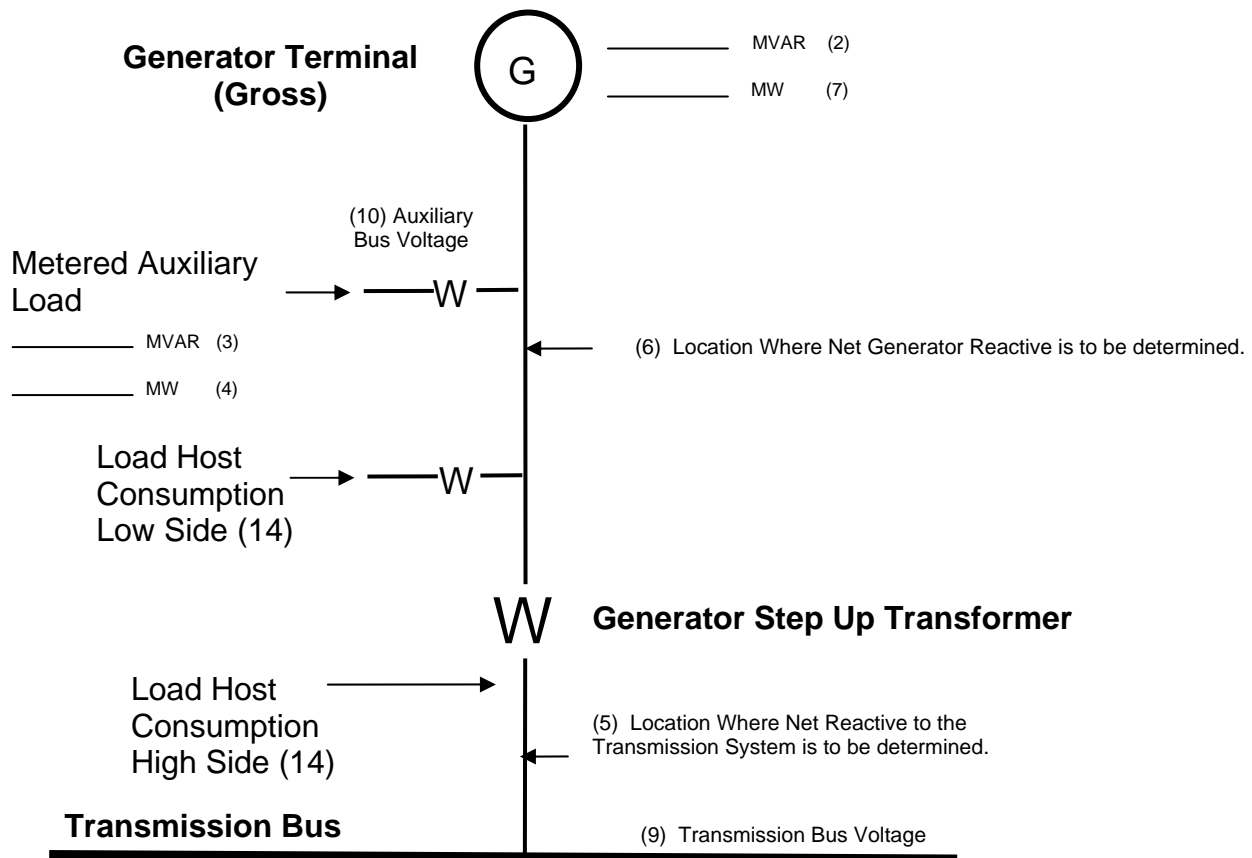

## NOTES

- (1) These quantities are taken directly from the Corrected Machine Capability Curve. The MVAR reactive maximum lagging value is the expected output at the generator terminal (gross output) with the generating unit at the Gross Dependable MW Output. This is the Gross equivalent of the Net Dependable Output. The MVAR reactive maximum leading value is the expected output at the generator terminal (gross output) with the generating unit at the Gross Low Sustained Limit MW output. This is the Gross equivalent of the Net Low Sustained Limit. The Maximum Lagging Reactive at current Gross Low Sustained Limit and Maximum Leading Reactive at current Gross Low Sustained Limit are used for curve validation only.
- (2) Metered reactive at the generator's terminals,
- (3) Auxiliary Reactive Load (Load only associated with Generator such as fans, boiler pumps etc.),
- (4) Metered Auxiliary Real Load (Load only associated with Generator),
- (5) **Observed** – metered reactive on the high side of the generator step up transformer to the transmission system,  
**Calculated** - (+/-) metered reactive at the generator's terminals minus metered Auxiliary Reactive consumption minus generator step up transformer reactive losses minus Load host reactive consumption (Load host does not apply to most generators but only pertains to generators with self serve load),
- (6) **Observed** - (+/-) as metered, Gross generator reactive minus metered Auxiliary Reactive consumption,  
**Calculated** - (+/-) metered net reactive to the transmission system minus generator step up



transformer reactive losses minus Load host reactive consumption (Load host does not apply to most generators but only pertains to generators with self serve load),

- (7) Metered at the generator terminals,
- (8) Most current tested value on record at ERCOT,
- (9) Required for Coordinated Test,
- (10) (if limiting),
- (11) PSIG can be determined from PSIA by subtracting 14.7 from the PSIA gauge reading
- (12) Actual tap setting – not nominal tap setting,
- (13) Describe fully.
- (14) Load Host consumption exists on either the low side or the high side of the step up transformer but typically not both.

**6.2.4 Seasonal Hydro Responsive Reserve Net Capability Verification**

***GENERAL INFORMATION***

Unit Code (16 character): \_\_\_\_\_ Location (County): \_\_\_\_\_  
Unit Name: \_\_\_\_\_ Date of test: \_\_\_\_\_  
Generator's QSE: \_\_\_\_\_ Resource Entity: \_\_\_\_\_

***TEST DETAILS***

Start Time \_\_\_\_\_  
Start MW \_\_\_\_\_ MW at 4 seconds \_\_\_\_\_ MW at 10 seconds \_\_\_\_\_  
Max MW \_\_\_\_\_

***SUBMITTAL***

Resource Entity Representative: \_\_\_\_\_  
QSE Representative: \_\_\_\_\_  
Date submitted to ERCOT Control Area Authority Rep.: \_\_\_\_\_

**6.2.5 Annual LaaR Telemetry Test****GENERAL INFORMATION**

Date: \_\_\_\_\_ Location (County): \_\_\_\_\_

ERCOT Asset Code: \_\_\_\_\_ LaaR's QSE: \_\_\_\_\_

Load Resource Name: \_\_\_\_\_ Load Point Name: \_\_\_\_\_  
(multiple points only)**INSTRUCTIONS**

As specified in Protocol Section 6.10.2, General Capacity Testing Requirements, a Load acting as a Resource that is providing Ancillary Services shall have its telemetry attributes verified by ERCOT annually. This annual verification is performed between the Load acting as a Resource and the QSE representing the Resource. The Telemetry Test Results should reflect the actual status of each of the telemetered points being submitted to ERCOT during a specified interval. If the LaaR consists of more than one Load point with multiple breakers and/or under frequency relays (the latter applicable to LaaRs providing Responsive Reserve Service), please submit one form per Load point. ERCOT will perform a comparison of the data provided on this form to the actual telemetered values received by ERCOT. Any significant variances will be reported back to the QSE to investigate and correct. ERCOT will send the QSE a copy of each validated test form.

**TELEMETRY TEST RESULTS**

Start Time Interval: \_\_\_\_\_

LaaR Breaker Status: \_\_\_\_\_ Response MW: \_\_\_\_\_

UFR Status\*: \_\_\_\_\_ MW at Maximum Load\*\*: \_\_\_\_\_

Note: \* Only applicable to LaaRs providing Responsive Reserve Service

\*\* Maximum available capacity for each LaaR will be capped to the Maximum Load test level

By signature below, the LaaR Representative certifies that the telemetry and high set under frequency relays, where applicable, are in place and fully functional.

**SUBMITTAL**

LaaR Representative Name: \_\_\_\_\_ Signature: \_\_\_\_\_

QSE Representative: \_\_\_\_\_ Date submitted to ERCOT: \_\_\_\_\_

**ERCOT Validation By:** \_\_\_\_\_ **Date:** \_\_\_\_\_

**6.2.6 Biennial Test for LaaRs Providing Responsive Reserve Service****GENERAL INFORMATION**

Date: \_\_\_\_\_ Location (County): \_\_\_\_\_

ERCOT Asset Code: \_\_\_\_\_ LaaR's QSE: \_\_\_\_\_

Load Resource Name: \_\_\_\_\_ Load Point Name: \_\_\_\_\_  
(multiple points only)**INSTRUCTIONS**

As specified in Protocol Section 6.10.2, General Capacity Testing Requirements, a Load acting as a Resource providing Responsive Reserve Service shall test each under frequency relay or solid state controller, whichever applies, for correct operation. A separate certified relay test results sheet is to be attached for each relay tested. Please provide sufficient notation on each test sheet to assist ERCOT in matching up the sheet to individual relays. This test of the under frequency relay does not require the Load to be interrupted. If, within the biennial testing period, the Load's performance has been verified through the correct response to an actual event, the data from that event can be supplied to meet this requirement and the required annual telemetry test. The date, interval, and other information associated with the event are to be noted below. ERCOT will return a copy of the validated test form to the QSE.

**VERIFICATION OF TELEMERGED RESPONSE TO AN ACTUAL EVENT**

Date of event: \_\_\_\_\_ Interval of event: \_\_\_\_\_

LaaR Breaker Status : \_\_\_\_\_ MW Load Prior to Event: \_\_\_\_\_

UFR Status: \_\_\_\_\_ Instantaneous Response MW: \_\_\_\_\_ Frequency deviation Hz: \_\_\_\_\_

Time Load restored: \_\_\_\_\_ ERCOT Operator: \_\_\_\_\_

**SUBMITTAL**

By signature below the LaaR representative certifies the high set under frequency relay(s) are in place and fully functional.

LaaR Representative Name: \_\_\_\_\_ Signature: \_\_\_\_\_

Name of Company Performing Relay Test: \_\_\_\_\_

QSE Representative: \_\_\_\_\_ Date submitted to ERCOT: \_\_\_\_\_

ERCOT Validation By: \_\_\_\_\_ Date: \_\_\_\_\_

**Note: Please attach certified relay test results sheet(s) to this form when submitting to ERCOT**







## 6.2.7 Unit Alternative Fuel Capability

### MARKET PARTICIPANT - PROTECTED INFORMATION

THIS INFORMATION IS PROTECTED INFORMATION PURSUANT TO SECTION 1.3.1.1(24) OF THE ERCOT PROTOCOLS AND CONTAINS CONFIDENTIAL/PROPRIETARY INFORMATION OF THE MARKET PARTICIPANT. THIS INFORMATION MUST BE KEPT STRICTLY CONFIDENTIAL AND IS PROVIDED TO ERCOT EMPLOYEES ONLY ON A "NEED TO KNOW" BASIS AND WILL NOT BE SHARED WITH ANYONE OUTSIDE ERCOT.

Natural Gas Fuel								
Column 1	Column 2	Column 3	Column 4	Column 5	Column 6	Col 7	Col 8	Column 9
Unit Code	Planned Average MWh/day (firm+ nonfirm gas)	Average MWh/day firm gas only	Maximum MW instantaneo us firm + non-firm gas	Maximum MW instantaneo us firm gas only	Date Range - (e.g. Nov. 07 - 14)	Delivery (Excluding Force Majeure)		Comments
						Firm%	Non Firm%	
Unit A	2	0	100	0	December 7-9	0%	100%	
Unit B	290	0	600	0	December 7-9		100%	
Unit C	0	0	0	0	December 7-9	0	0	Available but not planned on
Unit D	79	40	650	100	December 7-9	51%	49%	
Unit E					December 7-9			Forced off until December 15
Unit F	33	33	190	0	December 7-9	100%	0%	
Unit G	0	0	0	0	December 7-9			

Note: The form is filled out with examples to help clarify.

In column 2 enter the sum of MWh projected to run over the day, divided by 24

In column 3, enter the sum of MWh projected to run over the day supported by FIRM GAS only, divided by 24

In column 4, enter the maximum MW projected to run instantaneously

In column 5, enter the maximum MW projected to run instantaneously that can be supported by FIRM gas and firm delivery

In column 6, enter the date range this data covers. If it changes, provide multiple date range entries for each unique occurrence.

In column 7, enter the column 3 entry divided by the column 2 entry.

In column 8, enter the column 2 entry, minus the column 3 entry, divided by the column 2 entry (2-3)/2



### 6.3 Document Control

#### *Authorities*

<b>Prepared by:</b>	<b>Date Completed:</b>	<b>Reviewed by:</b>	<b>Date Authorized:</b>
E. Irwin, Technical Writer	12/29/2000	B. Garza, Chair Joint Operating Guides WG	December 29, 2000
I. Flores	4/17/2002	OGRTF/ROS	
I. Flores	8/15/2002	OGRTF/ROS	July 11, 2002
I. Flores	12/01/2002	OGRTF	October 24, 2002

#### *Distribution List*

<b>Name</b>	<b>Organization</b>
Operating Guide Revision Task Force (OGRTF)	Reliability Operations Subcommittee
Operations	ERCOT
Technical Advisory Committee	ERCOT
Reliability Operations Subcommittee	Technical Advisory Committee

#### *Change History*

<b>Issue/Draft</b>	<b>Reason for issue</b>	<b>Date</b>
Version 0.1	Draft for Review	December 29, 2000
Version 0.2	Not Issued	
Version 0.3	Include comments from seminar	January 19, 2001
Version 0.4	Include comments from second seminar	February 5, 2001
Version 1.0	Updated from Working Group comments. Submitted to Technical Advisory Committee to approve handover to the Reliability Operating Subcommittee	February 28, 2001
May 1, 2002	OGRR106	May 1, 2002
September 1, 2002	OGRR109; Subsection A.1.2.	September 1, 2002
December 1, 2002	Reformat section numbering from Appendix A to Section 6.	December 1, 2002
November 1, 2003	Deleted redundant signature lines from 6.2.3	November 1, 2003
May 1, 2004	OGRR146 deleted Section 6.1.3 and added Sections 6.2.6 and 6.2.7	May 1, 2004

<b>Issue/Draft</b>	<b>Reason for issue</b>	<b>Date</b>
December 1, 2004	OGRR153	December 1, 2004
February 1, 2005	OGRR157	February 1, 2005
June 1, 2006	OGRR169, OGRR178	June 1, 2006
May 1, 2008	Admin OGRR207	May 1, 2008

---

---

# *ERCOT OPERATING GUIDES*

---

---

## Section 7: Disturbance Monitoring and System Protection

---

---

October 1, 2007

**PUBLIC**

# Contents

<b>7</b>	<b>DISTURBANCE MONITORING AND SYSTEM PROTECTION.....</b>	<b>7-3</b>
7.1	DISTURBANCE MONITORING REQUIREMENTS .....	7-3
7.1.1	<i>Introduction.....</i>	7-3
7.1.2	<i>Fault Recording Equipment.....</i>	7-3
7.1.3	<i>Dynamic Disturbance Recording Equipment .....</i>	7-6
7.1.4	<i>Equipment Reporting Requirements .....</i>	7-6
7.1.5	<i>Review Process .....</i>	7-6
7.2	SYSTEM PROTECTIVE RELAYING .....	7-7
7.2.1	<i>Introduction.....</i>	7-7
7.2.2	<i>Design and Operating Requirements for ERCOT System Facilities .....</i>	7-7
7.2.3	<i>Performance Analysis Requirements for ERCOT System Facilities.....</i>	7-10
7.2.4	<i>Maintenance and Testing Requirements for ERCOT System Facilities .....</i>	7-12
7.2.5	<i>Requirements and Recommendations for ERCOT System Facilities.....</i>	7-12
7.3	DOCUMENT CONTROL.....	7-23

## 7 Disturbance Monitoring and System Protection

### 7.1 Disturbance Monitoring Requirements

#### 7.1.1 Introduction

Disturbance monitoring is necessary to determine:

- The performance of the ERCOT system,
- The effectiveness of protective relaying systems,
- Verify ERCOT system models, and
- Determine the causes of ERCOT system disturbances (unwanted trips, faults, and protective relay system actions).

To ensure that adequate data is available for these activities, the disturbance monitoring requirements and procedures discussed in this document have been established by ERCOT for Facility Owners in the ERCOT system.

Disturbance monitoring equipment includes digital fault recorders (DFRs), certain protective relays with fault recording capability, and dynamic disturbance recorders (DDRs). Sequence-of-event recorders (SERs), although considered equipment to monitor disturbances, are not preferred devices, as they provide limited information. SERs have been replaced by digital fault recorders and microprocessor-based protective relays.

#### 7.1.2 Fault Recording Equipment

Fault recording equipment includes digital fault recorders (DFRs) and protective relays with fault recording capability that meet the triggering requirements below. Fault recording equipment required by these Operating Guides shall be time synchronized with a Global Positioning System-based clock, or ERCOT-approved alternative, with sub-cycle (17 millisecond) timing accuracy and performance.

##### 7.1.2.1 Triggering Requirements

Fault recording equipment triggering must occur for system voltage magnitude and current magnitude disturbances (delta V and delta I) without requiring any circuit breaker operations or trip outputs from protective relay systems. Triggering by additional methods is acceptable. Triggering shall be adjusted to operate for faults in the area to be monitored, which should overlap into the area of coverage of adjacent fault recorders.

##### 7.1.2.2 Location Requirements

The location criteria below shall apply to equipment operated at or above 100 kV. The Facility Owner, whether registered as a TDSP or Resource Entity, shall install fault recording equipment at the following facilities, at a minimum:

- a. Interconnections to other Regions (i.e. outside ERCOT).

- b. Switching stations where electrical transfers of equipment can be made between ERCOT and another Region.
- c. Switching stations having three or more non-radial 345 kV line terminals. If a switching station is one bus removed from a station with a larger number of line terminals, then the fault recorder shall be located at the larger station and not required at the smaller station.
- d. Switching stations that are more than one circuit breaker-controlled bus away from a fault recorder and have five or more non-radial line terminals.
- e. For the purpose of evaluating #c. and #d. in this section, autotransformer or generating capacity totaling 150 MVA or greater (based upon minimum nameplate rating upon which transformer impedance is stated, i.e., base rating) shall constitute a non-radial line terminal at the highest voltage level to which it is directly connected.
- f. All generating station switchyards connected to the ERCOT System with an aggregated generating capacity above 100 MVA or the remote line terminals of each generating station switchyard.

All fault recording equipment shall be either DFR's or fault recording protective relays

#### 7.1.2.3 Data Recording Requirements

The following quantities must be recorded for equipment operating at 100 kV or above at facilities where fault recording equipment is required:

- a. Two sets of voltages for breaker-and-a-half and ring bus substation configurations. One set of voltages for each bus in other substation configurations. A set of voltages shall consist of each phase voltage waveform and the residual voltage waveform.
- b. For all lines, neutral (residual) current waveform.
- c. Circuit breaker status.
- d. Circuit breaker trip circuit status.
- e. Date and time stamp (CST).

For all new or upgraded fault recorder installations, additional items must also be recorded, as follows:

- f. For all autotransformers, current waveform for three phases and either neutral / residual current waveform or current waveform in delta windings.
- g. For all lines, two phase current waveforms.
- h. Status – carrier transmitter control, i.e. start, stop, keying.
- i. Status – carrier received.

#### 7.1.2.4 Data Retention and Reporting Requirements

The Facility Owner shall store all recorded fault data for at least a two year period. This data shall be stored in the form of a computer file or files.

Facility Owners shall provide fault recordings to ERCOT or NERC upon their request, within five Business Days, along with channel identification and scaling information to allow analysis

of the recordings. Fault recordings shall be shared between Facility Owners, upon their request, for the analysis of system disturbances.

Data submissions shall be COMTRADE fault recordings (.cfg and .dat files) and one or more identification files that associate the COMTRADE recordings with system disturbances and ERCOT short circuit database bus numbers. The identification file shall be a Microsoft Excel spreadsheet or comma delimited ASCII text that can be read into a Microsoft Excel spreadsheet. For this file, the data fields to be reported for each record, in the following order, are:

#### REPORTING ENTITY

<b>Faulted Circuit</b>	<b>Circuit or Bus (1, 2, A, B, N, S, etc.)</b>
	From Bus (ERCOT short circuit database bus number)
	To Bus (ERCOT short circuit database bus number)
	Nominal Voltage of Faulted Branch or Bus (kV)
	Physical Fault Location in Percent from "From Bus" (if physical location found, i.e. not calculated location)
	Date (CST, MM/DD/YYYY)
	Time (CST, HH:MM:SS, 24 hour format)
	Cause Code
<b>Fault Recorder Data</b>	<b>Circuit (1, 2, A, B, N, S, etc.)</b>
	From Bus – Recorder Location (ERCOT short circuit database bus number)
	To Bus – Monitored branch (ERCOT short circuit database bus number)
	Nominal Voltage of Monitored Branch (kV)
	Measured Current Magnitude (primary value in RMS amperes)
	Recorded Fault Duration (cycles)
	Fault Type (using reporting entity's phase designations – AB, CG, etc.)
<b>Optional Comments (40 char. max.)</b>	

When multiple recordings exist for a single event, data from the best recording (usually the closest recorder) is required.

ERCOT shall compile a summary list of all available 345 kV fault recordings annually based on each Facility Owner's submitted data. This summary shall contain for each recording the date, time, fault recorder owner, fault recorder location, the primary system element recorded, and an optional use comment field. This summary shall be available to any ERCOT Member upon their request. Record summaries will be retained by ERCOT for a minimum of three years.

#### **7.1.2.5 Maintenance and Testing Requirements**

Facility Owners shall maintain and test their Fault recording equipment as follows:

- In accordance with the manufacturer's recommendations.
- Calibration of the analog (waveform) channels shall be performed at installation and when records from the equipment indicate a calibration problem. Calibration can be monitored through the analysis and correlation of fault records with system models and the records of other fault recorders in the area.
- Fault recording equipment must be operationally tested at least annually to ensure that the equipment is functional. Acceptable tests are the production of a manually triggered record (remotely or at the device), or automatic record production due to a power system disturbance.

#### **7.1.3 Dynamic Disturbance Recording Equipment**

*RESERVED*

#### **7.1.4 Equipment Reporting Requirements**

Facility Owners shall maintain a current database summarizing their disturbance monitoring equipment installations.

The database shall include installation location, type of equipment, make and model of equipment, operational status, a listing of the major equipment being monitored and the date the equipment was last tested. This database shall be submitted to ERCOT annually, by October 31. Additionally, a complete list of all monitored points at each installation shall be maintained by Facility Owners and provided, when requested specifically by ERCOT or NERC, within 30 days.

ERCOT shall maintain a comprehensive database of all Facility Owner's disturbance monitor equipment submittals, updated annually.

#### **7.1.5 Review Process**

ERCOT shall review fault recorder and disturbance recorder locations for compliance and adequacy when significant changes are made to the ERCOT system or at least every five years.



## 7.2 System Protective Relaying

### 7.2.1 Introduction

The satisfactory operation of the ERCOT System (equipment operated above 60 kV), especially under abnormal conditions, is greatly influenced by protective relay system.

Protective relay systems are defined as the total combination of:

- The protective relays,
- Associated communications system,
- Voltage and current sensing devices, and,
- The dc system up to the terminals in the circuit breaker.

Although relaying of tie points between Facility Owners is of primary concern to the ERCOT System, internal protective relay system often directly, or indirectly, affects the adjacent area also. Facility Owners are those entities owning facilities in the ERCOT System. Facility Owners have an obligation to implement relay application, operation, and preventive maintenance criteria that assure the highest practicable reliability and availability of service to the ultimate power consumers of the concerned area and neighboring areas. Protective relay system of individual Facility Owners shall not adversely affect the stability of ERCOT System interconnections. Additional minimum protective relay system requirements are outlined in NERC Planning and Reliability Standards.

These objectives and design practices shall apply to all new protective relay system applied at 60 kV and above unless otherwise specified. It is recognized that there may be portions of the existing ERCOT System that do not meet these objectives. It is the responsibility of individual Facility Owners to assess the protective relay system at these locations and to make any modifications that they deem necessary. Similar assessment and judgment should be used with respect to protective relay system existing at the time of revisions to this guide. Special local conditions or considerations may necessitate the use of more stringent design criteria and practices.

### 7.2.2 Design and Operating Requirements for ERCOT System Facilities

1. Protective relay system shall be designed to provide reliability, a combination of dependability and security, so that protective relay system will perform correctly to remove faulted equipment from the ERCOT System.
2. For planned ERCOT System conditions, protective relay system shall be designed not to trip for stable swings which do not exceed the steady-state stability limit. Note that when out-of-step blocking is used in one location, a method of out-of-step tripping should also be considered. Protective relay system shall not interfere with the operation of the ERCOT System under the procedures identified in the other Operating Guides.
3. Any loading limits imposed by the protective relay system shall be documented and followed as an ERCOT System operating constraint.
4. The thermal capability of all protection system components shall be adequate to withstand the maximum short time and continuous loading conditions to which the associated protected elements may be subjected, even under first-contingency conditions.

5. Applicable IEEE/ANSI guides shall be considered when applying the protective relay system on the ERCOT System.
6. The planning and design of generation, transmission and substation configurations shall take into account the protective relay system requirements of dependability, security and simplicity. If configurations are proposed that require protective relay systems that do not conform to this guide or to accepted IEEE/ANSI practice, then the Facility owners affected shall negotiate a solution.
7. All Facility owners shall give sufficient advance notice to ERCOT of any changes to their Facilities that could require changes in the protective relay system of neighboring Facility owners.
8. Facility owner's operations personnel shall be familiar with the purposes and limitations of the protective relay system.
9. The design, coordination, and maintainability of all existing protective relay systems shall be reviewed periodically by the Facility owner to ensure that the protective relay systems continue to meet ERCOT System requirements. This review shall include the need for redundancy. Where redundant protective relay systems are required, separate AC current inputs and separately fused DC control voltages shall be provided with the upgraded protective relay system. Documentation of the review shall be maintained and supplied by the Facility owner to ERCOT or NERC on their request within 30 days. This documentation shall be reviewed by ERCOT for verification of implementation.
10. Upon ERCOT's request, within 30 days, PGCs shall provide ERCOT with the operating characteristics of any generator's equipment protective relay system or controls that may respond to temporary excursions in voltage, frequency, or loading with actions that could lead to tripping of the generator.
11. Upon ERCOT's request, within 30 days, Generation Entities shall provide ERCOT with information that describes how generator controls coordinate with the generator's short-term capabilities and the protective relay system.
12. Over-excitation limiters, when used, shall be coordinated with the thermal capability of the generator field winding. After allowing temporary field current overload, the limiter shall operate through the automatic AC voltage regulator to reduce field current to the continuous rating. Return to normal AC voltage regulation after current reduction shall be automatic. The over-excitation limiter shall be coordinated with the over-excitation protection so that over-excitation protection only operates for failure of the voltage regulator/limiter. Documentation of coordination shall be supplied, by Generation Entities, to ERCOT upon their request within 30 days.
13. Special Protection Systems (SPS) are protective relay systems designed to detect abnormal ERCOT System conditions and take pre-planned corrective action (other than the isolation of faulted elements) to provide acceptable ERCOT System performance. SPS actions include among others, changes in demand, generation, or system configuration to maintain system stability, acceptable voltages, or acceptable Facility loadings. An SPS does not include under-frequency or under-voltage Load shedding. A Type 1 SPS is any SPS that has wide-area impact and specifically includes any SPS that a) is designed to alter generation output or otherwise constrain generation or

imports over DC Ties, or b) is designed to open 345 kV transmission lines or other lines that interconnect TDSPs and impact transfer limits. Any SPS that has only local-area impact and involves only the Facilities of the owner-TDSP is a Type 2 SPS. The determination of whether an SPS is Type 1 or Type 2 will be made by ERCOT upon receipt of a description of the SPS from the SPS owner. Any SPS, whether Type 1 or Type 2, shall meet all requirements of NERC Standards relating to SPSs, and shall additionally meet the following ERCOT requirements:

- The SPS owner shall coordinate design and implementation of the SPS with the owners and operators of Facilities included in the SPS, including but not limited to Generation Resources and HVDC ties.
  - The SPS shall be automatically armed when appropriate.
  - The SPS shall not operate unnecessarily. To avoid unnecessary SPS operation, the SPS owner may provide a real-time status indication to the owner of any Generation Resource controlled by the SPS to show when the flow on one or more of the SPS's monitored facilities exceeds 90% of the flow necessary to arm the SPS. The cost necessary to provide such status indication shall be allocated as agreed by the SPS owner and the Generation Resource owner.
  - The status indication of any automatic or manual arming of the SPS shall be provided as SCADA alarm inputs to the owners of any facility(ies) controlled by the SPS..
  - When a Transmission Operator (TO) removes a SPS from service, the TO shall immediately notify ERCOT operations. ERCOT shall modify its reliability constraints to recognize the unavailability of the SPS and notify the Market. When a SPS is returned to service, the TO shall immediately notify ERCOT operations. ERCOT shall modify its reliability constraints to recognize the availability of the SPS.
14. The owner(s) of an existing, modified, or proposed SPS shall submit documentation of the SPS to ERCOT for review and compilation into an ERCOT SPS database. The documentation shall detail the design, operation, functional testing, and coordination of the SPS with other protection and control systems.
- ERCOT shall conduct a review of each proposed SPS and each proposed modification to an existing SPS. Additionally, it shall conduct a review of each existing SPS every five years, or sooner as required by changes in system conditions. Each review shall proceed according to a process and timetable documented in ERCOT Procedures and posted on the ERCOT website.
  - For a proposed Type 1 SPS, the review must be completed before the SPS is placed in service, unless ERCOT specifically determines that exemption of the proposed SPS from the review completion requirement is warranted. The timing of placing the SPS into service must be coordinated with and approved by ERCOT. The implementation schedule must be confirmed through submission of a Service Request to ERCOT.
  - For a proposed Type 2 SPS, the SPS may be placed into service before completion of the ERCOT review, with advanced prior notice to ERCOT in the form of a Service Request. The timing of placing the SPS into service must be coordinated with and approved by ERCOT. Existing SPSs that have already undergone at least

one review shall remain in service during any subsequent review, and proposed modifications to existing SPSs may be implemented, upon notice to ERCOT, and approval of ERCOT before completion of the required ERCOT review.

- The process and schedule for placing an SPS into service must be consistent with documented ERCOT Procedures. The schedule must be coordinated among ERCOT and the owners of any facility(ies) controlled by the SPS, and shall provide sufficient time to perform any necessary testing prior to its being placed in service.
  - An ERCOT SPS review shall verify that the SPS complies with ERCOT and NERC criteria, guides, and Reliability Standards. The review shall evaluate and document the consequences of failure of a single component of the SPS, which would result in failure of the SPS to operate when required. The review shall also evaluate and document the consequences of misoperation, incorrect operation, or unintended operation of an SPS, when considered by itself, and without any other system contingency. If deficiencies are identified, a plan to correct the deficiencies shall be developed and implemented. The current review results shall be kept on file and supplied to NERC on request within thirty (30) days.
  - As part of the ERCOT review and unless judged to be unnecessary by ERCOT, the appropriate ROS working groups such as the Steady State Working Group, the Dynamics Working Group, and/or the System Protection Working Group shall review the SPS and report any comments, questions, or issues to ERCOT for resolution. ERCOT may work with the owner(s) of facilities controlled by the SPS as necessary to address all issues.
  - ERCOT shall develop a methodology to include the SPS in the Commercially Significant Constraint (CSC) limit calculations, if appropriate.
  - ERCOT's review shall provide an opportunity for and include consideration of comments submitted by Market Participants affected by the SPS.
15. SPS owners shall notify ERCOT of all SPS operations. Documentation of SPS failures or misoperations shall be provided to ERCOT using the Relay Misoperation Report located in Section 6 of these Operating Guides. ERCOT shall conduct an analysis of all SPS operations, misoperations, and failures. If deficiencies are identified, a plan to correct the deficiencies shall be developed and implemented.
16. For each SPS, the owner shall either identify a preferred exit strategy or explain why no exit strategy is needed to ERCOT. This shall take place according to a timetable documented in ERCOT Procedures and posted on the ERCOT website. Once an exit strategy is complete and a SPS is no longer needed, the owner of an existing SPS shall notify ERCOT, using a Service Request, whenever the SPS is to be permanently disabled, and shall do so according to a timetable coordinated with and approved by ERCOT and the owners of all facilities controlled by the SPS.

### **7.2.3 Performance Analysis Requirements for ERCOT System Facilities**

1. All ERCOT System disturbances (unwanted trips, faults, and protective relay system operations) shall be analyzed by the affected Facility Owner promptly and any deficiencies investigated and corrected.
2. All protective relay system misoperations in systems 100 kV and above shall be documented, including corrective actions and the documentation supplied by the affected

Facility Owner to ERCOT or NERC upon their request within five business days. All protective relay system misoperations shall be documented using Section 6.1.2, Relay Misoperation Report. Any of the following events constitute a reportable protective relay system misoperation:

- Failure to Trip – Any failure of a protective relay system to initiate a trip to the appropriate terminal when a fault is within the intended zone of protection of the device.
  - Slow Trip – A correct operation of a protective relay system for a fault in the intended zone of protection where the relay system initiates tripping slower than the system design intends.
  - Unnecessary Trip During a Fault – Any relay initiated operation of a circuit breaker during a fault when the fault is outside the intended zone of protection.
  - Unnecessary Trip Other Than Fault – The unintentional operation of a protective relay system, which causes a circuit breaker to trip when no system fault is present. May be due to vibration, improper settings; load swing, defective relays, or SCADA system malfunction.
  - Employee action that directly initiates a trip is not included in this category. It is the intent of this reporting process to identify misoperations of the relay system as it interrelates with the electrical system, not as it interrelates to personnel involved with the relay system. With this in mind, if an individual directly initiates an operation, it is not counted as a misoperation (i.e., unintentional operation during tests). On the other hand, if a technician leaves trip test switches or cut-off switches in an inappropriate position and a system fault or condition causes a misoperation, this would be counted as a relay system misoperation
  - Failure to Reclose – Any failure of a protective relay system to automatically reclose following a fault if that is the design intent.
3. All SPS misoperations shall be documented, including corrective actions and the documentation supplied to ERCOT and NERC upon request within five business days. All SPS misoperations shall be documented using Section 6.1.2, Relay Misoperation Report. Any of the following events constitute a reportable SPS misoperation:
- Failure to Operate – Any failure of a SPS to perform its intended function within the designed time when system conditions intended to trigger the SPS occur.
  - Failure to Arm – Any failure of a SPS to automatically arm itself for system conditions that are intended to result in the SPS being automatically armed.
  - Unnecessary Operation – Any operation of a SPS that occurs without the occurrence of the intended system trigger condition(s).
  - Unnecessary Arming – Any automatic arming of a SPS that occurs without the occurrence of the intended arming system condition(s).
  - Failure to Reset – Any failure of a SPS to automatically reset following a return of normal system conditions if that is the design intent.
4. Facility Owners shall document the performance of their protective relay system utilizing the method described in the paper “Transmission Protective Relay System Performance Measuring Methodology”, IEEE/PSRC Working Group 13 September 16, 1999. Facility Owners shall report the performance of their 138 kV and 345 kV protective relay system

for the previous twelve months to ERCOT on an annual basis. The reporting period shall be from May 1 of the previous year through April 30 of the present year. The performance data reported shall include the total number of protective relay system misoperations, the total number of events, and the factor “k”.

5. At least annually, ERCOT shall review the protective relay system misoperation reports and 345 kV performance data of Facility Owners for analysis of protective relay system performance and compliance.
6. All Facility owners shall install, maintain, and operate disturbance monitoring equipment in accordance with the requirements in Section 7.1.2.3, Data Recording Requirements.
7. Facility owners shall provide an assessment of the system performance results of simulation tests of the contingencies in Table I of the NERC Planning Standard I.A. These assessments should be based on existing protection systems and any existing backup or redundancy protection systems to determine that existing transmission protection systems are sufficient to meet the system performance levels as defined in NERC Planning Standard I.A. and the associated Table I. All non-compliance findings shall be documented, including a plan for achieving compliance. These assessments shall be provided to NERC or ERCOT on their request within 30 days.

#### **7.2.4 Maintenance and Testing Requirements for ERCOT System Facilities**

1. The Facility Owner shall test and verify the operation of each new or modified protective relay system prior to placing the equipment in its zone of protection in service.
2. Facility Owners shall have documented protective relay system maintenance and testing programs in place. Documentation shall include identification of protective relay system, a summary of testing procedures including requirements for frequency of tests, and the date last tested.
3. The Facility Owner shall periodically test and inspect all components of the protective relay system to assure continued reliability. Identified deficiencies shall be corrected. Documentation demonstrating compliance with the Facility Owner’s maintenance and testing programs shall be supplied to ERCOT or NERC upon their request within 30 days.

#### **7.2.5 Requirements and Recommendations for ERCOT System Facilities**

##### **7.2.5.1 General Protection Criteria**

##### ***Dependability***

1. Except as noted in Sections 4 and 5 below, all elements of the ERCOT System operated at 100 kV and above (i.e., lines, buses, transformers, generators, breakers, capacitor banks, etc.) shall be protected by two protective relay systems. Each protective relay system shall be independently capable of detecting and isolating all faults thereon.
2. The protective relay system design should avoid the use of components common to the two protective relay systems. Areas of common exposure should be kept to a minimum to reduce the possibility of both protective relay systems being disabled by a single contingency.

3. The use of two identical protective relay systems is not generally recommended, due to the risk of simultaneous failure of both protective relay systems because of design deficiencies or equipment problems.
4. Breaker failure protection should be provided to trip all necessary local and remote breakers in the event that a breaker fails to clear a fault. This protection need not be duplicated.
5. On installations where freestanding or column-type current transformers are provided on one side of the breaker only, the protective relay system should be provided to detect a fault on the primaries of such current transformers. This protection need not be duplicated. Application of freestanding CTs requires extra care to ensure that the relaying is proper and that the schemes overlap.

### ***Security***

The protective relay system should be designed to isolate only the faulted element, except in those circumstances where additional elements should be tripped intentionally to preserve system integrity. For faults external to the protected zone, each protective relay system should be designed to either not operate, or to operate selectively with other systems, including breaker failure. (In this context, the limits of the protected zone are defined by the circuit breakers.)

### ***Dependability and Security***

1. The protective relay system should be no more complex than required for any given application.
2. To the maximum degree practicable, the components used in the protective relay system should be of proven quality, as demonstrated either by actual experience or by stringent tests under simulated operating conditions, to ensure that the reliability of the protective relay system is not degraded by the components.
3. The protective relay system shall be designed to minimize the possibility of component failure or malfunction due to electrical transients and electromagnetic interference or external effects such as vibration, shock and temperature.
4. Critical features associated with protective relay system and circuit breaker operation shall be annunciated or monitored.
5. The protective relay system circuitry and physical arrangements shall be carefully designed so as to minimize the possibility of incorrect operations due to personnel error.
6. Computerized fault studies shall be used during the planning or design stages to analyze the effects of an addition or modification to the ERCOT system and to determine proper protective relay system coordination.

### ***Operating Time***

The objective of the protective relay system is to take corrective action in the shortest practical time with due regard to selectivity, dependability and security. In cases where clearing times are deliberately extended, consideration should be given to the following:

1. Effect on ERCOT System stability or reduction of stability margins.

2. Possibility of causing or increasing damage to equipment and subsequent extended repair and/or outage time.
3. Effect of disturbances on service to customers and neighboring Facility Owners.

### **Testing and Maintenance**

1. The design of the protective relay system both in terms of circuitry and physical arrangement shall facilitate periodic testing and maintenance. Test devices or switches should be provided to eliminate the necessity for removing or disconnecting wires during periodic testing.
2. Commissioning of new equipment should consist of the following steps:
  - Relay installation wiring diagrams cross-checked against schematics
    - After completion of construction, physical check of wiring and relay installation
    - Check and testing before energizing of all equipment in the zone of protection, including relay testing. It is desirable to test the relays at the setting the relay will have in service
    - Check of supporting paperwork, such as relay test reports
    - Check that the relay settings when received from the manufacturer concur with the intended manufacturer's specifications
    - Calibrate and check that proper utility's settings have been made
    - Maintain a record of trip check and energizing procedure performance
    - Maintain a record of in-service measurement of voltage, current magnitudes, phase angles, and a comparison to expected values and to other instrumentation
    - Release to Facility Owner for service

### **Analysis of System Performance and Associated Protection Systems**

1. Relay operation and settings shall be reviewed periodically and whenever significant changes in generating sources, transmission facilities, or operating conditions are anticipated.
2. Naturally occurring faults and other system disturbances should be analyzed as a source of information as to the health of relay schemes in the System. Sources of information usually available are:
  - Short circuit study for the exact conditions of the fault
  - Fault recorder traces
  - Sequence of events data recording the opening and closing of contacts in the protective relay scheme and associated communication equipment
  - Fault locator data
  - SCADA (Supervisory Control And Data Acquisition) logger output of breaker operation and alarms
  - Interviews with operating personnel and/or other witnesses
  - Field report of relay flags and breaker counter changes
  - Field report of the fault location, if found



- Records of relay setting, relay testing, trip check and energize procedures as carried out, in-service measurements, relay wiring diagrams and schematics, manufacturers' information
  - Other coworkers and System Protection Working Group members
  - Manufacturers' application and design engineers
3. Steps one can follow in analyzing a disturbance are:
- Gather data
  - Create a time line consisting of events and periods between events
  - Compare actual and calculated values of current and voltage during the periods between events
  - Compare actual and expected breaker operations and flags
  - Choose the least complicated explanation for contradictory information and to fill in missing information
  - Gather additional information as indicated to prove or disprove explanations
  - Iterate
  - Document by issuing a report of all findings, changes, and recommendations
  - After a reasonable time, check back to see if the recommendations have been carried out

### **7.2.5.2 Equipment and Design Considerations**

#### ***Current Transformers***

1. Current transformers (CTs) associated with the protective relay system shall have adequate steady state and transient characteristics for their intended function.
2. The output of each current transformer shall remain within acceptable limits for the connected burdens under all anticipated fault currents to ensure correct operation of the protective relay system.
3. Current transformers or their secondary windings shall be located so that adjacent protection zones overlap.
4. Current transformer secondary wiring shall be grounded at only one point. When multiple current transformers are interconnected, the combination shall have only one ground.
5. Other considerations:
  - Internal bushing CTs are preferred over external slip-over CTs
  - 10L800 (C800) class CTs are preferred for relaying
  - Breakers and free-standing CTs with four or more sets of CTs are preferred
  - Over-the-bushing external CTs can sometimes solve problems when there aren't enough CTs. Note that there may be an unprotected region between the external CT and the bushing CT.
  - Shorting type terminal blocks should be provided for all CTs

#### ***Voltage Transformers and Potential Devices***

1. Voltage transformers (VTs) and potential devices associated with the protective relay system shall have adequate steady state and transient characteristics for their intended functions.
2. Voltage transformers and potential devices shall have adequate volt-ampere capacity to supply the connected burden while maintaining their relay accuracy over their specified primary voltage range.
3. Usually one set of VTs (with two separate secondary windings per VT) per bus (i.e. single bus substation configuration) or per power system element (i.e. ring bus and breaker-and-a-half substation configurations) is sufficient. The two protective relay systems protecting ERCOT System facilities may use separate secondary windings of the VTs or one of the secondary windings may be dedicated to supplying the polarizing potential and the other winding used to supply other protection and monitoring functions.
4. Voltage transformer and potential device secondary wiring shall be grounded at only one point. (ANSI/IEEE C57 recommends grounding at the panel.)
5. Voltage transformer installations shall be designed with due regard to ferroresonance due to capacitance across the interrupter at 138kV and above.
6. Other considerations
  - Special attention should be given to the physical properties of secondary circuit fuses
  - Capacitor coupled voltage transformers are suitable for relaying and SCADA telemetry
  - Report loss of VT voltage (VT fuse failure) over SCADA

### ***Batteries and Direct Current (DC) Supply***

1. DC batteries associated with the protective relay system shall have a high degree of reliability.
2. Two batteries each with its own charger should be provided at each location. An acceptable alternative is one battery with two separately protected branches. The systems protecting a zone shall be supplied from the separate sources or branches. For a new facility, two batteries shall be required in locations that remote backup clearing of lines and substation faults is not achieved. Where only one battery is used, remote backup clearing of line and substation faults is required.
3. Each battery shall have sufficient capacity to permit operation of the station, in the event of a loss of its battery charger or the AC supply source, for the period of time necessary to transfer the load to the other battery or to re-establish the supply source. Each battery and its associated charger shall have sufficient capacity to supply its share of the DC load of the station.
4. A fault at the battery terminals can only be interrupted by a mid-bank protective device. If a mid-bank protective device is not used, then the connections between the battery terminals and the main protective devices shall possess the highest possible degree of reliability.

5. The battery chargers and all associated circuits shall be protected against short circuits. All protective devices shall be coordinated to minimize the number of DC circuits interrupted.
6. The regulation of DC voltage shall be designed such that, under all possible loading conditions, voltage within acceptable limits will be supplied to all devices.
7. DC systems shall be monitored to detect abnormal voltage levels, both high and low, DC grounds, and loss of AC to the battery chargers. Loss of DC to relay schemes shall be alarmed. Also, where possible the loss of AC to the battery chargers and loss of DC should be provided as SCADA alarm inputs.
8. DC systems shall be designed to minimize AC ripple and voltage transients.
9. The DC circuit protective devices used shall have published DC interrupting ratings suitable for the required circuit duty.

### ***AC Auxiliary Power***

1. There should be two sources of station service AC supply, each capable of carrying all the critical loads associated with the protective relay system.
2. Failure of station service AC supply should be alarmed over SCADA.

### ***Circuit Breakers***

1. Two trip coils, one associated with each protection system, shall be provided for each operating mechanism. The failure of one coil shall not damage or impair the operation of the other coil.
2. The design shall be such that the breaker will operate if either both trip coils are energized simultaneously, or either trip coil alone, and verified by tests.
3. Circuit breaker auxiliary switches used in protection systems should be highly reliable with a positive make-break action and good contact wipe. Multiplier contacts simulating breaker auxiliary switches should be used with caution in protection systems.
4. A three-phase and line-to-ground interrupting study to validate or indicate breaker interrupting rating shall be performed.

### ***Communications Channels***

1. Where communication channels are required for the protective relay system purposes, the communication facilities shall have a degree of reliability no less than that of the other protective relay system components. For extra security, the output contacts from two independent channels may be wired in series.
2. Where communication channels are required in each of the two protective relay systems, the channels shall be separated physically and designed to minimize the risk of both channels being disabled simultaneously by a single contingency.
3. Communication channels shall be provided with means to verify signal performance.
4. Other considerations
  - Report loss of channel over SCADA

- Automatic testing of power line carrier (PLC) is desirable to reduce false trips from failure to block
- Split up PLC loads between DC sources so that loss of one fuse does not disable all the carrier sets. If all the carrier sets were to be disabled, then multiple false trips during a fault could result.

### **Control Cables and Wiring**

1. Control cables, wiring and auxiliary control devices should be such as to assure high reliability with due consideration to published codes and standards, fire hazards, current-carrying capacity, voltage drop, insulation level, mechanical strength, routing, shielding, grounding and environment.
2. Other considerations
  - Shielded cable may be necessary for certain relay and SCADA applications
  - AC or DC go-and-return functions should be implemented in the same cable to avoid induction loops
  - Individual wires in cables should have colored jackets, not black jackets with a "color" printed on the jacket
  - Standardization of the relationship between wire colors and functions is desirable
  - No splice in any wire or cable
  - All cables terminated on terminal blocks

### **Environment**

1. Means shall be employed to maintain environmental conditions that are favorable to the correct performance of the protective relay system. Particular attention should be given to solid-state equipment installations.
2. Other environmental hazards to look out for:

➤ Fire ants	➤ Rats
➤ Snakes	➤ Dust, dirt, grime
➤ Trash and leftover hardware	➤ Water
➤ Gunfire	➤ Theft of substation and transmission grounds
➤ Hand-held radio keyed near solid-state relays	➤ Batteries located in same room as relays (battery fires)
➤ Severe cold weather conditions can impact operation of circuit breakers, DC battery, and	

carrier signals.	
------------------	--

### 7.2.5.3 Specific Application Considerations

#### ***Transmission Line Protection***

1. Each of the two independent protective relay systems shall detect and initiate action to clear any line fault without undue system disturbance. The protective relay system shall operate for line faults so that, if ultimate clearing should be accomplished by a breaker failure scheme, a widespread disturbance will not result. A protective relay system, which can operate for faults beyond the zone it is designed to protect, shall be selective in time with other protective relay system, including breaker failure.
2. Transmission line protection should consist of:
  - Primary phase and ground protection over a communications channel.
  - Backup relaying with at least two zones of phase protection.
  - Backup relaying with at least two zones of ground protection, or backup relaying with ground directional overcurrent relaying (time delay and instantaneous).
  - "Ground chain protection" to recognize and trip for a three-phase fault right at the terminals, in service for a short period of time just as the line is energized, for lines with line side VTs.
  - Recognition and trip for open conductor is desirable but not required.
  - Overload protection is provided by SCADA analog alarms and dispatcher discretion.
  - Fault detector relays to supervise phase distance relaying to prevent inadvertent trip due to VT failure.
  - Short lines may require special attention, such as dual primary schemes, etc.
  - Fuses shall not be used in the 3Vo polarizing supply for ground relays.
  - The setting for synchronization check relays should be based on system studies that identify the voltage angles necessary for a successful re-close.

#### ***Transmission Station Protection***

1. Each zone in a station shall be protected by two independent protective relay systems. For zones not protected by line protection, at least one of the two protective relay systems shall be a differential type.
2. The protective relay system shall be designed to operate for station faults so that, if ultimate clearing is accomplished by a breaker failure scheme, a widespread disturbance will not result. The protective relay system shall be designed to operate properly for the anticipated range of currents.
3. Station protection should consist of:
  - Bus differential or bus overcurrent protection of all buses

- All transformers protected by transformer differential, transformer overcurrent, or fuses (for small transformers). Note that ferroresonance is possible for fused transformers above 69kV.
- Sudden pressure relay protection for transformer main tanks and transformer tap changer compartments

### ***Breaker Failure Protection***

1. Breaker failure protection should be provided to trip all necessary local and remote breakers in the event that a breaker fails to clear a fault.
2. The breaker failure protection should be initiated by each of the protection systems that trip that breaker. It is not necessary to duplicate the breaker failure protection itself.
3. Induction cup or solid state fault current detectors shall be used to determine if a breaker has failed to interrupt.
4. Plunger or clapper type overcurrent relays are not recommended as breaker failure fault detectors.

### ***Generator Protection***

1. Generator faults shall be detected by more than one protective relay system. These may include faults in the generator or generator leads, unit transformer, and unit-connected station service transformer.
2. Generators shall be protected to keep damage to the equipment and subsequent outage time to a minimum. In view of the special consideration of generator unit protection, the following are some of the conditions that should be detected by the protection systems:
  - Unbalanced phase currents
  - Loss of excitation
  - Over-excitation
  - Field ground
  - Inadvertent energization (reverse power)
  - Uncleared system faults
  - Off-frequency

It is recognized that the overall protection of a generator will also involve non-electrical considerations. These have not been included as part of this criteria.

3. The apparatus shall be protected when the generator is starting up or shutting down as well as running at normal speed; this may require additional relays, as the normal relays may not function satisfactorily at low frequencies.
4. A generator shall not be tripped for a system swing condition except when that particular generator is out of step with the remainder of the system. This does not apply to protective relay system designed to trip the generator as part of an overall plan to maintain stability of the ERCOT System.
5. The loss of excitation relay shall be set with due regard to the performance of the excitation system.

### ***Automatic Under-Frequency Load Shedding (UFLS) Protection Systems***

Automatic under-frequency Load shedding systems are classified as protective relay systems. The maintenance requirements, discussed in Section 7.2.4, Maintenance and Testing Requirements for ERCOT System Facilities, apply to under-frequency Load shedding protection systems as well.

1. Automatic under-frequency Load shedding systems are generally located on equipment operated below 60 kV; however, they have a direct effect on the operation of the system during major emergencies.
2. The criteria for the operation of these protection systems are detailed in Section 2.9, Requirements for Under-Frequency Relaying.
3. Automatic under-frequency Load shedding protection systems need not be duplicated.
4. Generator and turbine under-frequency protection systems shall be coordinated with Section 2.9, Requirements for Under-Frequency Relaying.
5. On pressurized water reactor steam supply units where under-frequency related protection systems are installed to detect loss of coolant flow condition, these protection systems shall be coordinated with the automatic under-frequency Load shedding program.
6. Automatic Load restoration for a UFLS operation is not currently utilized in ERCOT.

### ***Automatic Under-Voltage Load Shedding Protection Systems***

Automatic under-voltage Load shedding systems are classified as protective relay systems. The maintenance requirements, discussed in Section 7.2.4, Maintenance and Testing Requirements for ERCOT System Facilities, apply to under-voltage Load shedding protection systems as well.

1. The requirement for under-voltage relaying shall be determined by system studies performed/administered by ERCOT designated working groups or equipment owners. The system studies should indicate the following:
  - Amount of Load to be shed to restore voltage to minimum acceptable level or higher,
  - The minimum and maximum time delay allowed before automatically shedding Load,
  - The voltage level(s) at which to initiate automatic relay operation, and
  - The location(s) for effectively applying under-voltage Load shedding protection systems.
2. Automatic under-voltage Load shedding protection systems need not be duplicated.
3. Analyses shall be performed on under-voltage Load shedding schemes by working groups and/or equipment owners as assigned by ERCOT to demonstrate that they are expected to act before generators trip Off-line due to the protective relay requirements described in Section 3.1.4.6, Protective Relaying Requirement. A specific exemption from this analysis requirement may be provided by the ERCOT Reliability and Operations Subcommittee (ROS).

4. Under-voltage protection systems shall be designed to coordinate with other protective devices and control schemes during momentary voltage dips, sustained faults, low voltages caused by stalled motors, motor starting, etc.
5. Automatic Load restoration for a UVLS operation is not currently utilized in ERCOT.
6. The scheme shall be designed to ensure reliable operation and to prevent false tripping.



## 7.3 Document Control

### *Change History*

ISSUE/DATE	REASON FOR ISSUE
Version 0.1 December 7, 2000	Draft for Review
Version 0.2 December 29, 2000	Insert comments
Version 0.3 January 19, 2001	Insert comments from seminar
Version 0.4 February 5, 2001	Comments from second Working Group
Version 1.0 February 28, 2001	Updated from Working Group comments. Submitted to Technical Advisory Committee to approve handover to the Reliability Operating Subcommittee
May 1, 2002	OGRR103
July 1, 2002	OGRR104
September 1, 2002	OGRR107 & OGRR109
December 1, 2002	Reformatted numbering from Appendix B to Section 7.
January 1, 2003	OGRR121 revised Section 7.2.2.5 for fault recording equipment.
March 1, 2003	Formatted header and page numbering.
May 1, 2003	Moved "Planning" text to Section 5 and updated section numbering.
February 1, 2004	OGRR140 updated Section 7.2.2
May 1, 2004	OGRR144 updated Section 7.2.5.3
May 1, 2005	OGRR162
April 1, 2006	OGRR172
August 1, 2006	OGRR179
July 1, 2007	Admin OGRR201

---

---

# ***ERCOT OPERATING GUIDES***

---

---

## **Section 8: Operational Metering and Communication**

---

---

### **ERCOT Real Time Operational Metering and Communication**

June 8, 2009

**PUBLIC**

# Contents

<b>8</b>	<b>OPERATIONAL METERING AND COMMUNICATION .....</b>	<b>8-3</b>
8.1	OPERATIONAL METERING .....	8-3
8.1.1	<i>ERCOT Interface RTUs</i> .....	8-4
8.1.2	<i>ERCOT ICCP Interface</i> .....	8-4
8.1.3	<i>Validation of Real Time Signals with Settlement Metering for Resources</i> .....	8-4
8.1.4	<i>Data from ERCOT to QSE's</i> .....	8-4
8.1.5	<i>Data From ERCOT to TDSP</i> .....	8-5
8.1.6	<i>Data from QSE/TDSP to ERCOT</i> .....	8-5
8.1.7	<i>TDSP/QSE Metering Restoration</i> .....	8-8
8.1.8	<i>QSE and TDSP Data Acquisition</i> .....	8-8
8.2	CALIBRATION AND TESTING .....	8-8
8.2.1	<i>Responsibility</i> .....	8-8
8.2.2	<i>Notification</i> .....	8-8
8.2.3	<i>Test Equipment</i> .....	8-9
8.2.4	<i>Disputes</i> .....	8-9
8.2.5	<i>Calibration Testing</i> .....	8-9
8.2.6	<i>Exchange of Information</i> .....	8-9
8.2.7	<i>Documentation</i> .....	8-9
8.2.8	<i>Operator One-line Displays</i> .....	8-11
8.2.9	<i>Notification of Changes</i> .....	8-11
8.3	COMMUNICATIONS .....	8-12
8.3.1	<i>ERCOT WAN</i> .....	8-12
8.3.2	<i>ERCOT Responsibilities</i> .....	8-15
8.3.3	<i>QSE and TDSP Responsibilities</i> .....	8-15
8.3.4	<i>TDSP and QSE Supplied Communications</i> .....	8-17
8.3.5	<i>Maintenance and Restoration</i> .....	8-17
8.4	DOCUMENT CONTROL .....	8-19
	ATTACHMENT 8A: ERCOT DATA SETS.....	8-21

## Protocol References

REFERENCE: PROTOCOL SECTION 12.4.4.1.1, QSE, RESOURCE AND TDSP RESPONSIBILITIES .....	8-3
REFERENCE: PROTOCOL SECTION 12.4.4.1.2, ERCOT RESPONSIBILITIES .....	8-5
REFERENCE: PROTOCOLS SECTION 8.8.1, COORDINATION WITH ERCOT.....	8-9
REFERENCE: PROTOCOLS SECTION 8.8.2.1, TSP INFORMATION TO BE PROVIDED TO ERCOT .....	8-10
REFERENCE: PROTOCOLS SECTION 8.8.2.3, CHANGES TO WORK APPROVED BY ERCOT. ....	8-11

## 8 Operational Metering and Communication

### 8.1 Operational Metering

Qualified Scheduling Entity (QSE) control centers supply operational metering data to ERCOT and receive signals from ERCOT to implement frequency control. The QSE's interface to ERCOT for this purpose is implemented through a QSE-supplied Inter-Control Center Communications Protocol (ICCP) interface at the QSE control center. Optionally, a QSE may continue to use a legacy Distributed Network Protocol (DNP) 3.0 protocol interface. However, an ICCP interface must be established for all new interconnections.

Transmission and/or Distribution Service Providers (TDSPs) supplying operational metering to ERCOT shall use an ICCP interface through the ERCOT Wide Area Network (WAN).

Each QSE or TDSP shall continuously provide the data quantities that they are responsible for providing to ERCOT. The frequency of update, means of communication to ERCOT, and format for each point shall also be as specified in Attachment 8A, ERCOT Data Sets, for that Entity, unless approved by ERCOT. At the frequency specified in the Tables, each update cycle shall provide new readings of all data points being monitored, not averages linked to prior cycle readings or repetition of readings from a previous cycle. Inaccuracy for data points as delivered to ERCOT, when compared with actual quantity measured at the source, shall be no greater than four percent (4%).

***REFERENCE: PROTOCOL SECTION 12.4.4.1.1, QSE, RESOURCE AND TDSP RESPONSIBILITIES***

*QSEs, Resources and TDSPs are required to provide power operation data to ERCOT including, but not limited to:*

- (1) *Real time generation data from QSEs;*
- (2) *Planned Outage information from Resources;*
- (3) *Network data used by any TDSP's control center, including:*
  - (a) *Breaker and line switch status of all ERCOT Transmission Grid devices;*
  - (b) *Line flow MW and MVAR;*
  - (c) *Breaker, switches connected to all Resources;*
  - (d) *Transmission Facility Voltages; and*
  - (e) *Transformer MW, MVAR and TAP.*
- (4) *Real time generation and Load acting as a Resource meter data from QSEs;*
- (5) *Real time Generation meter splitting signal from QSEs;*
- (6) *Planned Transmission Outage information from TDSP;*
- (7) *Network transmission data (model and constraints) from TDSP;*
- (8) *Resource Plans from QSE; and*
- (9) *Dynamic Schedules from QSEs;*

*Real Time data will be provided to ERCOT at the same scan rate as the TDSP or QSE obtains the data from telemetry.*

### **8.1.1 ERCOT Interface RTUs**

ERCOT interface Remote Terminal Units (RTUs) pass communications between the Market Participant responsible for supplying Operational Metering data and ERCOT. Suppliers of data must install and configure these RTUs according to ERCOT procedures. The RTU or other device shall reflect the data quality codes (i.e., suspect, failed, manual, etc.) of the individual data points found in the Market Participant's control computers and data collection systems.

In order to ensure that Real Time data can be exchanged in a timely manner, the connection concept has been extended to support the use of specified communications protocols. The connection is designed around the following requirements:

The connection paths begin with the Market Participant's RTU or Supervisory Control And Data Acquisition (SCADA) system. ICCP connections will be over the data portions of the point-to-point network and the frame relay network. The DNP 3.0 will be to the point-to-point network passed through a modem, and the modulated signal connects to the Market Participant's channel bank. Voice circuits to be placed on the point-to-point network are combined with the data circuit on a Fractional T1.

This connection design supports redundancy for both data exchange and voice circuits between the Market Participant and ERCOT. Data exchange redundancy is provided as described here. The Public Switched Telephone Network (PSTN) provides backup for voice circuits.

### **8.1.2 ERCOT ICCP Interface**

Inter-Control Area Communications Protocol (ICCP) over Ethernet provides Operational Metering data from Market Participant computers, computer networks, or other devices to the ERCOT WAN. Suppliers of data using an ICCP link must format their data and coordinate installation according to ERCOT procedures. The data furnished by a Market Participant's ICCP link shall reflect the data quality codes (ie, suspect, failed, manual, etc) of the individual data points found in the Market Participant's control computers and data collection system.

### **8.1.3 Validation of Real Time Signals with Settlement Metering for Resources**

The integrated real time MW signal obtained from a resource shall be validated.

Signals from resources used to supply power or ancillary services shall be integrated by ERCOT and checked against settlement meter values on a monthly basis.

Where multiple generators share a single net settlement meter, the ratio of integrated real time signals from each generator shall be used to proportion the settlement total quantity.

### **8.1.4 Data from ERCOT to QSE's**

ERCOT shall issue instructions and information to QSE's in accordance with the Operating Guide and the Protocols. Attachment 8A provides the instructional and informational data sets that ERCOT will send to the QSEs to satisfy the requirements in the Operating Guides and the Protocols.

### 8.1.5 Data From ERCOT to TDSP

ERCOT will provide operational data and issue instructions to the TDSP in accordance with the Operating Guide and the Protocols.

**REFERENCE: PROTOCOL SECTION 12.4.4.1.2, ERCOT RESPONSIBILITIES**

*ERCOT is required to provide the following power operation data to TDSPs, in accordance with confidentiality as defined in Section 1.3, Confidentiality, of these Protocols:*

- (1) *Relevant information for the purpose of providing reliability as determined by ERCOT, including but not limited to:*
  - (a) *Status of any breakers and switches in ERCOT's Real Time data base;*
  - (b) *State estimator solutions;*
  - (c) *Transmission line flows and voltages;*
  - (d) *Transformer information;*
  - (e) *QSE Resource data; and*
  - (f) *Voltage schedules at major transmission busses;*
- (2) *Interval meter data for Load and generation. This data shall include meter data measured at points of injection and points of delivery which will measurably impact the TDSP's planning and operations as determined by ERCOT Staff (e.g., determination of TDSP's system Load or power flows).*

*ERCOT will give notice to the Entities supplying the above list of data to ERCOT upon the initial provision of such data to the TDSP.*

### 8.1.6 Data from QSE/TDSP to ERCOT

QSEs and TDSPs shall provide Real Time monitoring of power system quantities to ERCOT as defined in the Operating Guides and Protocols. Attachment 8A gives the format and parameters for the content of each type of data point that ERCOT may request from TDSPs and QSEs to satisfy the requirements in the Operating Guides and the Protocols. Not all points in Attachment 8A are necessarily required from each Entity. ERCOT will inform TDSPs and QSEs if additions to presently furnished data are required. All involved parties will seek to jointly resolve a means and schedule for providing data to ERCOT, including changes to existing data. ERCOT will consider alternatives and exceptions, on a case-by-case basis, to the extent that ERCOT does not believe its operational needs are compromised. Ultimately, it is the responsibility of the TDSPs and QSEs to provide all data requested by ERCOT as set forth in the ERCOT Protocols and Operating Guides.

#### 8.1.6.1 Weather Zone Data

If the TDSP is responsible for providing Weather Zone data, they are required to establish a backup to the primary source as follows:

TDSPs having an Energy Management System (EMS) with a native ICCP application capable of four (4) second periodic data set transfers with minimum three hundred (300) points per data set, and hot standby backup ICCP servers with automatic fail-over capability, shall provide an additional ICCP association across the ERCOT WAN for the transfer of Weather Zone tie line measurements. ICCP nodes should exist at primary and backup facilities.

### **8.1.6.2 State Estimator Data**

ERCOT uses a state estimator to produce load flow base cases which are used to analyze the reliability of the transmission grid. The state estimator is dependent on accurate MW, MVAR, and voltage telemetry in determining the current transmission conditions. The state estimator results are used in contingency analysis and also in transmission congestion management.

ERCOT may request additional telemetry when it determines that network observability or the measurement redundancy is not adequate to produce accurate results for the safe and reliable operation of the transmission system,

#### **8.1.6.2.1 *Telemetry Requests for Observability***

ERCOT is required to protect transmission assets operated at 60 kV or above from damage. To do this, ERCOT may request that additional MW, MVAR, and voltage telemetry be installed, while attempting to minimize adding equipment to as few locations as practicable.

Prior to making a request for additional telemetry, ERCOT will perform a contingency analysis study that identifies proposed telemetry, expected improvements in system observability and the relevant post-contingency overloads or under/over voltage conditions that cannot be analyzed using existing telemetry. If the request is for telemetry additions at more than one location, ERCOT will prioritize the requested additions.

Upon receipt of a request for additional telemetry, the TDSP or QSE will have sixty (60) days to either:

- (1) Accept ERCOT's request for additional telemetry and provide a schedule for its implementation;
- (2) Provide an alternative proposal to ERCOT, for implementation within the next 18 months, which meets the requirements described by ERCOT;
- (3) Propose a normal topology change (change normal status of switch (es)) in the area which would eliminate the security violations which are ERCOT's concern. (i.e. eliminates the possibility of flow through a networked element and turns the security problem into a planning problem which is un-affected by unit dispatch);
- (4) Indicate that the requested telemetry point is at a location where the TDSP or QSE does not have the authority to install the requested telemetry. For points on privately owned facilities connected to the ERCOT Transmission Grid, an attempt will be made to facilitate ERCOT's telemetry request; or

- (5) File a request with the PUCT requesting expedited action for an Order directing that the responsibility for reliability and protection of this specific element or elements of the transmission system be withdrawn from ERCOT and assigned to the requesting TDSP. ERCOT will then immediately remove the elements from its Real Time Congestion Management system as monitored elements pending the PUCT decision.

If ERCOT has not received acknowledgement that a request has been received within thirty (30) days of its sending, ERCOT will contact the TDSP or QSE for verification of receipt.

#### **8.1.6.2 Telemetry Requests for Redundancy**

ERCOT will maintain redundancy on measurements critical to transmission reliability of the ERCOT interconnection. ERCOT will identify and produce a list of telemetry points in the ERCOT system that is critical to the state estimator solution. This list will be published annually. ERCOT will use this list to identify telemetry points whose loss will result in:

- (1) Inability of ERCOT to monitor loading on a transmission line operated at 345 kV or above.
- (2) Inability of ERCOT to monitor loading on a 345/138 kV autotransformer.
- (3) Inability of ERCOT to monitor loading on transmission facilities designated as critical to transmission reliability by ERCOT. A list of critical facilities will be published annually.

Telemetry points identified as critical to the state estimator solution shall demonstrate a historical availability of at least eighty percent (80%) over any two (2) consecutive months in order to be considered an “available telemetry point”.

ERCOT may request additional MW, MVAR and voltage telemetry to make these measurements redundant. In this request, ERCOT will identify the critical points, and the contingency/overload condition and the unit dispatch which makes this a possible concern. If the request is for telemetry at multiple locations, ERCOT will prioritize the requested additions.

Upon receipt of a request for additional telemetry, a TDSP or QSE has sixty (60) days to:

- (1) Provide ERCOT with a schedule of equipment installations within the next eighteen (18) months which will provide the proposed telemetry;
- (2) Propose an alternative solution which will serve the same purpose as the ERCOT identified telemetry additions with a proposed implementation within 18 months;
- (3) In cases where the request is based on the availability rate of an existing telemetry point, the TDSP or QSE will provide a plan to improve the availability rate of the identified critical telemetry to an acceptable level, or provide documentation for why this cannot be accomplished;



- (4) Identify and propose a schedule of equipment installations within the next 18 months which would, as a result, make the transmission element identified by ERCOT non-critical; or
- (5) Indicate that the facility that telemetry is being requested is not owned or covered by an interconnect agreement that allows the requested party to install the additional telemetry.

If ERCOT does not have knowledge that a request has been received within thirty (30) days of its sending, ERCOT will contact the TDSP or QSE for verification of receipt.

### **8.1.7 TDSP/QSE Metering Restoration**

Operational Meter data shall be provided continuously. Lost data or signals, whether failed or in error, must be restored promptly by the provider of the Operational Metering data. It is recognized that some data may be more critical than other data. ERCOT will inform the TDSP or QSE if a data item is critical and needs to be repaired as quickly as possible. QSE and TDSP repair procedures and records shall be made available to ERCOT upon request.

### **8.1.8 QSE and TDSP Data Acquisition**

Suppliers of Operational Metering must collect and process field data at their control centers before passing to the ERCOT interface. The equipment and processes are owned and operated entirely by the supplier. Traditionally, utilities have used both analog and digital methods of transmission at existing facilities. It is the responsibility of the QSEs and TDSPs who supply other entities' data to ERCOT to also arrange for reliable delivery of field data from the other entities in order to support the requirements in this Operating Guides.

## **8.2 Calibration and Testing**

### **8.2.1 Responsibility**

It is the responsibility of the owner to insure that calibration, testing and other routine maintenance of equipment is done on a timely basis, and that accuracy meets or exceeds that which is specified in this Appendix, for both the overall system and for individual equipment where detailed herein. Coordination of outages required for these activities with ERCOT is also the responsibility of the owner.

### **8.2.2 Notification**

ERCOT and all affected parties shall be notified at least 72 hours in advance, or at a mutually acceptable advance notice, prior to any calibrations or planned maintenance. In emergency conditions, the owner of the operational metering and associated equipment may make necessary repairs with notification to affected parties within 24 hours. ERCOT or other parties sharing data from the equipment may request copies of the repair and calibration records.

**8.2.3 Test Equipment**

Test equipment and test standards intended to be used for the calibration of operational metering and associated equipment shall be certified to values of accuracy and precision that are equal to or better than the accuracy of the equipment under test.

**8.2.4 Disputes**

Where a dispute over the accuracy or performance of any operational metering equipment exists, ERCOT may request a comparison of standards and/or a joint calibration of affected equipment.

**8.2.5 Calibration Testing**

All operational metering and associated equipment for analog data quantities (MW, MVAR, Volts, LTC tap positions, etc.) shall be tested as needed to ensure accuracy and performance. Entities providing Operational Metering data to ERCOT shall make their test records, procedures and maintenance criteria available to ERCOT upon request.

**8.2.6 Exchange of Information****Reference: Protocols Section 8.8.1, Coordination with ERCOT**

*Prior to energizing and placing into service any new or relocated Facility connected to the ERCOT Transmission Grid, TSPs shall coordinate with and receive approval from ERCOT.*

**8.2.7 Documentation**

Information on existing ERCOT System components and topology is necessary for ERCOT to create databases and perform tests. To ensure that such information is made available to ERCOT, each TDSP, or its designated agent, shall provide accurate information for all ERCOT Transmission Facilities owned by the TDSP. The information provided shall include, but not be limited to, the following:

- (1) Information necessary to represent the TDSP's Transmission Facilities in the ERCOT Operations Model, including modeling information detailed in procedures of ERCOT and Network Data Support Working Group (NDSWG);
- (2) Identification of a designated contact person responsible for providing answers to questions ERCOT may have regarding the information provided; and
- (3) TDSP owned or operated Transmission Facility data provided and used to accurately represent a Transmission Facility in a model shall be consistent to the extent practicable with data provided and used to represent that same Transmission Facility in any other model created to represent a time period during which the Transmission Facility is expected to be physically identical. All existing transmission lines' and transformers' impedances (or equivalent branch circuit impedance) and ratings (normal and emergency) shall be identical, to the extent practicable. If all normally closed breakers and switches are closed and normally open breakers and switches are open in the network operations model, the calculated line flows between substations in the annual planning model shall be consistent (very close), when all models use the same Load magnitude and distribution, generation commitment and

Dispatch, and Voltage Profile. The TDSP shall provide an explanation to ERCOT for data inconsistencies.

**Reference: Protocols Section 8.8.2.1, TSP Information to be provided to ERCOT**

*The TSP shall notify ERCOT at least thirty (30) days before starting to energize or place into service any new or relocated Facility. The Notice shall be submitted in accordance with formats and procedures adopted by ERCOT and TSPs. For Notices involving co-owned, co-operated, or co-rated Transmission Facilities, the TSP submitting the initial Notice shall communicate with the other Market Participants responsible for co-owning, co-operating, or co-rating said Transmission Facilities prior to the Notice submittal. The Notice shall include the following information:*

- (1) *Proposed energize date;*
- (2) *TSP performing work;*
- (3) *TSP(s) responsible for rating affected transmission element(s);*
- (4) *Location Code if applicable (e.g. station code);*
- (5) *Identification of existing Transmission Facilities involved and new Transmission Facilities (if any) being added or existing Transmission Facilities being permanently removed from service;*
- (6) *Ratings of existing Transmission Facilities involved and new Transmission Facilities (if any) being added;*
- (7) *Outages required (clearly identify each Outage if multiple Outages are required), including sequence of Outage and estimate of Outage duration;*
- (8) *General statement of work to be completed with intermediate progress dates and events identified;*
- (9) *Supervisory Control and Data Acquisition modification work including descriptions of any new data telemetry points or changes to existing telemetry;*
- (10) *Additional data determined by ERCOT and TSP(s) as needed to complete the ERCOT model representation of existing Transmission Facilities involved and new Transmission Facilities (if any) being added;*
- (11) *Statement of completion, including:*
  - (a) *Statement to be made at the completion of each intermediate stage of project; and*
  - (b) *Statement to be made at completion of total project.*
- (12) *Drawings to be attached, including:*
  - (a) *Existing status;*
  - (b) *For each intermediate stage; and*

*(c) Proposed completion of job.*

The parties involved shall furnish pertinent information to ERCOT on request, including the following:

- Connection diagrams
- Metering one line diagram
- Substation one line diagram
- Panel schematics and one line diagrams
- Instrument transformer (CT and PT) data (ratios, test reports, nameplate)
- Transducer conversion constants
- Meter constants
- RTU and digital device configuration details
- Certified calibration test reports of any device used for operational metering
- Other data as may be requested

**8.2.8 Operator One-line Displays**

Operations staff at each entity providing Operational Metering data shall have one-line diagrams displayable on their Energy Management System or other computer systems. Displays shall be provided for all substations or power plant switchyards that include data passed to the ERCOT interface.

**8.2.9 Notification of Changes**

**Reference: Protocols Section 8.8.2.3, Changes to Work Approved by ERCOT.**

*The TSP shall notify ERCOT and any other affected TSPs as soon as practicable of any requested changes to the work plan. ERCOT shall review and approve or reject changes to the work in accordance with Section 8.8, Coordination for System Topology Modifications.*

ERCOT and any other affected parties shall be informed of changes to operational metering and associated equipment 30 days prior to placing in service. All parties must be notified so a mutually agreeable time can be set for the changes. All parties involved must be satisfied prior to the making of any changes.

### 8.3 Communications

There are two (2) types of data communication that will be implemented in the ERCOT System:

- Real Time Communications (Operational), and
- Commercial Market Communications (Settlement).

This Operating Guide defines the path standards for Real Time data communications (Operational) and voice communications (Operational) that shall be used to exchange security and reliability information between:

- ERCOT and a Qualified Scheduling Entity (QSE), and
- ERCOT and a Transmission and/or Distribution Service Provider (TDSP).

As Operational signals may originate with or be destined for organizations connected to a QSE or TDSP, path standards are also defined for Real Time data communications (Operational) and voice communications (Operational) required by QSEs and TDSPs that impact or contribute to security and reliability information required by ERCOT.

Commercial Market Communications (Settlement) are not defined in this Operating Guide, other than facilities needed to provide common communications. Operational Communication requirements take precedence over Commercial Market Communication requirements.

#### 8.3.1 ERCOT WAN

In order to facilitate wholesale operations and frequency control as a single control area, ERCOT provides a wide area network (the ERCOT WAN). This communications network uses redundant, digital communications between ERCOT control centers and one (1) or more facilities at each QSE and TDSP. The ERCOT WAN has sufficient bandwidth capacity and speed to enable:

- Real Time (operational metering) data exchange for frequency control and transmission security
- Operational voice communications for both normal and emergency use. The ERCOT WAN supports both off-premise exchanges (OPX) with ERCOT's control facilities and the ERCOT Hotlines.
- Data exchange to support applications programming interface routines. These include power scheduling, Operating Plans, Outage requests, Dispatch Instructions, posting of information and other applications.

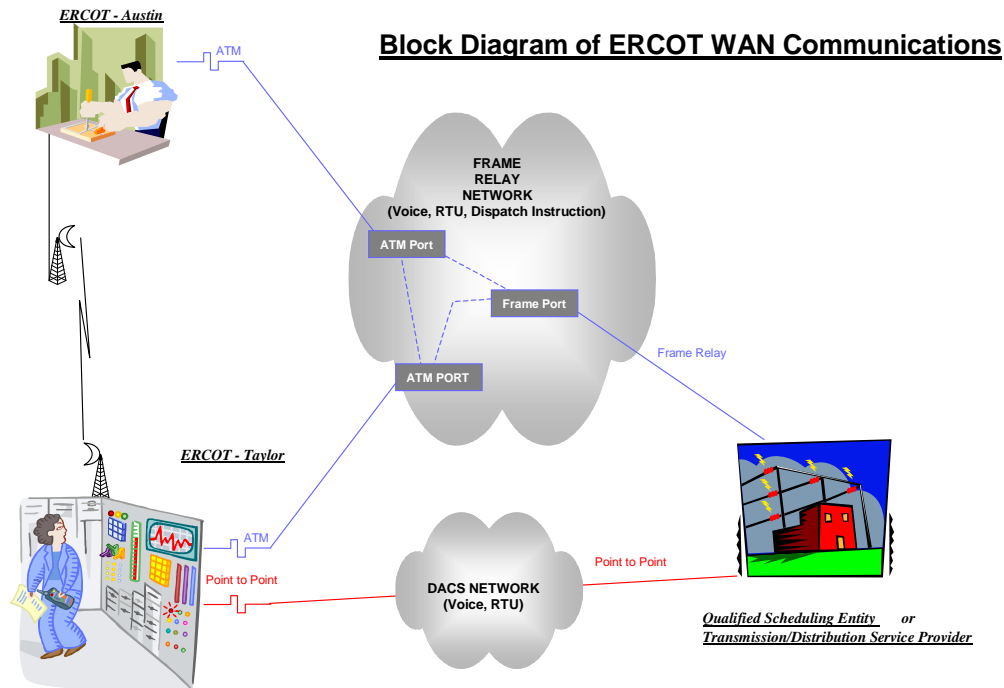

### 8.3.1.1 QSE Use of Domain Name Service (DNS) or ERCOT Web-Based Front Page for Site Failover

A QSE possessing backup sites must utilize one of the following two (2) options: (1) a WAN (Wide Area Network) Domain Name Service (DNS) server or (2) an ERCOT provided web-based DNS service to facilitate the failover process when moving its operations between primary and backup sites. The requirements of these options are specified below.

#### 8.3.1.1.1 DNS Server Configuration for Failover Support

A QSE is required to provide and maintain its own DNS servers that must be accessible by the ERCOT WAN. The failover process requires the following:

- (1) DNS servers must support zone transfers over TCP port 53.
- (2) Firewalls must allow zone transfers to ERCOT DNS servers.
- (3) Zone files for the QSE's domains (e.g. examplepower.com) must reside on its WAN accessible DNS servers.
- (4) DNS servers must be set up as the master for its zone.
- (5) DNS servers must allow ERCOT DNS servers to transfer the zone files (ERCOT will be set up as a secondary/slave server for the zone).

- (6) The zone files must contain names for all local servers the QSE will need ERCOT services to access. At a minimum, it must contain entries for the servers that can be switched over to the backup site. The zone file must also contain entries for the QSE's primary website address (e.g. www.examplepower.com) and other common internet accessible sites that ERCOT servers may have occasional need to access.
- (7) Time to Live (TTL) values for backup host entries in the zone file must be set to 0 in order to prevent the host to IP address mappings from being cached on the client machines. This allows any changes made to a zone file to take effect immediately upon a zone transfer.

Once its DNS servers are operational, the QSE shall timely contact its ERCOT Client Services Representative and request that an ERCOT network administrator work with the QSE to test the functionality of the DNS setup. The QSE must contact the ERCOT Client Services Representative at least five (5) Business Days before testing.

After the zone transfer testing is complete, the QSE shall supply its ERCOT Client Services Representative with a list of participant servers, their DNS names, and their roles on the network. The ERCOT Client Services Representative will then contact the application owners at ERCOT to change application communications to use the DNS name instead of IP addresses.

After successful completion of the test, when a QSE backup site failover is desired, the QSE shall update the zone file with its disaster recovery IP addresses and publish it to the ERCOT DNS servers. The change will be effective immediately. The QSE shall also implement a DNS server at its backup site. This allows updated zone files to be published regardless if the primary site is up or not.

#### **8.3.1.1.2 Web-Based DNS Access**

This access is provided as an alternative method for any QSE that does not wish to maintain its own DNS servers. Access is provided over the ERCOT WAN only. The QSE is responsible for access through its networks to the web servers located on the ERCOT WAN. The QSE shall adhere to ERCOT password requirements.

To failover to or from a backup site, the QSE shall update the IP address of the existing entry. ERCOT servers will accept the change and start using the new IP immediately.

Once the QSE has connectivity to the web server over the ERCOT WAN, it shall contact its ERCOT Client Services Representative and request that an ERCOT network administrator work with the QSE to test the functionality of the DNS setup. The QSE shall contact the ERCOT Client Services Representative at least five (5) Business Days before testing. After testing is completed, the Client Services Representative will contact the application owners at ERCOT to change application communications to use DNS names instead of IP addresses.

After successful completion of the test, when a QSE site failover is desired, the QSE shall change the Web page entries with the active site information and the change will be effective immediately.

### 8.3.2 ERCOT Responsibilities

ERCOT supplies interface requirements, equipment, installation and 24-hour maintenance for the entire ERCOT WAN, including equipment at each QSE and TDSP control facility, as well as ERCOT's control centers. ERCOT's responsibilities include:

- Supply and install fully configured and tested Customer Premises Equipment including routers, CSU/DSUs, LAN switch/hub and all support equipment for management purposes.
- Order and provision of local loop, network access point and transport.
- Design, configure, test, and install network monitoring and management service.
- Provide 24-hour network monitoring and management.
- Provide 24X7 maintenance, with 4-hour response, for all ERCOT equipment located at participant site.
- ERCOT will be the single point of contact for all network issues.

### 8.3.3 QSE and TDSP Responsibilities

TDSPs and QSEs whose facilities connect to the ERCOT WAN are required to sign an agreement with ERCOT governing installation, operation and maintenance. Users of the ERCOT WAN shall provide signal connections, uninterruptible power, and physical space for ERCOT-supplied WAN interface equipment at their control centers, as well as 24-hour access for ERCOT installation and maintenance personnel.

At these facilities, computer and communications equipment connected to ERCOT WAN interfaces is the complete responsibility of the QSE or TDSP. Facilities shall have uninterruptible power supplies (UPS) capable of independently supplying all equipment connected to the ERCOT WAN for at least 72 hours.

Any TDSP or QSE facility, whether primary or backup, involved in the transfer of the data sets identified in Attachment 8A, ERCOT Data Sets, will be required to connect directly to the ERCOT WAN Frame Relay and Point-to-Point paths. If a TDSP and QSE utilize the same EMS and server network at one location and do not have an equipped backup center, ERCOT will only connect to this one location for the transfer of data. If a TDSP and QSE share a centralized Private Branch Exchange (PBX), separate Off Premise Extension (OPX) circuits will be terminated for each participant.

Each Market Participant is required to extend the ERCOT OPX and Hotline voice circuits into its system operations desk that is staffed continuously. ERCOT will deliver the OPX and Hotline to a channel bank provided by the Market Participant. The OPX and Hotline voice circuits are transported on separate Digital Signal Level 0 (DS0) channels. In the event a Market Participant represents other Entities through an agency agreement approved by ERCOT, each Entity represented must have dedicated OPX circuits. In these cases, a single Hotline button will be used for the Market Participant and all of the represented Entities. It is the Market Participant's responsibility to deliver the Hotline and the OPX to the Market Participant's system operations desk in a manner that reasonably assures continuous communication with ERCOT and is not



affected by PBX features such as automatic transfer or roll to voice mail. The demarcation point for all voice circuits is the Market Participant's channel bank.

A QSE or TDSP involved in the transfer of the critical data identified in Attachment 8A will be required to provide the following communication resources to support the connection to the ERCOT private network:

- Private Network
  - Provide an analog business phone line or PBX analog extension for trouble shooting and maintenance of equipment.
  - Provide a height of 24" of rack space in a 19" wide rack.
  - Provide two separate UPS single-phase 115 VAC 20 amp circuits, each with 4 receptacles in the 19" rack listed above.
  - Provide building wiring from circuit termination to equipment rack.
  - Within 24-hours notice, provide ERCOT employees or contractors access to the communication facility.
  - Within 1-hour notice, provide emergency access to the facility to ERCOT employees or contractors.
  - Provide on site personnel to escort ERCOT employees or contractors.
  - Provide a Firewall or router, located at the Market Participant site, for the network address translation of internal Market Participant addresses to external addresses on the ERCOT Local Area Network (LAN).
  - Market Participant will be required to sign a security connection agreement with ERCOT.
  - Provide connectivity from Market Participant Firewall or Router to ERCOT LAN located at Market Participant site. Market Participants are responsible for their own security through this connection.
  - Provide a channel bank with at least one T1 interface, 4 Foreign Exchange Station (FXS) and two 4 wire analog ports. Connect FXS (e.g. PBX, key system) and 4 wire ports to the appropriate equipment (e.g. Remote Terminal Unit (RTU)). On the digital T1 stream, levels for voice are zero dpm for transmit and receive and levels for RTU are -13 dpm for transmit and receive.
  - Dual cable entrances to Market Participant, connecting to different Telco Central Offices highly recommended.
  - Provide ERCOT with internal IP addressing scheme as needed for network design. This will be kept confidential.
- Internet (optional)

A QSE or TDSP not involved in the transfer of the data identified in Attachment 8A is not required to, but, may request ERCOT to provide an optional connection to the ERCOT private network. When such a request is met by ERCOT, the QSE or TDSP must then provide the above stated communications resources.

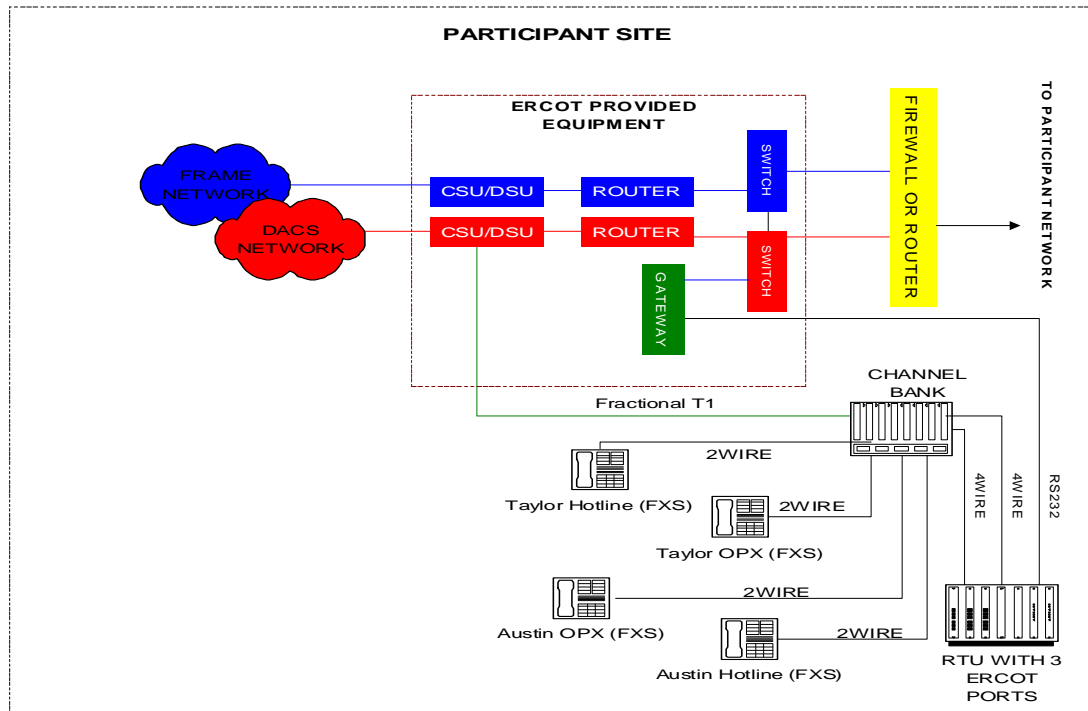

### 8.3.4 TDSP and QSE Supplied Communications

Each TDSP and QSE must provide internal facilities and communications to collect and furnish data and voice signals to the ERCOT WAN. For TDSPs these include, but may not be limited to, voice communications and SCADA for substations and other transmission facilities. For QSEs, these include, but may not be limited to, voice and SCADA for generating plants and loads.

QSEs and TDSPs shall supply, implement and maintain all data and voice communication facilities required to fulfill the obligations set forth in the Operating Guides.

Proper performance, maintenance and testing of communication paths not directly connected to the ERCOT WAN shall be the responsibility of the TDSP or QSE providing the path.

QSEs communicating with connected resources and TDSPs communicating with substations are encouraged to use privately owned communication facilities. Backup facilities utilizing common carriers, different privately owned facilities, or communications paths to a site are encouraged to provide increased reliability (i.e., separate paths to a site using different carrier, having multiple microwave paths leaving a site, etc.).

### 8.3.5 Maintenance and Restoration

It is the joint responsibility of ERCOT WAN-connected parties to coordinate maintenance and restoration activities so its reliability is not compromised. Coordination and notification procedures defined by ERCOT are to be followed by all parties.

All circuits shall be tested annually or as otherwise requested by ERCOT for end-to-end performance. Special attention shall be given to circuits not used for routine communications (including backup circuits).

The Hotline and any backup (alternate path) voice circuits shall be used regularly to insure proper performance. ERCOT will specify test procedures for Hotline circuits.

Scheduled outages of communication circuits that could reduce the reliability of interconnected operations shall be coordinated between the affected companies and ERCOT.

In the event of wide spread communication failures, priority shall be given to restoring communication circuits between QSE Control Centers/TDSP Control Centers and ERCOT Control Area Authority first, and between QSEs and TDSPs second.

Test equipment and test standards intended to be used for the calibration or repair of communication equipment shall be certified to values of accuracy and precision, which are equal to or better than the accuracy of the equipment under test.

## 8.4 Document Control

### *Authorities*

Prepared by	Date Completed	Reviewed by	Date Authorized
B. Brodie	December 29, 2000	B. Garza, Chair – Joint Operating Guide Working Group	
I. Flores	December 1, 2002	OGRTF & ROS	November, 2002
I. Flores	March 1, 2003	OGRTF	

### *Distribution List*

Name	Organization
Operating Guide Working Group	ERCOT
Operations	ERCOT
Technical Advisory Committee	ERCOT
Reliability Operations Subcommittee	Technical Advisory Committee
Operating Guides Revision Task Force	Reliability Operations Subcommittee

### *Change History*

Issue/Draft	Reason for issue	Date
Version 0.1	Draft for Review	December 29, 2000
Version 0.2	2 <sup>nd</sup> Draft for Review	January 18, 2001
Version 0.3	Stakeholder Review	January 19, 2001
Version 0.4	Stakeholder Review	February 5, 2001
Version 1.0	Updated from Working Group comments. Submitted to Technical Advisory Committee to approve handover to the Reliability Operating Subcommittee	February 28, 2001
December 1, 2002	OGRR117; added language from “Communicating with ERCOT” and Protocols references.	December 1, 2002
March 1, 2003	Revised header.	March 1, 2003
December 1, 2004	Admin OGRR160	December 1, 2004
September 1, 2005	OGRR163	September 1, 2005
February 1, 2006	OGRR180	February 1, 2006
June 1, 2006	OGRR176	June 1, 2006
October 1, 2006	OGRR181	October 1, 2006
July 1, 2007	OGRR201	July 1, 2007

<b>Issue/Draft</b>	<b>Reason for issue</b>	<b>Date</b>
March 1, 2008	OGRR204	March 1, 2008
May 1, 2008	Admin OGRR207	May 1, 2008
January 1, 2009	OGRR214	January 1, 2009
April 1, 2009	OGRR221	April 1, 2009
June 8, 2009	OGRR222	June 8, 2009

**Attachment 8A: ERCOT Data Sets**

For any required data, the following table describes how the data is to be provided to ERCOT.

ACTION	DATA QUANTITY	PURPOSE	SUPPLIED BY	RECEIVED BY	FREQUENCY	MODE OF COMM.	FORMAT	PROTOCOLS REFERENCE / COMMENTS
<b>DAY-AHEAD SCHEDULING PROCESS</b>								
Extend Day-Ahead Scheduling Process	Notification to extend Day-Ahead Scheduling Process to Two-Days-Ahead	Emergency Notification	ERCOT	QSE	Demand	API	XML	Protocol Section 4.4.19, Decision to Extend Day-Ahead Scheduling Process to Two-Day-Ahead Scheduling Process
Day Ahead Notification	Transmission Outages	Day-Ahead Planning	ERCOT	QSE	Daily before 0600	API	XML	Protocol Section 4.4.2, Posting of Forecasted ERCOT System Conditions
	Total Transmission Capacity	Day-Ahead Planning	ERCOT	QSE	Daily before 0600	API	XML	Protocol Section 4.4.2, Posting of Forecasted ERCOT System Conditions
	Weather assumptions used by ERCOT to forecast system conditions	Day-Ahead Planning	ERCOT	QSE	Daily before 0600	API	XML	Protocol Section 4.4.2, Posting of Forecasted ERCOT System Conditions
Day-Ahead Notification	Ancillary Services (AS) Plan	Day-Ahead Planning	ERCOT	QSE	Daily before 0600	API	XML	Protocol Section 4.4.3, Notification to the Market of ERCOT's Day Ahead Ancillary Services Plan
	Ancillary Service Obligations	Day-Ahead Planning	ERCOT	QSE	Daily by 0600	API	XML	Protocol Section 4.4.4, Notification to QSEs of Ancillary Service Obligations
	Mandatory Balancing Energy Service Down Bid Percentage requirements	Day-Ahead Planning	ERCOT	QSE	Daily by 0600	API	XML	Protocol Section 4.4.5, Notification to QSEs of Mandatory Balancing Energy Service Down Bid Percentage Requirements
	Transmission and Distribution Loss Estimates	Day-Ahead Planning	ERCOT	QSE	Daily by 0600	API	XML	Protocol Section 4.4.6, Notification to QSEs of Transmission Loss Factors and Distribution Loss Factors
	Update of Forecasted System Conditions (total forecast system load and load forecasts in each congestion Zone)	Day-Ahead Planning	ERCOT	QSE	Daily @ 0600	API	XML	Protocol Section 4.4.7, Update of Forecasted ERCOT System Conditions

## SECTION 8: OPERATIONAL METERING AND COMMUNICATION

ACTION	DATA QUANTITY	PURPOSE	SUPPLIED BY	RECEIVED BY	FREQUENCY	MODE OF COMM.	FORMAT	PROTOCOLS REFERENCE / COMMENTS
QSEs Submit Balanced Schedules of Obligations and Supply	Balanced Schedules	CSC Congestion and Capacity Insufficiency	QSE	ERCOT	Daily before 1100, @ 1300, then as needed	API	XML	Protocol Section 4.4.8, Submittal of Day-Ahead Schedules and Ancillary Services Schedules, & Protocol Section 4.4.10, Submittal of Updated Balanced Energy Schedules.
Self-Arranged Ancillary Services	Self Provided Regulation Up	AS (Rolled up from REP to QSE)	QSE	ERCOT	Daily before 1100, @ 1300, then as needed	API	XML	Protocol Section 4.4.8, Submittal of Day-Ahead Schedules and Ancillary Services Schedules, & Protocol Section 4.4.10, Submittal of Updated Balanced Energy Schedules.
	Self Provided Regulation Down	AS (Rolled up from REP to QSE)	QSE	ERCOT	Daily before 1100, @ 1300, then as needed	API	XML	Protocol Section 4.4.8, Submittal of Day-Ahead Schedules and Ancillary Services Schedules, & Protocol Section 4.4.10, Submittal of Updated Balanced Energy Schedules.
	Self Provided Responsive Reserve	AS (By Portfolio)	QSE	ERCOT	Daily before 1100, @ 1300, then as needed	API	XML	Protocol Section 4.4.8, Submittal of Day-Ahead Schedules and Ancillary Services Schedules, & Protocol Section 4.4.10, Submittal of Updated Balanced Energy Schedules.
	Self Provided Non-Spinning Reserve	AS (By Portfolio, By Zone)	QSE	ERCOT	Daily before 1100, @ 1300, then as needed	API	XML	Protocol Section 4.4.8, Submittal of Day-Ahead Schedules and Ancillary Services Schedules, & Protocol Section 4.4.10, Submittal of Updated Balanced Energy Schedules.
Validate Schedules and Bids	Notification of invalid or mismatched schedules	Validate Schedules	ERCOT	QSE	Daily @ 1100 & 1300	API	XML	Protocol Section 4.4.12, ERCOT Validation of QSE Day-Ahead Schedules and Bids
	Corrected Schedules	Submit corrected information	QSE	ERCOT	Daily @ 1115 & 1315	API	XML	Protocol Section 4.4.12, ERCOT Validation of QSE Day-Ahead Schedules and Bids
	Notification of CSC Congestion and/or Capacity Insufficiency	Update Schedules	ERCOT	QSE	Daily by 1115	API	XML	Protocol Section 4.4.9, ERCOT Notification of CSC Congestion and/or Capacity Insufficiency Based on 1100 Balanced Schedules
Procure Ancillary Services	AS Bids to ERCOT	Ancillary Services Market	QSE	ERCOT	Daily by 1300	API	XML	Protocol Section 4.4.11, Ancillary Services Bid Submittal
	Purchase Regulation Up	Complete Day-Ahead Ancillary Services Plan	ERCOT	QSE	Daily by 1330	API	XML	Protocol Section 4.4.13, ERCOT Day Ahead Ancillary Services Procurement Process

SECTION 8: OPERATIONAL METERING AND COMMUNICATION

ACTION	DATA QUANTITY	PURPOSE	SUPPLIED BY	RECEIVED BY	FREQUENCY	MODE OF COMM.	FORMAT	PROTOCOLS REFERENCE / COMMENTS
	Purchase Regulation Down	Complete Day-Ahead Ancillary Services Plan	ERCOT	QSE	Daily by 1330	API	XML	Protocol Section 4.4.13, ERCOT Day Ahead Ancillary Services Procurement Process
	Purchase Responsive Reserves	Complete Day-Ahead Ancillary Services Plan	ERCOT	QSE	Daily by 1330	API	XML	Protocol Section 4.4.13, ERCOT Day Ahead Ancillary Services Procurement Process
	Purchase Non-Spinning Reserves	Complete Day-Ahead Ancillary Services Plan	ERCOT	QSE	Daily by 1330	API	XML	Protocol Section 4.4.13, ERCOT Day Ahead Ancillary Services Procurement Process
	Ancillary Services Schedules	Notification of Selected Ancillary Services Bids	ERCOT	QSE	Daily by 1330	API	XML	Protocol Section 4.4.14, ERCOT Notification of Selected Ancillary Services Bids
	Publish Day-Ahead MCPs for Capacity (MCPCs) for each Day-Ahead Ancillary Service	Complete ERCOT's Day-Ahead Ancillary Services Plan	ERCOT	QSE	Daily @ 1330	API	XML	Protocol Section 4.4.13, ERCOT Day Ahead Ancillary Services Procurement Process
	Final Ancillary Services Schedules	Updated Day Ahead Ancillary Services Schedule	QSE	ERCOT	Daily @ 1500	API	XML	Protocol Section 4.4.14, ERCOT Notification of Selected Ancillary Services Bids
QSE Present Resource Plan	Unit Availability Status	Generation Planning, AS Verification	QSE	ERCOT	Daily @ 1600, then as needed	API	XML	Protocol Section 4.4.15, QSE Resource Plans
	Unit Planned Net Hourly Generation MW	Generation Planning, AS Verification	QSE	ERCOT	Daily @ 1600, then as needed	API	XML	Protocol Section 4.4.15, QSE Resource Plans
	Unit Planned High Net Hourly Operating Limit MW	Generation Planning, AS Verification	QSE	ERCOT	Daily @ 1600, then as needed	API	XML	Protocol Section 4.4.15, QSE Resource Plans
	Unit Planned Low Net Hourly Operating Limit MW	Generation Planning, AS Verification	QSE	ERCOT	Daily @ 1600, then as needed	API	XML	Protocol Section 4.4.15, QSE Resource Plans
	Load acting as a Resource	Generation Planning, AS Verification	QSE	ERCOT	Daily @ 1600, then as needed	API	XML	Protocol Section 4.4.15, QSE Resource Plans
	Notification to QSE for insufficient resources	Generation Planning, AS Verification	ERCOT	QSE	Daily by 1600	API	XML	Protocol Section 4.1.15, QSE Resource Plans
Procure Replacement Reserve Service	Unit-Specific Replacement Reserve Service (RPRS) Bids	QSEs may submit Replacement Reserve Service (RPRS) Bids	QSE	ERCOT	Daily by 1600, then as needed	API	XML	Protocol Section 4.4.16, ERCOT Receipt of Replacement Reserve Service Bids



SECTION 8: OPERATIONAL METERING AND COMMUNICATION

ACTION	DATA QUANTITY	PURPOSE	SUPPLIED BY	RECEIVED BY	FREQUENCY	MODE OF COMM.	FORMAT	PROTOCOLS REFERENCE / COMMENTS
	Resource Specific Premiums	QSEs may submit hourly Resource specific premiums	QSE	ERCOT	Daily by 1430, then as needed	API	XML	Protocol Section 4.5.3, ERCOT Receipt of Resource Specific Premiums for Operational Congestion Management
	Procurement of Replacement Reserve	ERCOT purchase RPRS	ERCOT	QSE	Daily by 1800	API	XML	Protocol Section 4.4.17, ERCOT Procurement of Replacement Reserve Service As Needed
	Adjustments to schedules of Reliability Must-Run (RMR) resources	Adjustments to the QSE's schedules	ERCOT	QSE	Demand	API	XML	Protocol Section 4.5.11, Scheduling Requirements for RMR Units and Black Start Resources
<b>ADJUSTMENT PERIOD</b>								
		QSE's can make schedule adjustments and ERCOT can request additional bids.			Time T is the start of the Operating Period			The Adjustment Period (AP) begins following the close of the Day-Ahead market and continues until one (1) hour prior to the beginning of the Operating Hour.
Adjustment Period Schedule Changes	Submit or change Energy Schedule and Ancillary Services Schedules	Adjustment Period Scheduling Process	QSE	ERCOT	T minus 60 minutes	API	XML	Protocol Section 4.5.1, Receipt of Adjustment Period Schedule Changes
	Submit, change, or remove Balancing Energy Service Up and Down Bids	Adjustment Period Scheduling Process	QSE	ERCOT	T minus 60 minutes	API	XML	Protocol Section 4.5.1, Receipt of Adjustment Period Schedule Changes
	Submit, change, or remove RPRS Bids	Adjustment Period Scheduling Process	QSE	ERCOT	T minus 60 minutes	API	XML	Protocol Section 4.5.1, Receipt of Adjustment Period Schedule Changes
	Require mandatory Balancing Energy Service Down Bid Curves	Adjustment Period Scheduling Process	ERCOT	QSE	T minus 60 minutes	API	XML	Protocol Section 4.5.2, Receipt of QSE's Balancing Energy Bid Curves
	Submit Balancing Energy Service Up and Down Bid Curves	Adjustment Period Scheduling Process	QSE	ERCOT	T minus 60 minutes	API	XML	Protocol Section 4.5.2, Receipt of QSE's Balancing Energy Bid Curves
	Announce need to procure RPRS	Procure Submitted Bids	ERCOT	QSE	T minus 60 minutes	API	XML	Protocol Section 4.5.6, ERCOT Notice of Need to Procure Replacement Reserve Service Resources
	Announce need to procure additional Ancillary Services	Procure Submitted Bids	ERCOT	QSE	T minus 60 minutes	API	XML	Protocol Section 4.5.8, ERCOT Notice of Need to Procure Additional Ancillary Services
	QSE Update their Resource Plan	Update prior to close of the Adjustment Period	QSE	ERCOT	T minus 60 minutes	API	XML	Protocol Section 4.5.10, Updated Resource Plans

SECTION 8: OPERATIONAL METERING AND COMMUNICATION

ACTION	DATA QUANTITY	PURPOSE	SUPPLIED BY	RECEIVED BY	FREQUENCY	MODE OF COMM.	FORMAT	PROTOCOLS REFERENCE / COMMENTS
	QSE Update their Balanced Schedules	Adjustment Period Scheduling Process	QSE	ERCOT	T	API	XML	Protocol Section 4.5.6, ERCOT Notice of Need to Procure Replacement Reserve Service Resources & Protocol Section 4.5.8, ERCOT Notice of Need to Procure Additional Ancillary Services
	QSE Resubmit Corrected Balanced Schedule	Adjustment Period Scheduling Process	QSE	ERCOT	T plus 15 minutes	API	XML	Protocol Section 4.5.6, ERCOT Notice of Need to Procure Replacement Reserve Service Resources & Protocol Section 4.5.8, ERCOT Notice of Need to Procure Additional Ancillary Services
	Procure RPRS	ERCOT purchase RPRS	ERCOT	QSE	T plus 30 minutes	API	XML	Protocol Section 4.5.6, ERCOT Notice of Need to Procure Replacement Reserve Service Resources
	Procure additional Ancillary Services	ERCOT purchase additional ancillary service	ERCOT	QSE	T plus 30 minutes	API	XML	Protocol Section 4.5.8, ERCOT Notice of Need to Procure Additional Ancillary Services
<b>OPERATING PERIOD</b>								
								DNP 3.0 protocol will be used for new ports to RTUs or SCADA systems.
FCS Inputs	Frequency	Real-Time Monitoring and Control	ERCOT/QSE	ERCOT	2 sec	RTU/ICCP	DNP 3.0	Protocol Section 6.10.5, QSE Real Power Performance Criteria
Unit Monitoring	Generating Unit MW	Real-Time Monitoring & Security Analysis	QSE	ERCOT	2 sec	RTU/ICCP	DNP 3.0	Protocol Section 6.5.1.1, Requirement for Operating Period Data for System Reliability and Ancillary Service Provision Net Generation is preferred. If gross MW is supplied, aux load should also be provided.
	Generating Unit Mvar	Real-Time Monitoring & Security Analysis	QSE	ERCOT	10 sec	RTU/ICCP	DNP 3.0	Protocol Section 6.5.1.1, Requirement for Operating Period Data for System Reliability and Ancillary Service Provision Net Generation is preferred. If gross MVar is supplied, aux load should also be provided.
	Private Network Net Interchange to ERCOT	Real-Time Monitoring & Security Analysis	QSE	ERCOT	2 Sec	RTU/ICCP	DNP 3.0	For private networks, the net interchange shall be provided along with gross MW and MVar per generating unit.
	Private Network Net Interchange High Limit	Real-Time Monitoring & Security Analysis	QSE	ERCOT	10 sec	RTU/ICCP	DNP 3.0	For private networks, the high operating limit will reflect the maximum generation available at the point of interconnection to ERCOT.

SECTION 8: OPERATIONAL METERING AND COMMUNICATION

ACTION	DATA QUANTITY	PURPOSE	SUPPLIED BY	RECEIVED BY	FREQUENCY	MODE OF COMM.	FORMAT	PROTOCOLS REFERENCE / COMMENTS
	Private Network Net Interchange Low Limit	Real-Time Monitoring & Security Analysis	QSE	ERCOT	10 sec	RTU/ICCP	DNP 3.0	For private networks, the low operating limit will reflect the minimum generation available at the point of interconnection to ERCOT.
	Status of switching devices in the plant switchyard not monitored by the TDSP affecting flows on the ERCOT System	Real-Time Monitoring & Security Analysis	QSE	ERCOT	10 sec	RTU/ICCP	DNP 3.0	Protocol Section 6.5.1.1, Requirement for Operating Period Data for System Reliability and Ancillary Service Provision
	Generating Unit Breaker Status	Real-Time Monitoring & Security Analysis	QSE	ERCOT	10 sec	RTU/ICCP	DNP 3.0	Protocol Section 6.5.1.1, Requirement for Operating Period Data for System Reliability and Ancillary Service Provision
	Generating Unit High Operating Limit	Real-Time Monitoring & Security Analysis	QSE	ERCOT	10 sec	RTU/ICCP	DNP 3.0	Protocol Section 6.5.1.1, Requirement for Operating Period Data for System Reliability and Ancillary Service Provision
	Generating Unit Low Operating Limit	Real-Time Monitoring & Security Analysis	QSE	ERCOT	10 sec	RTU/ICCP	DNP 3.0	Protocol Section 6.5.1.1, Requirement for Operating Period Data for System Reliability and Ancillary Service Provision
NOTE: Operating Period data from QSE units can be made available to the PGCs host TDSP on request.								
	Load used as a Resource MW	Real-Time Monitoring	QSE	ERCOT	2 sec	RTU/ICCP	DNP 3.0	Protocol Section 6.5.1.1, Requirement for Operating Period Data for System Reliability and Ancillary Service Provision
	Load Resource Breaker Status	Real-Time Monitoring	QSE	ERCOT	10 sec	RTU/ICCP	DNP 3.0	Protocol Section 6.5.1.1, Requirement for Operating Period Data for System Reliability and Ancillary Service Provision
	Load Resource (providing Responsive Reserve) High-Set Underfrequency Relay Status	Real-Time Monitoring	QSE	ERCOT	10 sec	RTU/ICCP	DNP 3.0	Protocol Section 6.5.1.1, Requirement for Operating Period Data for System Reliability and Ancillary Service Provision
	QSE Frequency Bias	Real-Time Monitoring	QSE	ERCOT	2 sec	RTU/ICCP	DNP 3.0	Protocols Section 6.5.1.1, Requirement for Operating Period Data for System Reliability and Ancillary Service Provision
	Dynamic Resource Power Schedules	Real-Time Monitoring	QSE	ERCOT	2 sec	RTU/ICCP	DNP 3.0	Protocol Section 4.9, Dynamic Schedules, & Protocol Section 6.10.4.4, Schedule Control Error
	SCE	Real-Time Monitoring and Control (control only for regulation providers)	QSE	ERCOT	2 sec	RTU/ICCP	DNP 3.0	Feedback for QSE regulation calculation. Protocol Section 6.10.5, QSE Real Power Performance Criteria

SECTION 8: OPERATIONAL METERING AND COMMUNICATION

ACTION	DATA QUANTITY	PURPOSE	SUPPLIED BY	RECEIVED BY	FREQUENCY	MODE OF COMM.	FORMAT	PROTOCOLS REFERENCE / COMMENTS
	Regulation Feedback (loop-back)	Real-Time Monitoring	QSE	ERCOT	2 sec	RTU/ICCP	DNP 3.0	Protocol Section 6.5.1.1, Requirement for Operating Period Data for System Reliability and Ancillary Service Provision, & Protocol Section 6.7.2(8), Deployment of Regulation Service - Feedback the amount of RGS power (MW) being provided each control cycle
	Responsive Reserve Availability MW	Real-Time Monitoring	QSE	ERCOT	10 sec	RTU/ICCP	DNP 3.0	Feedback to Responsive Reserve Deployment. Protocols Section 6.7.3 (6), Deployment of Responsive Reserve Service
	Responsive Reserve Deployment MW	Real-Time Monitoring	QSE	ERCOT	10 sec	RTU/ICCP	DNP 3.0	Feedback to Responsive Reserve Deployment. Protocols Section 6.7.3 (6), Deployment of Responsive Reserve Service
	Non-Spinning Reserve Availability MW	Real-Time Monitoring	QSE	ERCOT	10 sec	RTU/ICCP	DNP 3.0	Feedback to Non-Spinning Reserve Deployment. Protocols Section 6.7.4 (7), Deployment of Non-Spinning Reserve Service
	Non-Spinning Reserve Deployment MW	Real-Time Monitoring	QSE	ERCOT	10 sec	RTU/ICCP	DNP 3.0	Feedback to Non-Spinning Reserve Deployment. Protocols Section 6.7.4 (7), Deployment of Non-Spinning Reserve Service
Deploy Ancillary Services	Instructed Regulation Up / Down MW	FCS Instruction	ERCOT	QSE	4 sec	RTU/ICCP	DNP 3.0	Protocol Section 6.5.1.1, Requirement for Operating Period Data for System Reliability and Ancillary Service Provision, & Protocol Section 6.7.2(1), Deployment of Regulation Service
	Instructed Responsive Reserve MW	FCS Instruction	ERCOT	QSE	4 sec	RTU/ICCP	DNP 3.0	Protocol Section 6.5.1.1, Requirement for Operating Period Data for System Reliability and Ancillary Service Provision, & Protocol Section 6.7.3(1), Deployment of Responsive Reserve Service
	SCE	Performance Monitoring	ERCOT	QSE	10 sec	RTU/ICCP	DNP 3.0	SCE Comparison for real-time monitoring and analysis by the ERCOT and QSE. Protocol Section 6.10.4.4, Schedule Control Error
	Governor Response	Monitoring	ERCOT	QSE	10 sec	RTU/ICCP	DNP 3.0	ERCOT calculated governor response from QSE frequency bias. Protocol Section 6.10.4.4, Schedule Control Error
	Generating Unit Governor Response	Real-Time Monitoring	ERCOT	QSE	10 sec.	RTU/ICCP	DNP 3.0	Protocol Section 6.5.1.1 Requirements for Operating Period Data for System Reliability and Ancillary Service Provision.
FCS Control Instructions	Instructed Non-Spinning Reserve MW	Instruction	ERCOT	QSE	Every 15 minutes	API	XML	Protocol Section 6.7.4(6), Deployment of Non-Spinning Reserve Service

SECTION 8: OPERATIONAL METERING AND COMMUNICATION

ACTION	DATA QUANTITY	PURPOSE	SUPPLIED BY	RECEIVED BY	FREQUENCY	MODE OF COMM.	FORMAT	PROTOCOLS REFERENCE / COMMENTS
	Instructed Balancing Energy MW (Up / Down)	Instruction	ERCOT	QSE	Every 15 minutes with 10 minutes notice	API	XML	Protocol Section 6.5.2, Balancing Energy Service, & Protocol Section 6.7.1.1(8), Creation of the Balancing Energy Bid Stack.
	Unit Automatic Voltage Regulator Status	Real Time Monitoring	QSE	ERCOT	10 sec	RTU/ICCP	DNP 3.0	
	Unit High Side Bus Voltage kV	Real-Time Monitoring	QSE	ERCOT	10 sec	RTU/ICCP	DNP 3.0	Protocol Section 6.5.7, Voltage Support Service, May be supplied by the TDSP. Low Side with appropriate transformer model may be substituted.
	Bus Voltage at Private Network connection to ERCOT	Real-Time Monitoring	QSE	ERCOT	10 sec	RTU/ICCP	DNP 3.0	This voltage may be supplied by the TDSP.
Reliability Instructions	Instructed Replacement Reserve	Instruction	ERCOT	QSE	As needed	API	XML	Protocol Section 6.5.6, Replacement Reserve Service
	Instructed Voltage Support	Instruction	ERCOT	QSE	As needed	API	XML	Protocol Section 6.5.7, Voltage Support Service
	Instructed Black Start	Instruction	ERCOT	QSE	As needed	API	XML	Protocol Section 6.5.8, Black Start Service
	Instructed Reliability Must-Run	Instruction	ERCOT	QSE	As needed	API	XML	Protocols Section 6.5.9, Reliability Must-Run Service
	Instructed Out-of-Merit Capacity	Instruction	ERCOT	QSE	As needed	API	XML	Protocol Section 6.5.10, Out-of-Merit Capacity and Out-of-Merit Energy Services
	Instructed Out-of-Merit Energy	Instruction	ERCOT	QSE	As needed	API	XML	Protocol Section 6.5.10, Out-of-Merit Capacity and Out-of-Merit Energy Services
<b>Security Analysis</b>								
Generation								Generating data is provided by QSEs as defined above under Operating Period Data
Bus								
	Bus Voltage kV	Real-Time Monitoring	TDSP	ERCOT	10 sec	ICCP	Blocks 1&2	
	Bus Frequency Hz	Real-Time Monitoring	TDSP	ERCOT	10 sec	ICCP	Blocks 1&2	
Transformer								
	Transformer Flow MW	Real-Time Monitoring	TDSP	ERCOT	10 sec	ICCP	Blocks 1&2	Positive flow is into the transformer
	Transformer Flow Mvar	Real-Time Monitoring	TDSP	ERCOT	10 sec	ICCP	Blocks 1&2	Positive flow is into the transformer
	LTC Tap Position	Real-Time Monitoring	TDSP	ERCOT	10 sec	ICCP	Blocks 1&2	

SECTION 8: OPERATIONAL METERING AND COMMUNICATION

ACTION	DATA QUANTITY	PURPOSE	SUPPLIED BY	RECEIVED BY	FREQUENCY	MODE OF COMM.	FORMAT	PROTOCOLS REFERENCE / COMMENTS
	Transformer Status	Real-Time Monitoring	TDSP	ERCOT	10 sec	ICCP	Blocks 1&2	Used if the computer(s) have a Network Topology Processor
Line								Circuit Breaker data may be used instead of line data.
	Line Flow MW	Real-Time Monitoring	TDSP	ERCOT	10 sec	ICCP	Blocks 1&2	Positive flow is out of the station
	Line Flow Mvar	Real-Time Monitoring	TDSP	ERCOT	10 sec	ICCP	Blocks 1&2	Positive flow is out of the station
	Circuit Status	Real-Time Monitoring	TDSP	ERCOT	10 sec	ICCP	Blocks 1&2	Used if the computer(s) have a Network Topology Processor
Shunt								
	Reactive Support from Shunt Mvar	Real-Time Monitoring	TDSP	ERCOT	10 sec	ICCP	Blocks 1&2	Positive for supplying VAR Negative for absorbing VAR
	Bank Status	Real-Time Monitoring	TDSP	ERCOT	10 sec	ICCP	Blocks 1&2	Used if the computer(s) have a Network Topology Processor
Circuit Breaker								Includes: Circuit Breaker (CB), Line Switch (LS), and Disconnect Switch (DCS) (where applicable) Line data may be used instead of circuit breaker data.
	CB MW flow	Real-Time Monitoring	TDSP	ERCOT	10 sec	ICCP	Blocks 1&2	Positive flow is from bus section to equipment (optional)
	CB Mvar	Real-Time Monitoring	TDSP	ERCOT	10 sec	ICCP	Blocks 1&2	Positive flow is from bus section to equipment (optional)
	Switch Position	Real-Time Monitoring	TDSP	ERCOT	10 sec	ICCP	Blocks 1&2	
Load								Load metering is preferred from the high side of the transformation point of the substation distribution transformer.
	Load in MW	Real-Time Monitoring	TDSP	ERCOT	10 sec	ICCP	Blocks 1&2	Negative for Load MW
	Load in Mvar	Real-Time Monitoring	TDSP	ERCOT	10 sec	ICCP	Blocks 1&2	Negative for Load Mvar
DC Injection								
	DC Injection in MW	Real-Time Monitoring	TDSP	ERCOT	10 sec	ICCP	Blocks 1&2	Positive flow is out of the station
	DC Injection in Mvar	Real-Time Monitoring	TDSP	ERCOT	10 sec	ICCP	Blocks 1&2	Positive flow is out of the station
	DC Tie Status	Real-Time Monitoring	TDSP	ERCOT	10 sec	ICCP	Blocks 1&2	Used if the Computer(s) have a Network Topology Processor
Weather Zone Tie Lines	Line Flow MW	Real-Time Monitoring	TDSP	ERCOT	10 sec	ICCP DNP 3.0	Blocks 1&2	TDSP's responsible for supplying weather zone tie line data must provide a redundant path from their normal ICCP link. This second path may be a second ICCP association to ERCOT or an RTU or other device using DNP 3.0 protocol.

NOTE: Real-Time data for Security Analysis can be provided to TDSPs on request.  
Private Network refers to generators with self-serve private load behind a single meter at the point of injection into the ERCOT grid.

**LEGEND:**

Supplied by/Received by

ERCOT - ERCOT Independent System Operator

QSE - Qualified Scheduling Entity

TDSP - Transmission, Distribution Service Provider

PGC - Power Generating Company

**Mode of Communication**

Web Portal - Online application available to market participants via the World Wide Web

TCH - Transaction Clearinghouse. The mechanism used to send/receive EDI transactions

API - Programmatic API. A message protocol used to automate data exchange between ERCOT and market participants

ICCP - Inter-Control Center Communication Protocol. A standard protocol used to automate data exchange real-time control information between the ERCOT and participants

RTU - Remote Terminal Unit. Used to gather real-time control/monitoring information.

**Format**

**EDI - Electronic Data Exchange format. EDI formats are specified by the Texas SET working group and are based on standard EDI transaction protocols.**

XML - eXtensible Markup Language. XML is a self-describing meta language used to facilitate the exchange of data. XML will format requests and receive replies using the API.

CSV - Comma Separated Values. A generic file format where elements of data are separated by commas within a file.

Office Document - One of the common Microsoft Office file formats such as MS Word or MS Excel.